

CARFAX Report

US \$44.99

2017 Chrysler Pacifica LX

145,177 mi | VIN: 2C4RC1CG5HR815955

Vehicle Details

CARFAX HAS THE MOST ACCIDENT & DAMAGE INFORMATION



DAMAGE

Damage Reported

CARFAX VALUE \$7,020

Update Trim & Options

19 Service History Records

3 Previous Owners

Types of Owners: Commercial, Personal

Last Owned in Washington

38 Detailed Records Available

This CARFAX Vehicle History Report is based only on information supplied to CARFAX and available as of 4/29/26 at 11:02:35 AM (CDT). Other information about this vehicle, including problems, may not have been reported to CARFAX. Use this report as one important tool, along with a vehicle inspection and test drive, to make a better decision about your next used car.

CARFAX Accident / Damage History

Not all accidents / issues are reported to CARFAX

Event 1

06/01/2024

Damage reported

View More Details

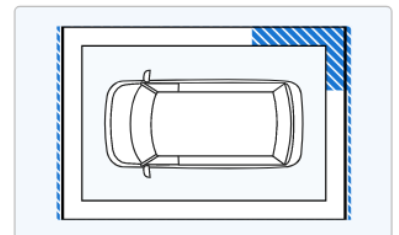

Event 2

04/03/2026

Biohazard vehicle reported

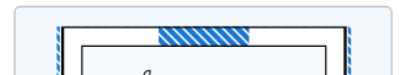

04/03/2026

Biohazard vehicle reported

-Damage reported

[View More Details >](#)

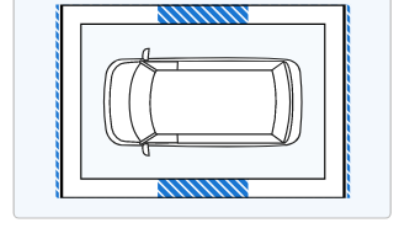

CARFAX History-Based Value Report

\$7,020

CARFAX Retail Value

History events affecting this vehicle's value

Service History

Damage

CARFAX Additional History

Not all accidents / issues are reported to CARFAX

	Owner 1	Owner 2	Owner 3
Total Loss ⓘ No total loss reported to CARFAX.	✓	✓	✓
Structural Damage ⓘ CARFAX recommends that you have this vehicle inspected by a collision repair specialist.	✓	✓	✓
Airbag Deployment ⓘ No airbag deployment reported to CARFAX.	✓	✓	✓
Odometer Check ⓘ No indication of an odometer rollback.	✓	✓	✓
Accident / Damage ⓘ Damage reported: 06/01/2024 and 04/03/2026.	✓	Damage Reported	Damage Reported
Manufacturer Recall ⓘ No open recalls reported to CARFAX.	No Recalls Reported	No Recalls Reported	No Recalls Reported
Basic Warranty ⓘ Original warranty estimated to have expired.	Warranty Expired	Warranty Expired	Warranty Expired

CARFAX Title History

CARFAX guarantees the information in this section

	Owner 1	Owner 2	Owner 3
Damage Brands ⓘ Salvage Junk Rebuilt Fire Flood Hail Lemon	✓	✓	✓
Odometer Brands ⓘ Not Actual Mileage Exceeds Mechanical Limits	✓	✓	✓



GUARANTEED - None of these title problems were reported by a U.S. state Department of Motor Vehicles (DMV). If you find that any of these title problems were reported by a DMV and not included in this report, you may qualify.

[View Terms](#) | [View Certificate](#)



Ownership History

The number of owners is estimated

	Owner 1	Owner 2	Owner 3
Year purchased	2017	2022	2024
Type of owner	Commercial	Personal	Personal
Estimated length of ownership	4 years	1 yr. 5 mo.	1 yr. 9 mo.
Owned in the following states/provinces	Washington	Washington	Washington
Estimated miles driven per year	28,852/yr	---	---
Last reported odometer reading	117,726	145,177	---



Detailed History

[Glossary](#)













Owner 1

Purchased: 2017

Commercial Vehicle





28,852 mi/yr

Date	Mileage	Source	Comments
Not Reported		FCA	
07/31/2017 	28	Renton Chrysler Jeep Dodge Ram Renton, WA 425-226-0066 chryslerjeepdodgeramofrenton.com 1,377 Customer Favorites	Vehicle serviced -Pre-delivery inspection completed
09/15/2017		Washington Motor Vehicle Dept. Woodinville, WA Title #1720495862	Title issued or updated -First owner reported -Loan or lien reported -Titled or registered as commercial vehicle
09/26/2017		Fleet Management Co. Woodinville, WA	Vehicle purchased by fleet lease company
09/26/2017 		Renton Chrysler Jeep Dodge Ram Renton, WA 425-226-0066 chryslerjeepdodgeramofrenton.com 1,377 Customer Favorites	Vehicle serviced -Pre-delivery inspection completed
12/11/2017 	6,155	Service Facility	Vehicle serviced
03/13/2018 	12,938	Service Facility	Vehicle serviced
07/11/2018		Washington Motor Vehicle Dept. Woodinville, WA Title #1720495862	Registration issued or renewed -Loan or lien reported
07/19/2018 	23,875	Service Facility	Vehicle serviced
11/16/2018 	33,197	Service Facility	Vehicle serviced

11/16/2018	33,197	Service Facility	Vehicle serviced
			
02/04/2019	35,595	Service Facility Renton, WA	Vehicle serviced -Tires serviced
			
03/27/2019	38,937	Service Facility Auburn Hills, MI	Vehicle serviced
			
06/05/2019	43,928	Service Facility Marysville, WA	Vehicle serviced -Tires serviced
			
07/10/2019		Washington Motor Vehicle Dept. Woodinville, WA Title #1720495862	Registration issued or renewed
11/06/2019	53,615	Service Facility Marysville, WA	Vehicle serviced -Tires serviced
			
02/26/2020	60,590	Service Facility Arlington, WA	Vehicle serviced -Cranking system serviced -Automatic transmission serviced -Steering system serviced
			
07/29/2020	73,983	Valvoline Instant Oil Change East Wenatchee, WA 509-888-9500 vioc.com  137 Customer Favorites	Vehicle serviced -Oil and filter changed
			
01/20/2021		Washington Motor Vehicle Dept. Woodinville, WA Title #1720495862	Registration issued or renewed
02/24/2021	94,624	Valvoline Instant Oil Change East Wenatchee, WA 509-888-9500 vioc.com  137 Customer Favorites	Vehicle serviced -Oil and filter changed
			
04/29/2021		Service Facility Columbus, OH	Vehicle serviced -Glass checked
			
06/22/2021	105,088	Service Facility Wenatchee, WA	Vehicle serviced -Tires serviced -Brakes serviced
			
08/05/2021		Washington Motor Vehicle Dept. Moses Lake, WA Title #1720495862	Registration issued or renewed -Registration updated when owner moved the vehicle to a new location
10/13/2021	117,702	Auto Auction	Vehicle sold
			<div style="border: 1px solid #007bff; padding: 5px; width: fit-content;">Millions of used vehicles are bought and sold at auction every year.</div>
10/16/2021	117,709	Zag Motors Lynnwood Lynnwood, WA	Vehicle offered for sale
10/18/2021		Fleet Management Co. Moses Lake, WA	Vehicle Sold

10/18/2021		Fleet Management Co. Moses Lake, WA	Vehicle Sold
03/07/2022	117,726	SouthwestRe Everett, WA	Service contract issued

 **Owner 2** Personal Vehicle
Purchased: 2022

Date	Mileage	Source	Comments
03/24/2022		Washington Motor Vehicle Dept. Everett, WA Title #1836657118	Title issued or updated -New owner reported -Loan or lien reported
05/24/2022 		Walmart Auto Care Center Everett, WA 425-923-1750 https://www.walmart.com	Vehicle serviced -Oil and filter changed
08/23/2022		Washington Motor Vehicle Dept. Everett, WA Title #1847545442	Title issued or updated -Correction to record -Duplicate title issued -Loan or lien reported
09/25/2022 	134,215	Walmart Auto Care Center Everett, WA 425-923-1750 https://www.walmart.com	Vehicle serviced -Oil and filter changed
12/23/2022 	141,034	Walmart Auto Care Center Everett, WA 425-923-1750 https://www.walmart.com	Vehicle serviced -Oil and filter changed
06/23/2023 	145,177	Dwayne Lane's Chrysler Dodge Jeep RAM Everett, WA 425-353-3855 dwaynelanechryslerjeepdodge.com  2,548 Customer Favorites	Vehicle serviced
09/12/2023		Online Listing	Vehicle offered for sale
11/03/2023		Auto Auction	Vehicle offered for sale

06/01/2024 		Damage Report	Damage reported -Damage to right rear
--	--	---------------	---

**CARFAX HAS THE MOST
ACCIDENT & DAMAGE
INFORMATION**

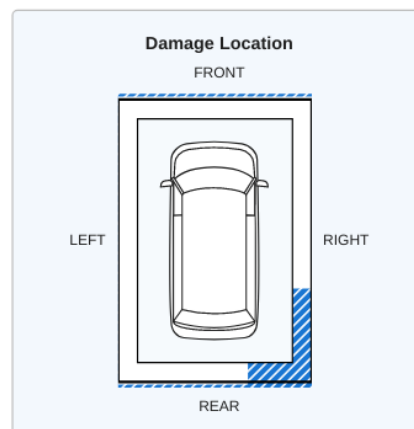

Not all damage is caused by an accident. Get the car inspected before you buy. [Learn More](#)



Not all damage is caused by an accident. Get the car inspected before you buy. [Learn More](#)

Owner 3
Purchased: 2024

Personal Vehicle

Date	Mileage	Source	Comments
06/28/2024		Washington Motor Vehicle Dept. Bellevue, WA Title #1889632759	Title issued or updated -New owner reported
06/24/2025		Washington Motor Vehicle Dept. Bothell, WA Title #1889632759	Registration issued or renewed -Registration updated when owner moved the vehicle to a new location

04/03/2026



Damage Report

Biohazard vehicle reported

- Damage reported
- Damage to right side
- Damage to left side

CARFAX HAS THE MOST ACCIDENT & DAMAGE INFORMATION

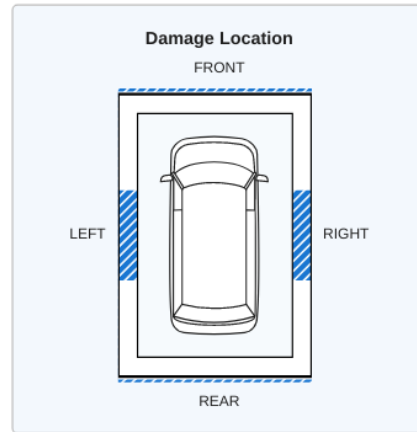

Not all damage is caused by an accident. Get the car inspected before you buy. [Learn More](#)

Have Questions? Consumers, please visit our Help Center at www.carfax.com. Dealers or Subscribers, please visit our Help Center at www.carfaxonline.com.

Commercial

Vehicle was registered for business purposes.

Damage Indicator

Damage can be a result of many different types of events. Examples include contact with objects (other cars, trees, traffic signs, road debris, etc), vandalism, or weather-related events. Not every damage event is reported to CARFAX. As details about the damage event become available, those additional details are added to the CARFAX Vehicle History Report. CARFAX recommends that you have this vehicle inspected by a qualified mechanic.

- This CARFAX Vehicle History Report is based only on information supplied to CARFAX and available as of 4/29/26 at 11:02:35 AM (CDT). Other information about this vehicle, including problems, may not have been reported to CARFAX. Use this report as one important tool, along with a vehicle inspection and test drive, to make a better decision about your next used car.

First Owner

When the first owner(s) obtains a title from a Department of Motor Vehicles as proof of ownership.

New Owner Reported

When a vehicle is sold to a new owner, the Title must be transferred to the new owner(s) at a Department of Motor Vehicles.

When a vehicle is sold to a new owner, the Title must be transferred to the new owner(s) at a Department of Motor Vehicles.

Ownership History

CARFAX defines an owner as an individual or business that possesses and uses a vehicle. Not all title transactions represent changes in ownership. To provide estimated number of owners, CARFAX proprietary technology analyzes all the events in a vehicle history. Estimated ownership is available for vehicles manufactured after 1991 and titled solely in the US including Puerto Rico. Dealers sometimes opt to take ownership of a vehicle and are required to in the following states: Maine, Massachusetts, New Jersey, Ohio, Oklahoma, Pennsylvania and South Dakota. Please consider this as you review a vehicle's estimated ownership history.

Title Issued

A state issues a title to provide a vehicle owner with proof of ownership. Each title has a unique number. Each title or registration record on a CARFAX report does not necessarily indicate a change in ownership. In Canada, a registration and bill of sale are used as proof of ownership.

[Full Glossary](#)

Follow
Us:



facebook.com/CARFAX



[@CARFAXinc](https://twitter.com/CARFAXinc)



[About CARFAX](#)

CARFAX DEPENDS ON ITS SOURCES FOR THE ACCURACY AND RELIABILITY OF ITS INFORMATION. THEREFORE, NO RESPONSIBILITY IS ASSUMED BY CARFAX OR ITS AGENTS FOR ERRORS OR OMISSIONS IN THIS REPORT. CARFAX FURTHER EXPRESSLY DISCLAIMS ALL WARRANTIES, EXPRESS OR IMPLIED, INCLUDING ANY IMPLIED WARRANTIES OF MERCHANTABILITY OR FITNESS FOR A PARTICULAR PURPOSE.

© 2026 CARFAX, Inc., part of S&P Global. All rights reserved.
4/29/26 11:02:35 AM (CDT)

I have reviewed and received a copy of the CARFAX Vehicle History Report for this 2017 CHRYSLER PACIFICA vehicle (VIN: 2C4RC1CG5HR815955), which is based on information supplied to CARFAX and available as of 4/29/26 at 12:02 PM (EDT).

Customer Signature

Date

Dealer Signature

Date