

CARFAX Report

US \$44.99

2019 Subaru Outback 2.5I Limited

74,181 mi | VIN: 4S4BSAJC2K3241489

Vehicle Details

CARFAX HAS THE MOST ACCIDENT & DAMAGE INFORMATION



BRANDED TITLE

Rebuilt, Salvage

CARFAX VALUE \$15,040

Update Trim & Options

25 Service History Records

At Least 1 Open Recall

5 Previous Owners

Personal Vehicle

Last Owned in Florida

This CARFAX Vehicle History Report is based only on information supplied to CARFAX and available as of 5/5/26 at 7:32:19 AM (CDT). Other information about this vehicle, including problems, may not have been reported to CARFAX. Use this report as one important tool, along with a vehicle inspection and test drive, to make a better decision about your next used car.

CARFAX Accident / Damage History

Not all accidents / issues are reported to CARFAX

Event 1

09/13/2019

Accident reported with another motor vehicle

- Disabling damage reported
-Airbag deployed

View More Details

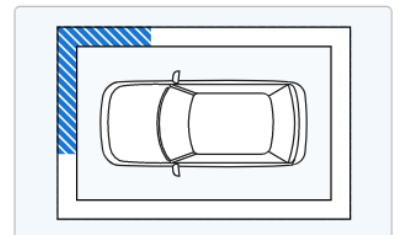

Event 2

04/08/2026

Damage reported

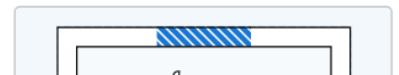

Damage reported

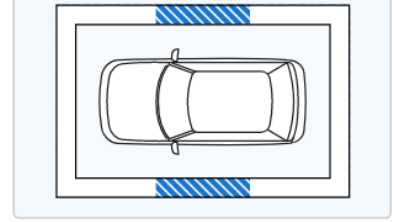
[View More Details >](#)
CARFAX Recent Service Highlights

Key services performed in the last 12 months

| Service | Comments | Date | |
|--|---------------------------------------|------------|-----------------------------------|
| Oil | ✓ Oil and filter changed | 12/19/2025 | View Details > |
| Tires | ✓ Tires rotated | 07/24/2025 | View Details > |
| Flushes | ✓ Transfer case fluid flushed/changed | 07/08/2025 | View Details > |
|  <div style="border: 1px solid #0070C0; padding: 5px; display: inline-block;"> This car has been recently serviced. That's a good thing! </div> | | | |

CARFAX History-Based Value Report

\$15,040

CARFAX Retail Value

History events affecting this vehicle's value

- Service History
- Personal Vehicle
- Damage Brand
- Airbag Deployed

CARFAX Additional History

Not all accidents / issues are reported to CARFAX





| | Owners 1-3 | Owner 4 | Owner 5 |
|---|-----------------------------------|-------------------------------|-------------------------------|
| Total Loss No total loss reported to CARFAX. | ✓ | ✓ | ✓ |
| Structural Damage CARFAX recommends that you have this vehicle inspected by a collision repair specialist. | ✓ | ✓ | ✓ |
| Airbag Deployment Airbag deployment reported: 09/13/2019. | Airbag Deployment | No New Issues Reported | No New Issues Reported |
| Odometer Check No indication of an odometer rollback. | ✓ | ✓ | ✓ |
| Accident / Damage DMV title problems reported. Accident reported: 09/13/2019. Damage reported: 04/08/2026. | Severe Damage | Severe Damage | Severe Damage |
| Manufacturer Recall At least 1 manufacturer recall requires repair. Most recalls can be | Recall Reported | No New Recalls Reported | No New Recalls Reported |









| | | | |
|--|---------------------------------|-------------------------|-------------------------|
| Manufacturer Recall ⓘ At least 1 manufacturer recall requires repair. Most recalls can be repaired free of charge. | Recall Reported | No New Recalls Reported | No New Recalls Reported |
| Basic Warranty ⓘ Original manufacturer warranty likely voided by manufacturer. | Warranty Voided | Warranty Voided | Warranty Voided |

| CARFAX Title History | 👤 Owners 1-3 | 👤 Owner 4 | 👤 Owner 5 |
|---|--------------------------------|--------------------------------|--------------------------------|
| Damage Brands ⓘ Salvage Junk Rebuilt Fire Flood Hail Lemon | Alert! Problem Found | Alert! Problem Found | Alert! Problem Found |
| Odometer Brands ⓘ Not Actual Mileage Exceeds Mechanical Limits | No Problem | No Problem | No Problem |
|  ALERT! - Severe problems were reported by a state Department of Motor Vehicles (DMV). This vehicle does not qualify for the CARFAX Buyback Guarantee. | | | |

| CARFAX Ownership History <small>The number of owners is estimated</small> | 👤 Owners 1-3 | 👤 Owner 4 | 👤 Owner 5 |
|---|-----------------------------|-------------|--------------|
| Year purchased | 2018 | 2020 | 2021 |
| Type of owner | Personal | Personal | Personal |
| Estimated length of ownership | 1 yr. 1 mo. | 1 yr. 4 mo. | 4 yrs. 5 mo. |
| Owned in the following states/provinces | See Details | Illinois | Florida |
| Estimated miles driven per year | --- | 12,733/yr | 12,058/yr |
| Last reported odometer reading | 20,003 | 33,499 | 74,181 |



CARFAX Detailed History [Glossary](#)

|  Owner 1 Purchased: 2018 | | | Personal Vehicle |
|---|---------|---|---|
| Date | Mileage | Source | Comments |
| 10/17/2018 | 1 | Fox Subaru Grand Rapids, MI 616-236-5306 foxsubaru.com/  233 Customer Favorites | Vehicle offered for sale |
| 10/23/2018  | | Fox Subaru Grand Rapids, MI 616-236-5306 foxsubaru.com/  233 Customer Favorites | Vehicle serviced -Pre-delivery inspection completed |
| 12/04/2018 | 7 | Michigan Motor Vehicle Dept. Williamston, MI Title #603G3382677 | Title issued or updated -Registration issued or renewed -First owner reported -Titled or registered as personal vehicle |
| 02/12/2019 | 3,511 | Subaru of Jacksonville | Vehicle serviced |

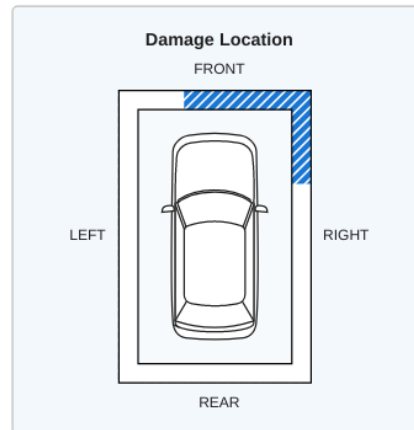

| | | | |
|---|--------|---|---|
| 02/12/2019  | 3,511 | Subaru of Jacksonville Jacksonville, FL 904-641-6455 subaruofjacksonville.com/  10,515 Customer Favorites | Vehicle serviced -Maintenance inspection completed -Oil and filter changed -Tires rotated |
| 03/08/2019  | 6,029 | Williams Hyundai Lansing, MI 517-484-1341 lansinghyundai.com  254 Customer Favorites | Vehicle serviced -Maintenance inspection completed -Tire repaired |
| 05/13/2019 | | Michigan Motor Vehicle Dept. Williamston, MI | Registration issued or renewed |
| 05/21/2019  | 9,595 | Fox Subaru Grand Rapids, MI 616-236-5306 foxsubaru.com/  233 Customer Favorites | Vehicle serviced -Maintenance inspection completed -Oil and filter changed -Tires rotated |
| 08/06/2019  | 16,036 | Williams Hyundai Lansing, MI 517-484-1341 lansinghyundai.com  254 Customer Favorites | Vehicle serviced -Maintenance inspection completed -Brakes checked -Oil and filter changed -Power steering checked -Tires rotated |
| 09/13/2019  | | Damage Report | Accident reported with another motor vehicle -Damage to right front -Damage to front -Disabling damage reported -Airbag deployed CARFAX Airbag Tips |

CARFAX HAS THE MOST ACCIDENT & DAMAGE INFORMATION



|  Owner 2 Purchased: 2019 | Personal Vehicle | | |
|---|------------------|--|--|
| Date | Mileage | Source | Comments |
| 11/05/2019  | | Michigan Motor Vehicle Dept. Auburn Hills, MI Title #MI0003349343 | Vehicle purchase reported -New owner reported - SALVAGE TITLE/CERTIFICATE ISSUED |

|  Owner 3 Purchased: 2020 | Personal Vehicle | | |
|---|------------------|--------|----------|
| Date | Mileage | Source | Comments |

| Date | Mileage | Source | Comments |
|--|---------|--|--|
| 01/07/2020  | 20,003 | Michigan Motor Vehicle Dept. Auburn Hills, MI Title #MI0004133580 | Correction to record -New owner reported - SALVAGE TITLE/CERTIFICATE ISSUED |
| 01/28/2020 | | Indiana Motor Vehicle Dept. | Vehicle purchase reported |
| 03/17/2020  | | Indiana Motor Vehicle Dept. Carmel, IN Title #20811053000289 | Dealer took title of this vehicle while it was in inventory - REBUILT TITLE ISSUED |
| 04/16/2020 | | Subaru of America | Manufacturer Safety recall issued -NHTSA #20V218000 -Recall #WRD20 19 LEGACY & OUTBACK 2.5L FUEL PUMP REPLACEMENT -Status: Remedy Available Click Here or email us at customers@subaru.com to locate an authorized Subaru dealership near you to obtain more information about this recall. + Learn more about this recall |
| 05/18/2020 | | Illinois Motor Vehicle Dept. | Vehicle purchase reported |
| 06/02/2020 | | Illinois Motor Vehicle Dept. Wheaton, IL | Registration issued or renewed |











Owner 4

Purchased: 2020

Personal Vehicle

12,733 mi/yr

| Date | Mileage | Source | Comments |
|--|---------|--|---|
| 06/03/2020  | 20,277 | Illinois Motor Vehicle Dept. Wheaton, IL Title #201556928150 | New owner reported - REBUILT TITLE ISSUED -Vehicle color noted as Brown |
| 07/01/2020  | 22,205 | GF Auto Repair Wheaton, IL 630-510-7700 gfautorepair.com  15 Customer Favorites | Vehicle serviced -Fluids checked -Oil and filter changed -Trailer hitch installed |
| 08/20/2020  | 23,430 | Napleton's Schaumburg Subaru Schaumburg, IL 847-884-6000 napletonsschaumburgsubaru.com/  11 Customer Favorites | Vehicle serviced |
| 11/16/2020  | 26,813 | Merlin 200,000 Mile Shops Wheaton, IL 630-871-9800 merlin.com  413 Customer Favorites | Vehicle serviced -Oil and filter changed |
| 04/16/2021 | | Illinois Motor Vehicle Dept. Wheaton, IL | Registration issued or renewed -Correction to record |
| 06/17/2021  | 33,499 | GF Auto Repair Wheaton, IL 630-510-7700 gfautorepair.com  15 Customer Favorites | Vehicle serviced -Fluids checked -Oil and filter changed |











630-510-7700
gfautorepair.com













♥ 15 Customer Favorites

Oil and filter changed

 **Owner 5**
Purchased: 2021

Personal Vehicle
12,058 mi/yr

| Date | Mileage | Source | Comments |
|--|---------|--|---|
| 10/25/2021  | 40,120 | Florida Motor Vehicle Dept. Venice, FL Title #0144482808 | Vehicle purchase reported -New owner reported - SALVAGE TITLE/CERTIFICATE ISSUED - REBUILT TITLE ISSUED -Titled or registered as personal vehicle -Vehicle color noted as Brown |
| 12/04/2021  | 41,897 | JSN Auto Repair Venice Island Venice Island, FL 941-485-5823 jsnautorepair.com/ ♥ 8 Customer Favorites | Vehicle serviced -Oil and filter changed |
| 05/26/2022  | 47,556 | GF Auto Repair Wheaton, IL 630-510-7700 gfautorepair.com ♥ 15 Customer Favorites | Vehicle serviced -Brakes checked -Brakes serviced -Drivability/performance checked -Front brake pads replaced -Front brake rotor(s) replaced |
| 06/18/2022  | 49,871 | JSN Auto Repair Venice Island Venice Island, FL 941-485-5823 jsnautorepair.com/ ♥ 8 Customer Favorites | Vehicle serviced -Oil and filter changed |
| 07/28/2022  | 51,714 | JSN Auto Repair Venice Island Venice Island, FL 941-485-5823 jsnautorepair.com/ ♥ 8 Customer Favorites | Vehicle serviced |
| 12/23/2022  | 57,207 | JSN Auto Repair Venice Island Venice Island, FL 941-485-5823 jsnautorepair.com/ ♥ 8 Customer Favorites | Vehicle serviced -Oil and filter changed |
| 03/13/2023  | | Florida Motor Vehicle Dept. Venice, FL Title #0144482808 | SALVAGE TITLE/CERTIFICATE ISSUED - REBUILT TITLE ISSUED -Titled or registered as personal vehicle -Vehicle color noted as Brown |
| 06/05/2023  | 61,660 | American Import Auto Inc. Venice, FL 941-220-5898 americanimportrepair.com/ ♥ 1 Customer Favorite | Vehicle serviced -Maintenance inspection completed -A/C condenser replaced -Front differential fluid flushed/changed |
| 06/23/2023  | 62,049 | JSN Auto Repair Venice Island Venice Island, FL 941-485-5823 jsnautorepair.com/ ♥ 8 Customer Favorites | Vehicle serviced -Four wheel alignment performed -Oil and filter changed |
| 03/28/2024  | 70,682 | Valvoline Instant Oil Change Venice, FL 941-492-5210 vioc.com ♥ 81 Customer Favorites | Vehicle serviced -Differential fluid flushed/changed -Oil and filter changed -Rear differential fluid flushed/changed |

| | | | |
|--|--------|---|---|
| 04/05/2024  | | Jon's Auto Venice, FL 941-800-4359 ♥ 5 Customer Favorites | Vehicle serviced - Spark plug(s) replaced - Valve cover(s) replaced |
| 04/19/2024  | | Florida Motor Vehicle Dept. Venice, FL Title #0144482808 | SALVAGE TITLE/CERTIFICATE ISSUED -REBUILT TITLE ISSUED - Titled or registered as personal vehicle - Vehicle color noted as Brown |
| 07/09/2024  | | Jon's Auto Venice, FL 941-800-4359 ♥ 5 Customer Favorites | Vehicle serviced |
| 07/19/2024  | | Jon's Auto Venice, FL 941-800-4359 ♥ 5 Customer Favorites | Vehicle serviced - Thermostat replaced |
| 08/21/2024  | 74,181 | Valvoline Instant Oil Change Venice, FL 941-492-5210 vioc.com ♥ 81 Customer Favorites | Vehicle serviced - Oil and filter changed |
| 01/13/2025  | | Jon's Auto Venice, FL 941-800-4359 ♥ 5 Customer Favorites | Vehicle serviced - Antifreeze/coolant flushed/changed - Engine replaced - Oil and filter changed - Radiator replaced - Spark plug(s) replaced |
| 04/07/2025  | | Florida Motor Vehicle Dept. Venice, FL Title #0144482808 | SALVAGE TITLE/CERTIFICATE ISSUED -REBUILT TITLE ISSUED - Titled or registered as personal vehicle - Vehicle color noted as Brown |
| 07/08/2025  | | Jon's Auto Venice, FL 941-800-4359 ♥ 5 Customer Favorites | Vehicle serviced - Battery replaced - Differential checked - Differential replaced - Transfer case fluid flushed/changed - Wheel bearing(s)/hub(s) replaced |
| 07/24/2025  | | Valvoline Instant Oil Change Venice, FL 941-492-5210 vioc.com ♥ 81 Customer Favorites | Vehicle serviced - Oil and filter changed - Tire condition and pressure checked - Tires rotated |
| 12/19/2025  | | Jon's Auto Venice, FL 941-800-4359 ♥ 5 Customer Favorites | Vehicle serviced - Oil and filter changed |
| 03/30/2026  | | Florida Motor Vehicle Dept. Venice, FL Title #0144482808 | SALVAGE TITLE/CERTIFICATE ISSUED -REBUILT TITLE ISSUED - Titled or registered as personal vehicle - Vehicle color noted as Brown |
| 04/08/2026  | | Damage Report | Damage reported - Damage to right side - Damage to left side |

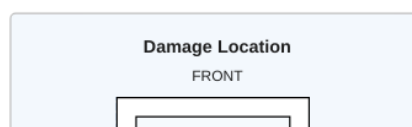

**CARFAX HAS THE MOST
ACCIDENT & DAMAGE
INFORMATION**

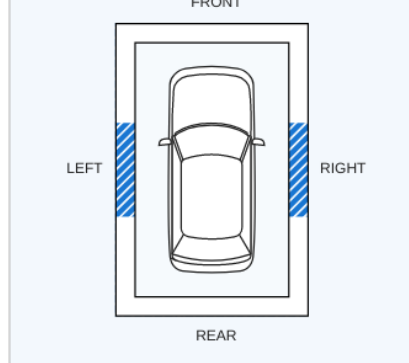

Not all damage is caused by an accident. Get the car inspected before you buy. [Learn More](#)

Have Questions? Consumers, please visit our Help Center at www.carfax.com. Dealers or Subscribers, please visit our Help Center at www.carfaxonline.com.

Accident Indicator

CARFAX receives information about accidents in all 50 states, the District of Columbia and Canada.

Not every accident is reported to CARFAX. As details about the accident become available, those additional details are added to the CARFAX Vehicle History Report. CARFAX recommends that you have this vehicle inspected by a qualified mechanic.

- According to the National Safety Council, Injury Facts, 2021 edition, 5% of the 276 million registered vehicles in the U.S. were involved in an accident in 2019. Over 77% of these were considered minor or moderate.
- This CARFAX Vehicle History Report is based only on information supplied to CARFAX and available as of 5/5/26 at 7:32:19 AM (CDT). Other information about this vehicle, including problems, may not have been reported to CARFAX. Use this report as one important tool, along with a vehicle inspection and test drive, to make a better decision about your next used car.

Airbag Deployment

Occurs when the driver, passenger or side airbag has been used or deployed during a crash or other incident. If an airbag has been deployed, it must be replaced by a qualified technician. Have this car inspected by a mechanic prior to purchase.

Damage Indicator

Damage can be a result of many different types of events. Examples include contact with objects (other cars, trees, traffic signs, road debris, etc), vandalism, or weather-related events. Not every damage event is reported to CARFAX. As details about the damage event become available, those additional details are added to the CARFAX Vehicle History Report. CARFAX recommends that you have this vehicle inspected by a qualified mechanic.

- This CARFAX Vehicle History Report is based only on information supplied to CARFAX and available as of 5/5/26 at 7:32:19 AM (CDT). Other information about this vehicle, including problems, may not have been reported to CARFAX. Use this report as one important tool, along with a vehicle inspection and test drive, to make a better decision about your next used car.

First Owner

When the first owner(s) obtains a title from a Department of Motor Vehicles as proof of ownership.

Manufacturer Recall

Automobile manufacturers issue recall notices to inform vehicle owners of a safety defect or failure to meet minimum federal safety or emissions standards. Manufacturer recalls are repaired at no cost to the customer.

New Owner Reported

When a vehicle is sold to a new owner, the Title must be transferred to the new owner(s) at a Department of Motor Vehicles.

Ownership History

CARFAX defines an owner as an individual or business that possesses and uses a vehicle. Not all title transactions represent changes in ownership. To provide estimated number of owners, CARFAX proprietary technology analyzes all the events in a vehicle history. Estimated ownership is available for vehicles manufactured after 1991 and titled solely in the US including Puerto Rico. Dealers sometimes opt to take ownership of a vehicle and are required to in the following states: Maine, Massachusetts, New Jersey, Ohio, Oklahoma, Pennsylvania and South Dakota. Please consider this as you review a vehicle's estimated ownership history.

Rebuilt/Reconstructed Title

A Rebuilt/Reconstructed vehicle is a salvage vehicle that has been repaired and restored to operation. These vehicles are often severely damaged before they are rebuilt and refurbished parts are typically used during reconstruction. In most states, an inspection of the vehicle is required before the vehicle is allowed to return to the road.

return to the road.

Salvage Title

A Salvage Title is issued on a vehicle damaged to the extent that the cost of repairing the vehicle exceeds approximately 75% of its pre-damage value. This damage threshold may vary by state. Some states treat Junk titles the same as Salvage but the majority use this title to indicate that a vehicle is not road worthy and cannot be titled again in that state. The following eleven states also use Salvage titles to identify stolen vehicles - AZ, FL, GA, IL, MD, MN, NJ, NM, NY, OK and OR.

Title Issued

A state issues a title to provide a vehicle owner with proof of ownership. Each title has a unique number. Each title or registration record on a CARFAX report does not necessarily indicate a change in ownership. In Canada, a registration and bill of sale are used as proof of ownership.

[Full Glossary](#)

Follow Us:



facebook.com/CARFAX



[@CARFAXinc](https://twitter.com/CARFAXinc)



[About CARFAX](#)

CARFAX DEPENDS ON ITS SOURCES FOR THE ACCURACY AND RELIABILITY OF ITS INFORMATION. THEREFORE, NO RESPONSIBILITY IS ASSUMED BY CARFAX OR ITS AGENTS FOR ERRORS OR OMISSIONS IN THIS REPORT. CARFAX FURTHER EXPRESSLY DISCLAIMS ALL WARRANTIES, EXPRESS OR IMPLIED, INCLUDING ANY IMPLIED WARRANTIES OF MERCHANTABILITY OR FITNESS FOR A PARTICULAR PURPOSE.

© 2026 CARFAX, Inc., part of S&P Global. All rights reserved.

5/5/26 7:32:19 AM (CDT)

I have reviewed and received a copy of the CARFAX Vehicle History Report for this 2019 SUBARU OUTBACK vehicle (VIN: 4S4BSAJC2K3241489), which is based on information supplied to CARFAX and available as of 5/5/26 at 8:32 AM (EDT).

Customer Signature

Date

Dealer Signature

Date