

2016 BMW X5 Xdrive40E

106,367 mi | VIN: 5UXKT0C54G0S79081

Vehicle Details

CARFAX HAS THE MOST ACCIDENT & DAMAGE INFORMATION



BRANDED TITLE

Salvage

CARFAX VALUE \$11,050

Update Trim & Options

10 Service History Records

At Least 1 Open Recall

2 Previous Owners

Types of Owners: Personal Lease, Personal

Last Owned in California

This CARFAX Vehicle History Report is based only on information supplied to CARFAX and available as of 4/22/26 at 11:48:29 AM (CDT). Other information about this vehicle, including problems, may not have been reported to CARFAX. Use this report as one important tool, along with a vehicle inspection and test drive, to make a better decision about your next used car.

CARFAX Accident / Damage History

Not all accidents / issues are reported to CARFAX

Event 1

11/02/2018

Damage reported: minor damage

View More Details

Damage Severity Scale



Minor

Moderate

Severe

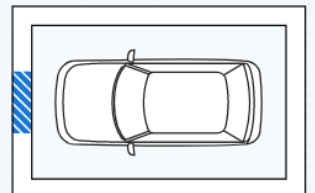

Event 2

09/08/2020

Accident reported: minor damage ⓘ

- Airbags did not deploy

[View More Details >](#)

Damage Severity Scale

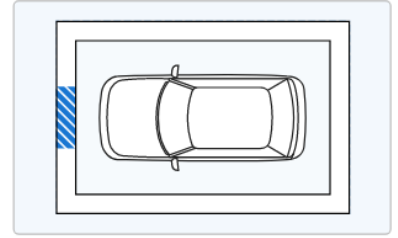
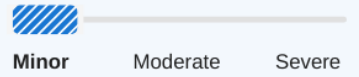

Event 3

04/14/2026

TOTAL LOSS VEHICLE

- Accident reported

[View More Details >](#)

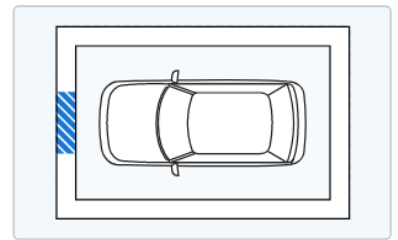

CARFAX History-Based Value Report

\$11,050

CARFAX Retail Value

History events affecting this vehicle's value

- Service History
- Personal Vehicle
- Salvage Brand
- Open Recall

CARFAX Additional History

Not all accidents / issues are reported to CARFAX

	Owner 1	Owner 2
<p>Total Loss ⓘ</p> <p>Total Loss Reported: 04/14/2026.</p>	<input checked="" type="checkbox"/>	Total Loss Reported
<p>Structural Damage ⓘ</p> <p>CARFAX recommends that you have this vehicle inspected by a collision repair specialist.</p>	<input checked="" type="checkbox"/>	<input checked="" type="checkbox"/>
<p>Airbag Deployment ⓘ</p> <p>No airbag deployment reported to CARFAX.</p>	<input checked="" type="checkbox"/>	<input checked="" type="checkbox"/>
<p>Odometer Check ⓘ</p> <p>No indication of an odometer rollback.</p>	<input checked="" type="checkbox"/>	<input checked="" type="checkbox"/>
<p>Accident / Damage ⓘ</p> <p>DMV title problems reported. Damage reported: 11/02/2018. Accidents</p>	<input checked="" type="checkbox"/>	Severe Damage

Accident / Damage ⓘ DMV title problems reported. Damage reported: 11/02/2018. Accidents reported: 09/08/2020 and 04/14/2026.	✓	Severe Damage
Manufacturer Recall ⓘ At least 1 manufacturer recall requires service. Locate an authorized BMW dealer near you to schedule an appointment.	No Recalls Reported	Recall Reported
Basic Warranty ⓘ Original manufacturer warranty likely voided by manufacturer.	✓	Warranty Voided

CARFAX Title History	Owner 1	Owner 2
Damage Brands ⓘ Salvage Junk Rebuilt Fire Flood Hail Lemon	No Problem	Alert! Problem Found
Odometer Brands ⓘ Not Actual Mileage Exceeds Mechanical Limits	No Problem	No Problem
 ALERT! - Severe problems were reported by a state Department of Motor Vehicles (DMV). This vehicle does not qualify for the CARFAX Buyback Guarantee.		

CARFAX Ownership History <small>The number of owners is estimated</small>	Owner 1	Owner 2
Year purchased	2016	2017
Type of owner	Personal Lease	Personal
Estimated length of ownership	7 months	9 yrs. 2 mo.
Owned in the following states/provinces	California	California
Estimated miles driven per year	---	9,105/yr
Last reported odometer reading	7,603	106,367

CARFAX Detailed History [Glossary](#)

 Owner 1 Purchased: 2016			Personal Lease Vehicle
Date	Mileage	Source	Comments
06/30/2016	299	California Motor Vehicle Dept. Walnut, CA	Odometer reading reported
08/05/2016		California Motor Vehicle Dept. Walnut, CA	Title issued or updated -First owner reported -Titled or registered as personal lease vehicle -Loan or lien reported
01/04/2017	7,603	California Motor Vehicle Dept. San Gabriel, CA	Odometer reading reported
01/11/2017		California	Title issued or updated











01/11/2017

California
Motor Vehicle Dept.
Walnut, CA

Title issued or updated
-Loan or lien reported

 **Owner 2**
Purchased: 2017

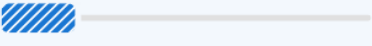
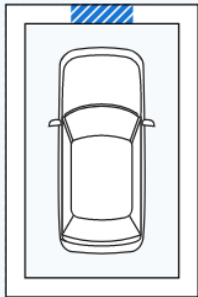
Personal Vehicle
9,105 mi/yr

Date	Mileage	Source	Comments
02/10/2017		California Motor Vehicle Dept. San Gabriel, CA	Title issued or updated -New owner reported -Loan or lien reported
11/18/2017 	29,805	BMW MINI of Monrovia Monrovia, CA 626-358-4269 bmwofmonrovia.net/  16 Customer Favorites	Vehicle serviced -Maintenance inspection completed -Recommended maintenance performed -Cabin air filter replaced/cleaned -Engine checked -Oil and filter changed -Tire condition and pressure checked -Wiper(s) replaced
02/21/2018 	35,951	BMW MINI of Monrovia Monrovia, CA 626-358-4269 bmwofmonrovia.net/  16 Customer Favorites	Vehicle serviced -Recommended maintenance performed -Engine checked -Tire condition and pressure checked
06/01/2018 	39,383	BMW MINI of Monrovia Monrovia, CA 626-358-4269 bmwofmonrovia.net/  16 Customer Favorites	Vehicle serviced -Recommended maintenance performed -A/C and heating system checked -A/C evaporator replaced -Anti-theft/keyless remote battery replaced -Fuel pump replaced -Oil and filter changed -Tire condition and pressure checked
11/01/2018 	44,638	BMW MINI of Monrovia Monrovia, CA 626-358-4269 bmwofmonrovia.net/  16 Customer Favorites	Vehicle serviced -Battery replaced -Four wheel alignment performed -Tire condition and pressure checked
11/02/2018		Damage Report	Damage reported: minor damage  -Damage to front
CARFAX HAS THE MOST ACCIDENT & DAMAGE INFORMATION			
<p>Damage Severity Scale</p>  <p>Minor Moderate Severe</p>			<p>Damage Location</p> 
11/21/2018 	44,685	BMW MINI of Monrovia Monrovia, CA 626-358-4269	Vehicle serviced -Maintenance inspection completed -Battery replaced



Monrovia, CA
626-358-4269
bmwofmonrovia.net/
♥ 16 Customer Favorites

-Maintenance inspection completed
-Battery replaced

12/29/2018 46,874



BMW MINI of Monrovia
Monrovia, CA
626-358-4269
bmwofmonrovia.net/
♥ 16 Customer Favorites

Vehicle serviced
-Recommended maintenance performed
-Cabin air filter replaced/cleaned
-Engine checked
-Oil and filter changed
-Rear wiper blade replaced
-Tire condition and pressure checked
-Wiper(s) replaced

09/08/2020

Damage Report

Accident reported: minor damage ⓘ

-Damage to front
-Airbags did not deploy

CARFAX HAS THE MOST ACCIDENT & DAMAGE INFORMATION

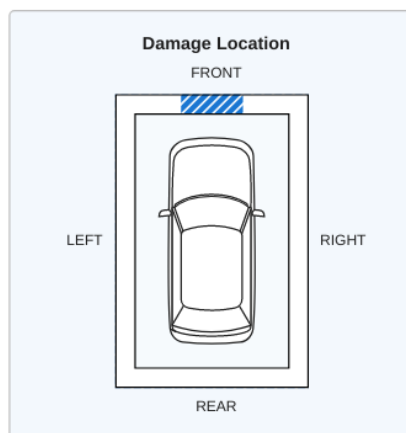
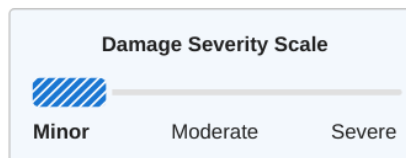

05/14/2021 73,085



Valvoline Instant Oil Change
Lomita, CA
310-626-6307
vioc.com
♥ 244 Customer Favorites

Vehicle serviced
-Oil and filter changed

12/15/2021

California
Motor Vehicle Dept.
Monterey Park, CA

Title issued or updated

-Loan or lien released
-Registration updated when owner moved the vehicle to a new location

04/14/2022 85,732



BMW MINI of Monrovia
Monrovia, CA
626-358-4269
bmwofmonrovia.net/
♥ 16 Customer Favorites

Vehicle serviced
-Maintenance inspection completed
-Recommended maintenance performed
-Tire condition and pressure checked

05/02/2024 100,682

California
Inspection Station

Passed emissions inspection

08/13/2024

BMW of North
America, LLC

Manufacturer Safety recall issued
-NHTSA #24V-608
-Recall #24V-608:474 ENGINE COOLANT PUMP
-Status: Remedy Available

Need more information about this recall? Find an authorized [BMW dealer](#), email CustomerRelations@bmwusa.com, or call 1-800-525-7417

[+ Learn more about this recall](#)

03/14/2025 102,955



BMW MINI of Monrovia
Monrovia, CA
626-358-4269

Vehicle serviced
-Maintenance inspection completed
-Battery/charging system checked



Monrovia, CA
626-358-4269
bmwofmonrovia.net/
❤️ 16 Customer Favorites

-Maintenance inspection completed
-Battery/charging system checked
-Battery replaced
-Tire condition and pressure checked

03/18/2025



OC Imports Auto Reconditioning Center
Gardena, CA
310-819-6681

Vehicle serviced
-Battery/charging system checked
-Battery replaced

04/14/2026



Damage Report

TOTAL LOSS VEHICLE
-Accident reported
-Damage to front

CARFAX HAS THE MOST ACCIDENT & DAMAGE INFORMATION

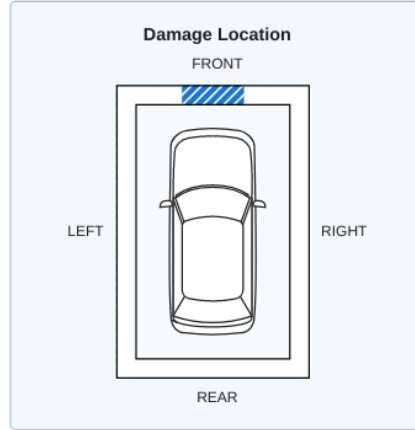

There are many reasons an insurance company will declare a vehicle a total loss. Have this vehicle inspected by a qualified technician before you buy. [Learn More](#)

04/14/2026

California Motor Vehicle Dept.

Title or registration issued to insurance company

04/14/2026

106,367

California Motor Vehicle Dept.
Rancho Cordova, CA

Dealer took title of this vehicle while it was in inventory
-SALVAGE TITLE/CERTIFICATE ISSUED

04/16/2026



Damage Report

SALVAGE TITLE/CERTIFICATE ISSUED

Have Questions? Consumers, please visit our Help Center at www.carfax.com. Dealers or Subscribers, please visit our Help Center at www.carfaxonline.com.

Accident Indicator

CARFAX receives information about accidents in all 50 states, the District of Columbia and Canada.

Not every accident is reported to CARFAX. As details about the accident become available, those additional details are added to the CARFAX Vehicle History Report. CARFAX recommends that you have this vehicle inspected by a qualified mechanic.

- According to the National Safety Council, Injury Facts, 2021 edition, 5% of the 276 million registered vehicles in the U.S. were involved in an accident in 2019. Over 77% of these were considered minor or moderate.
- This CARFAX Vehicle History Report is based only on information supplied to CARFAX and available as of 4/22/26 at 11:48:29 AM (CDT). Other information about this vehicle, including problems, may not have been reported to CARFAX. Use this report as one important tool, along with a vehicle inspection and test drive, to make a better decision about your next used car.

Damage Indicator

Damage can be a result of many different types of events. Examples include contact with objects (other cars, trees, traffic signs, road debris, etc), vandalism, or weather-related events. Not every damage event is reported to CARFAX. As details about the damage event become available, those additional details are added to the CARFAX Vehicle History Report. CARFAX recommends that you have this vehicle inspected by a qualified mechanic.

- This CARFAX Vehicle History Report is based only on information supplied to CARFAX and available as of 4/22/26 at 11:48:29 AM (CDT). Other

added to the CARFAX Vehicle History Report. CARFAX recommends that you have this vehicle inspected by a qualified mechanic.

- This CARFAX Vehicle History Report is based only on information supplied to CARFAX and available as of 4/22/26 at 11:48:29 AM (CDT). Other information about this vehicle, including problems, may not have been reported to CARFAX. Use this report as one important tool, along with a vehicle inspection and test drive, to make a better decision about your next used car.

Damage Severity

Damage events result in one of the following severity levels:

- Minor: Generally, minor damage is cosmetic (including dents or scratches), may only require reconditioning, and typically does not compromise a vehicle's operation and/or safety.
- Moderate: Moderate damage may affect multiple components of the vehicle and may impair the vehicle's operation and/or safety.
- Severe: Severe damage usually affects multiple components of the vehicle and is likely to compromise the vehicle's operation and/or safety.

CARFAX recommends getting a pre-purchase inspection at a certified collision repair facility.

First Owner

When the first owner(s) obtains a title from a Department of Motor Vehicles as proof of ownership.

Manufacturer Recall

Automobile manufacturers issue recall notices to inform vehicle owners of a safety defect or failure to meet minimum federal safety or emissions standards. Manufacturer recalls are repaired at no cost to the customer.

New Owner Reported

When a vehicle is sold to a new owner, the Title must be transferred to the new owner(s) at a Department of Motor Vehicles.

Ownership History

CARFAX defines an owner as an individual or business that possesses and uses a vehicle. Not all title transactions represent changes in ownership. To provide estimated number of owners, CARFAX proprietary technology analyzes all the events in a vehicle history. Estimated ownership is available for vehicles manufactured after 1991 and titled solely in the US including Puerto Rico. Dealers sometimes opt to take ownership of a vehicle and are required to in the following states: Maine, Massachusetts, New Jersey, Ohio, Oklahoma, Pennsylvania and South Dakota. Please consider this as you review a vehicle's estimated ownership history.

Salvage Title

A Salvage Title is issued on a vehicle damaged to the extent that the cost of repairing the vehicle exceeds approximately 75% of its pre-damage value. This damage threshold may vary by state. Some states treat Junk titles the same as Salvage but the majority use this title to indicate that a vehicle is not road worthy and cannot be titled again in that state. The following eleven states also use Salvage titles to identify stolen vehicles - AZ, FL, GA, IL, MD, MN, NJ, NM, NY, OK and OR.

Title Issued

A state issues a title to provide a vehicle owner with proof of ownership. Each title has a unique number. Each title or registration record on a CARFAX report does not necessarily indicate a change in ownership. In Canada, a registration and bill of sale are used as proof of ownership.

Total Loss Vehicle

An insurance or fleet company declares a vehicle a total loss when a claim exceeds approximately 75% of its pre-damage value or if the vehicle is stolen and not recovered. This damage threshold varies by company. These companies typically take possession and obtain the title. Not all total loss vehicles result in a DMV-reported branded title. This may occur when an insurance company's definition of a total loss is different than the state DMV's definition for a branded title or when the owner of the vehicle is a self-insured company, like a fleet or rental company.

[Full Glossary](#)

Follow Us:



facebook.com/CARFAX



[@CARFAXinc](https://twitter.com/CARFAXinc)



[About CARFAX](#)

CARFAX DEPENDS ON ITS SOURCES FOR THE ACCURACY AND RELIABILITY OF ITS INFORMATION. THEREFORE, NO RESPONSIBILITY IS ASSUMED BY CARFAX OR ITS AGENTS FOR ERRORS OR OMISSIONS IN THIS REPORT. CARFAX FURTHER EXPRESSLY DISCLAIMS ALL WARRANTIES, EXPRESS OR IMPLIED, INCLUDING ANY IMPLIED WARRANTIES OF MERCHANTABILITY OR FITNESS FOR A PARTICULAR PURPOSE.

© 2026 CARFAX, Inc., part of S&P Global. All rights reserved.

4/22/26 11:48:29 AM (CDT)

I have reviewed and received a copy of the CARFAX Vehicle History Report for this 2016 BMW X5 vehicle (VIN: 5UXKT0C54G0S79081), which is based on information supplied to CARFAX and available as of 4/22/26 at 12:48 PM (EDT).

Customer Signature

Date

Dealer Signature

Date