

## CARFAX History-Based Value Report

**\$9,500**

CARFAX Retail Value

### History events affecting this vehicle's value

- Service History
- Personal Vehicle
- Damage Brand
- Open Recall

## CARFAX Vehicle History Report™

US \$44.99

### 2016 BMW X4 XDRIVE28I

VIN: 5UXXW3C56G0R22030  
 4 DOOR WAGON/SPORT UTILITY  
 2.0L I4 F DOHC 16V  
 GASOLINE  
 ALL WHEEL DRIVE

- Branded Titles: Rebuilt, Salvage >
- 14 Service history records >
- At least 1 open recall >
- 4 Previous owners >
- Types of owners: Personal lease, Personal >
- 135,490 Last reported odometer reading >

This CARFAX Vehicle History Report is based only on [information](#) supplied to CARFAX and available as of 3/3/26 at 9:37:32 AM (CST). Other information about this vehicle, including problems, may not have been reported to CARFAX. Use this report as one important tool, along with a vehicle inspection and test drive, to make a better decision about your next used car.

## CARFAX Accident / Damage History

Not all accidents / issues are reported to CARFAX

### Event 1

05/05/2020

#### Accident reported

- Involving left front impact with another motor vehicle
- It hit a parked motor vehicle
- Vehicle was not damaged

### Event 2

09/05/2025

#### Accident reported: minor damage ⓘ

- Involving right front impact
- Involving right side impact
- It hit a parked motor vehicle
- Airbags did not deploy

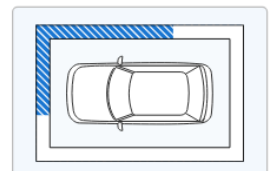
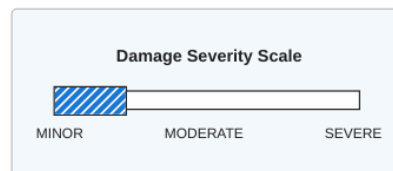

[View More Details >](#)

Event 3

01/02/2026

**Accident reported: minor damage with another motor vehicle**



- Vehicle functional
- Functional damage reported
- Airbags did not deploy

[View More Details >](#)

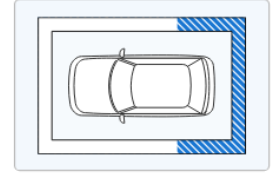
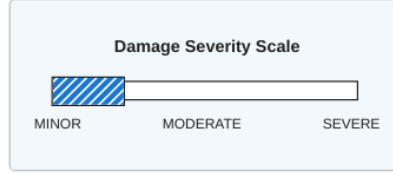

[Show More >](#)

<b>CARFAX</b> Additional History Not all accidents / issues are reported to CARFAX	Owners 1-2	Owner 3	Owner 4
<b>Total Loss</b> ⓘ Total Loss Reported: 02/18/2026.	✓ No Issues Reported	✓ No Issues Reported	<a href="#">Total Loss Reported</a>
<b>Structural Damage</b> ⓘ CARFAX recommends that you have this vehicle inspected by a collision repair specialist.	✓ No Issues Reported	✓ No Issues Reported	✓ No Issues Reported
<b>Airbag Deployment</b> ⓘ No airbag deployment reported to CARFAX.	✓ No Issues Reported	✓ No Issues Reported	✓ No Issues Reported
<b>Odometer Check</b> ⓘ No indication of an odometer rollback.	✓ No Issues Indicated	✓ No Issues Indicated	✓ No Issues Indicated
<b>Accident / Damage</b> ⓘ DMV title problems reported. Accidents reported: 05/05/2020, 09/05/2025, and 01/02/2026.	<a href="#">Accident Reported</a>	No New Issues Reported	<a href="#">Severe Damage</a>
<b>Manufacturer Recall</b> ⓘ At least 1 manufacturer recall requires service. Locate an authorized <a href="#">BMW dealer</a> near you to schedule an appointment.	<a href="#">Recall Reported</a>	No New Recalls Reported	<a href="#">Recall Reported</a>
<b>Basic Warranty</b> ⓘ Original manufacturer warranty likely voided by manufacturer.	✓ Warranty Active	✓ Warranty Active	<b>Warranty Voided</b>

<b>CARFAX</b> Title History	Owners 1-2	Owner 3	Owner 4
<b>Damage Brands</b> ⓘ Salvage   Junk   Rebuilt   Fire   Flood   Hail   Lemon	No Problem	No Problem	<b>Alert!</b> Problem Found
<b>Odometer Brands</b> ⓘ Not Actual Mileage   Exceeds Mechanical Limits	No Problem	No Problem	No Problem



**ALERT!** - Severe problems were reported by a state Department of Motor Vehicles (DMV). This vehicle does not qualify for the CARFAX Buyback Guarantee.

<b>CARFAX</b> Ownership History The number of owners is estimated	Owners 1-2	Owner 3	Owner 4
Year purchased	2016	2021	2023
Type of owner	<a href="#">See Details</a>	Personal	Personal
Estimated length of ownership	4 yrs. 11 mo.	1 yr. 8 mo.	2 yrs. 10 mo.

Estimated length of ownership	4 yrs. 11 mo.	1 yr. 8 mo.	2 yrs. 10 mo.
Owned in the following states/provinces	<a href="#">See Details</a>	Indiana, Illinois	Illinois
Estimated miles driven per year	<a href="#">See Details</a>	---	12,158/yr
Last reported odometer reading	69,055	94,026	135,490

**CARFAX** Detailed History









[Glossary](#)

**Owner 1** Personal Lease Vehicle  
Purchased: 2016

Date	Mileage	Source	Comments
01/06/2016	10	New Jersey Motor Vehicle Dept. Woodcliff Lake, NJ Title #RV20160060716	<b>Title issued or updated</b> -Registration issued or renewed -First owner reported -Titled or registered as personal lease vehicle -Vehicle color noted as Gray
05/19/2016		BMW of North America, LLC	<b>Manufacturer Safety recall issued</b> -NHTSA #16V-333 -Recall #16V-333:223 ISOFIX BRACKET -Status: Remedy Available  Need more information about this recall? Find an authorized <a href="#">BMW dealer</a> , email <a href="mailto:CustomerRelations@bmwusa.com">CustomerRelations@bmwusa.com</a> , or call 1-800-525-7417  <a href="#">+ Learn more about this recall</a>
08/03/2016	7,168	BMW of Schererville Schererville, IN 219-864-7333 <a href="http://bmwinschererville.com">bmwinschererville.com</a> <b>2,157</b> Customer Favorites	<b>Vehicle serviced</b> -Pre-delivery inspection completed -Maintenance inspection completed -Engine checked -Oil and filter changed
08/07/2016		Dealer Inventory	<b>Vehicle offered for sale</b>
08/15/2016	7,180	BMW Certified Dealer Schererville, IN	<b>Sold as a BMW Certified Pre-Owned Vehicle</b>
08/15/2016		Illinois Motor Vehicle Dept.	<b>Vehicle purchase reported</b>
08/30/2016		Illinois Motor Vehicle Dept. Chicago Heights, IL	<b>Registration issued or renewed</b> -Correction to record

**Owner 2** Personal Vehicle  
16,017 mi/yr  
Purchased: 2016

Date	Mileage	Source	Comments
10/06/2016		Illinois Motor Vehicle Dept. Chicago Heights, IL Title #162808660180	<b>Title issued or updated</b> -New owner reported -Loan or lien reported
06/07/2017		Illinois Motor Vehicle Dept. Chicago Heights, IL	<b>Registration issued or renewed</b>
06/21/2017	12,772	BMW of Schererville Schererville, IN	<b>Vehicle serviced</b> -Electrical system checked

06/21/2017	12,772	BMW of Schererville Schererville, IN 219-864-7333 bmwinschererville.com ♥ 2,157 Customer Favorites		<b>Vehicle serviced</b> -Electrical system checked -Engine checked -Oil and filter changed
01/29/2018	21,343	BMW of Schererville Schererville, IN 219-864-7333 bmwinschererville.com ♥ 2,157 Customer Favorites		<b>Vehicle serviced</b> -Brakes checked -Engine checked -Oil and filter changed
06/04/2018	27,269	BMW of Schererville Schererville, IN 219-864-7333 bmwinschererville.com ♥ 2,157 Customer Favorites		<b>Vehicle serviced</b> -Maintenance inspection completed -Engine checked -Oil and filter changed -Tire condition and pressure checked
06/13/2018		Illinois Motor Vehicle Dept. Chicago Heights, IL		<b>Registration issued or renewed</b>
11/12/2018	34,806	BMW of Schererville Schererville, IN 219-864-7333 bmwinschererville.com ♥ 2,157 Customer Favorites		<b>Vehicle serviced</b> -Air filter replaced -Brake fluid flushed/changed -Engine checked -Front wiper blades/refills replaced -Lights checked -Oil and filter changed -Wiper(s) replaced
04/15/2019	42,126	BMW of Schererville Schererville, IN 219-864-7333 bmwinschererville.com ♥ 2,157 Customer Favorites		<b>Vehicle serviced</b> -Alignment performed -Cabin air filter replaced/cleaned -Engine checked -Oil and filter changed -Spark plug(s) replaced
06/12/2019		Illinois Motor Vehicle Dept. Chicago Heights, IL		<b>Registration issued or renewed</b> -Correction to record
09/30/2019	50,101	BMW of Schererville Schererville, IN 219-864-7333 bmwinschererville.com ♥ 2,157 Customer Favorites		<b>Vehicle serviced</b> -Maintenance inspection completed -Recommended maintenance performed
03/31/2020	58,561	Tire Barn Warehouse Schererville, IN 219-322-1712 tirebarn.com ♥ 1 Customer Favorite		<b>Vehicle serviced</b> -Maintenance inspection completed -Tire condition and pressure checked -Tire pressure monitoring system checked -Tire(s) replaced
05/05/2020		Damage Report		<b>Accident reported</b> -Involving left front impact with another motor vehicle -It hit a parked motor vehicle -Vehicle was not damaged
09/28/2020	65,000	Illinois Inspection Station Harvey, IL		<b>Passed emissions inspection</b>
12/22/2020	68,942	BMW of Schererville Schererville, IN ♥ 2,157 Customer Favorites		<b>Vehicle offered for sale</b>
12/31/2020		BMW of Schererville Schererville, IN 219-864-7333 bmwinschererville.com ♥ 2,157 Customer Favorites		<b>Vehicle serviced</b> -Pre-delivery inspection completed -Brakes checked -Brake fluid flushed/changed



Looks like this dealer serviced the car in order to prepare it for sale.



Looks like this dealer serviced the car in order to prepare it for sale. That's a good thing!

01/04/2021	68,946	BMW of Schererville Schererville, IN 219-864-7333 bmwinschererville.com ❤️ 2,157 Customer Favorites	Vehicle sold
01/04/2021		Indiana Motor Vehicle Dept.	Vehicle purchase reported
01/04/2021	69,055	Service Plan Co. Elkhart, IN	Service contract issued

<b>Owner 3</b> Purchased: 2021				Personal Vehicle
Date	Mileage	Source	Comments	
03/09/2021		Indiana Motor Vehicle Dept. Elkhart, IN Title #21798064000450	<b>Title issued or updated</b> -Registration issued or renewed -New owner reported -Loan or lien reported -Vehicle color noted as Black	
05/20/2022		Walmart Auto Care Center Elkhart, IN 574-266-7463 <a href="https://www.walmart.com">https://www.walmart.com</a>		<b>Vehicle serviced</b> -Tire(s) balanced -Tire(s) replaced
07/29/2022		Indiana Motor Vehicle Dept. Granger, IN	<b>Registration issued or renewed</b> -Registration updated when owner moved the vehicle to a new location -Vehicle color noted as Black	
11/30/2022		Online Listing	<b>Vehicle offered for sale</b>	
12/06/2022	93,876	Adam Auto Group Crestwood, IL 708-972-7914 adamautogroupinc.com/	<b>Vehicle offered for sale</b>	
12/10/2022	94,026	Online Listing	<b>Vehicle offered for sale</b>	
01/11/2023		Online Listing	<b>Vehicle offered for sale</b>	
03/03/2023		Illinois Motor Vehicle Dept.	<b>Vehicle purchase reported</b>	
03/20/2023		Illinois Motor Vehicle Dept. Riverdale, IL	<b>Registration issued or renewed</b>	

<b>Owner 4</b> Purchased: 2023				Personal Vehicle 12,158 mi/yr
Date	Mileage	Source	Comments	
03/29/2023		Illinois Motor Vehicle Dept. Riverdale, IL Title #230886981380	<b>Title issued or updated</b> -New owner reported -Loan or lien reported -Vehicle color noted as Gray	
11/21/2023	108,175	BMW of Schererville Schererville, IN 219-864-7333 bmwinschererville.com		<b>Vehicle serviced</b> -Oil and filter changed

Schererville, IN  
219-864-7333  
bmwinschererville.com  
♥ 2,157 Customer Favorites

04/04/2024 115,000 Illinois Inspection Station Harvey, IL **Passed emissions inspection**

04/04/2024 Illinois Motor Vehicle Dept. Riverdale, IL **Registration issued or renewed**

04/16/2024 116,301 BMW of Schererville Schererville, IN 219-864-7333 bmwinschererville.com ♥ 2,157 Customer Favorites  **Vehicle serviced**  
- Drive belt(s) replaced  
- Internal transmission repaired  
- Serpentine belt replaced  
- Transmission serviced

05/02/2024 116,935 BMW of Schererville Schererville, IN 219-864-7333 bmwinschererville.com ♥ 2,157 Customer Favorites  **Vehicle serviced**  
- Electrical system checked

08/13/2024 BMW of North America, LLC **Manufacturer Safety recall issued**  
- NHTSA #24V-608  
- Recall #24V-608:474 ENGINE COOLANT PUMP  
- Status: Remedy Available  
  
Need more information about this recall? Find an authorized [BMW dealer](#), email [CustomerRelations@bmwusa.com](mailto:CustomerRelations@bmwusa.com), or call 1-800-525-7417  
  
[+ Learn more about this recall](#)

03/25/2025 Illinois Motor Vehicle Dept. Riverdale, IL **Registration issued or renewed**

09/05/2025 Damage Report  **Accident reported: minor damage** ⓘ  
- Involving right front impact  
- Involving right side impact  
- It hit a parked motor vehicle  
- Damage to front  
- Airbags did not deploy

**CARFAX HAS THE MOST ACCIDENT & DAMAGE INFORMATION**

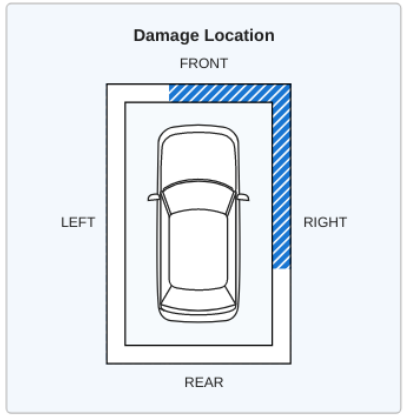
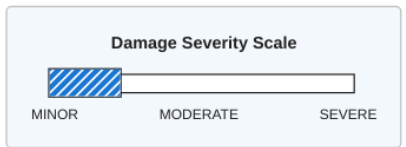

12/10/2025 134,381 BMW of Schererville Schererville, IN 219-864-7333 bmwinschererville.com ♥ 2,157 Customer Favorites  **Vehicle serviced**  
- Drivability/performance checked  
- Engine oil pressure checked

12/24/2025 135,000 Illinois Inspection Station **Passed emissions inspection**

12/24/2025

135,000

Illinois  
Inspection Station  
Harvey, IL

Passed emissions inspection

01/02/2026

Damage Report



**Accident reported: minor damage with another motor vehicle**

- Damage to left rear
- Damage to rear
- Damage to right rear
- Vehicle functional
- Functional damage reported
- Airbags did not deploy

**CARFAX HAS THE MOST ACCIDENT & DAMAGE INFORMATION**

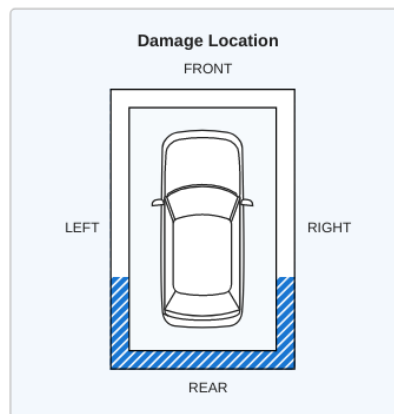
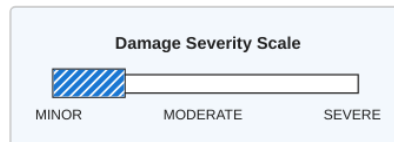

02/05/2026

Illinois  
Motor Vehicle Dept.

**Vehicle purchase reported**

02/18/2026

Damage Report



**TOTAL LOSS VEHICLE**



There are many reasons an insurance company will declare a vehicle a total loss. Have this vehicle inspected by a qualified technician before you buy. [Learn More](#)

02/18/2026

Illinois  
Motor Vehicle Dept.

**Title or registration issued to insurance company**

02/18/2026

135,490

Illinois  
Motor Vehicle Dept.  
Westchester, IL  
Title #260496986570



**SALVAGE TITLE/CERTIFICATE ISSUED**

- REBUILT TITLE ISSUED
- Loan or lien reported
- Vehicle color noted as Gray



Avoid financial headaches. Make sure the loan has been paid off if you're buying from a private seller. [Learn More](#)

Have Questions? Consumers, please visit our Help Center at [www.carfax.com](http://www.carfax.com). Dealers or Subscribers, please visit our Help Center at [www.carfaxonline.com](http://www.carfaxonline.com).

**Accident Indicator**

CARFAX receives information about accidents in all 50 states, the District of Columbia and Canada.

Not every accident is reported to CARFAX. As details about the accident become available, those additional details are added to the CARFAX Vehicle History Report. CARFAX recommends that you have this vehicle inspected by a qualified mechanic.

- According to the National Safety Council, Injury Facts, 2021 edition, 5% of the 276 million registered vehicles in the U.S. were involved in an accident in 2019. Over 77% of these were considered minor or moderate.
- This CARFAX Vehicle History Report is based only on information supplied to CARFAX and available as of 3/3/26 at 9:37:32 AM (CST). Other information about this vehicle, including problems, may not have been reported to CARFAX. Use this report as one important tool, along with a vehicle inspection and test drive, to make a better decision about your next used car.

about this vehicle, including problems, may not have been reported to CARFAX. Use this report as one important tool, along with a vehicle inspection and test drive, to make a better decision about your next used car.

### Damage Indicator

Damage can be a result of many different types of events. Examples include contact with objects (other cars, trees, traffic signs, road debris, etc), vandalism, or weather-related events. Not every damage event is reported to CARFAX. As details about the damage event become available, those additional details are added to the CARFAX Vehicle History Report. CARFAX recommends that you have this vehicle inspected by a qualified mechanic.

- This CARFAX Vehicle History Report is based only on information supplied to CARFAX and available as of 3/3/26 at 9:37:32 AM (CST). Other information about this vehicle, including problems, may not have been reported to CARFAX. Use this report as one important tool, along with a vehicle inspection and test drive, to make a better decision about your next used car.

### Damage Severity

Damage events result in one of the following severity levels:

- Minor: Generally, minor damage is cosmetic (including dents or scratches), may only require reconditioning, and typically does not compromise a vehicle's operation and/or safety.
- Moderate: Moderate damage may affect multiple components of the vehicle and may impair the vehicle's operation and/or safety.
- Severe: Severe damage usually affects multiple components of the vehicle and is likely to compromise the vehicle's operation and/or safety.

CARFAX recommends getting a pre-purchase inspection at a certified collision repair facility.

### First Owner

When the first owner(s) obtains a title from a Department of Motor Vehicles as proof of ownership.

### Manufacturer Recall

Automobile manufacturers issue recall notices to inform vehicle owners of a safety defect or failure to meet minimum federal safety or emissions standards. Manufacturer recalls are repaired at no cost to the customer.

### New Owner Reported

When a vehicle is sold to a new owner, the Title must be transferred to the new owner(s) at a Department of Motor Vehicles.

### Ownership History

CARFAX defines an owner as an individual or business that possesses and uses a vehicle. Not all title transactions represent changes in ownership. To provide estimated number of owners, CARFAX proprietary technology analyzes all the events in a vehicle history. Estimated ownership is available for vehicles manufactured after 1991 and titled solely in the US including Puerto Rico. Dealers sometimes opt to take ownership of a vehicle and are required to in the following states: Maine, Massachusetts, New Jersey, Ohio, Oklahoma, Pennsylvania and South Dakota. Please consider this as you review a vehicle's estimated ownership history.

### Rebuilt/Reconstructed Title

A Rebuilt/Reconstructed vehicle is a salvage vehicle that has been repaired and restored to operation. These vehicles are often severely damaged before they are rebuilt and refurbished parts are typically used during reconstruction. In most states, an inspection of the vehicle is required before the vehicle is allowed to return to the road.

### Salvage Title

A Salvage Title is issued on a vehicle damaged to the extent that the cost of repairing the vehicle exceeds approximately 75% of its pre-damage value. This damage threshold may vary by state. Some states treat Junk titles the same as Salvage but the majority use this title to indicate that a vehicle is not road worthy and cannot be titled again in that state. The following eleven states also use Salvage titles to identify stolen vehicles - AZ, FL, GA, IL, MD, MN, NJ, NM, NY, OK and OR.

### Title Issued

A state issues a title to provide a vehicle owner with proof of ownership. Each title has a unique number. Each title or registration record on a CARFAX report does not necessarily indicate a change in ownership. In Canada, a registration and bill of sale are used as proof of ownership.

### Total Loss Vehicle

An insurance or fleet company declares a vehicle a total loss when a claim exceeds approximately 75% of its pre-damage value or if the vehicle is stolen and not recovered. This damage threshold varies by company. These companies typically take possession and obtain the title. Not all total loss vehicles result in a DMV-reported branded title. This may occur when an insurance company's definition of a total loss is different than the state DMV's definition for a branded title or when the owner of the vehicle is a self-insured company, like a fleet or rental company.

Follow Us:



[facebook.com/CARFAX](https://facebook.com/CARFAX)



[@CARFAXinc](https://twitter.com/CARFAXinc)



[About CARFAX](#)

CARFAX DEPENDS ON ITS SOURCES FOR THE ACCURACY AND RELIABILITY OF ITS INFORMATION. THEREFORE, NO RESPONSIBILITY IS ASSUMED BY CARFAX OR ITS AGENTS FOR ERRORS OR OMISSIONS IN THIS REPORT. CARFAX FURTHER EXPRESSLY DISCLAIMS ALL WARRANTIES, EXPRESS OR IMPLIED, INCLUDING ANY IMPLIED WARRANTIES OF MERCHANTABILITY OR FITNESS FOR A PARTICULAR PURPOSE.

© 2026 CARFAX, Inc., part of S&P Global. All rights reserved.

3/3/26 9:37:32 AM (CST)

I have reviewed and received a copy of the CARFAX Vehicle History Report for this 2016 BMW X4 vehicle (VIN: 5UXXW3C56G0R22030), which is based on information supplied to CARFAX and available as of 3/3/26 at 10:37 AM (EST).

Customer Signature

Date

Dealer Signature

Date

