

CARFAX History-Based Value Report

[Hide](#)

\$10,630

CARFAX Retail Value

Retail
 Wholesale

History events affecting this vehicle's value

- Personal Vehicle
- Salvage Brand

This CARFAX Vehicle History Report is based only on [information](#) supplied to CARFAX and available as of 4/4/25 at 8:37:50 AM (CDT). Other information about this vehicle, including problems, may not have been reported to CARFAX. Use this report as one important tool, along with a vehicle inspection and test drive, to make a better decision about your next used car.

CARFAX Accident / Damage History

Not all accidents / issues are reported to CARFAX

Event 1

10/31/2022

Accident reported

- Vehicle involved in a rear-end collision with another motor vehicle
- Functional damage reported
- Airbags did not deploy

[View More Details >](#)

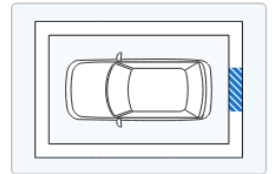

Event 2

01/20/2025

Accident reported

- Vehicle involved in a rear-end collision
- It hit an object
- Functional damage reported
- Vehicle hit while parked

[View More Details >](#)

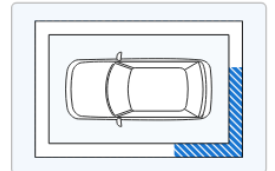

Event 3

03/20/2025

TOTAL LOSS VEHICLE

[View More Details >](#)

CARFAX Additional History

Not all accidents / issues are reported to CARFAX

Owner 1

Owner 2

Total Loss ⓘ

Total Loss Reported: 03/20/2025.

No Issues Reported

[Total Loss Reported](#)

Structural Damage ⓘ

CARFAX recommends that you have this vehicle inspected by a collision repair specialist.

No Issues Reported

No Issues Reported

Airbag Deployment ⓘ

No Issues Reported

No Issues Reported

Airbag Deployment ⓘ No airbag deployment reported to CARFAX.	✔ No Issues Reported	✔ No Issues Reported
Odometer Check ⓘ No indication of an odometer rollback.	✔ No Issues Indicated	✔ No Issues Indicated
Accident / Damage ⓘ DMV title problems reported. Accidents reported: 10/31/2022 and 01/20/2025.	✔ No Issues Reported	Severe Damage
Manufacturer Recall ⓘ Check with an authorized Tesla dealer for any open recalls.	Ask Your Dealer	Ask Your Dealer
Basic Warranty ⓘ Original manufacturer warranty likely voided by manufacturer.	✔ Warranty Active	Warranty Voided

CARFAX Title History	Owner 1	Owner 2
Damage Brands ⓘ Salvage Junk Rebuilt Fire Flood Hail Lemon	No Problem	Alert! Problem Found
Odometer Brands ⓘ Not Actual Mileage Exceeds Mechanical Limits	No Problem	No Problem
 ALERT! - Severe problems were reported by a state Department of Motor Vehicles (DMV). This vehicle does not qualify for the CARFAX Buyback Guarantee.		

CARFAX Ownership History	Owner 1	Owner 2
The number of owners is estimated		
Year purchased	2018	2022
Type of owner	Personal lease	Personal
Estimated length of ownership	3 yrs. 1 mo.	3 yrs. 1 mo.
Owned in the following states/provinces	California, Virginia	Maryland
Estimated miles driven per year	20,327/yr	24,154/yr
Last reported odometer reading	63,819	90,160



CARFAX Detailed History [Glossary](#)

 Owner 1 Purchased: 2018		Personal Lease Vehicle 20,327 mi/yr	
Date	Mileage	Source	Comments
11/27/2018	3	Virginia Inspection Station	Passed safety inspection
12/01/2018	50	Virginia Motor Vehicle Dept.	Vehicle purchase reported
12/01/2018		California Motor Vehicle Dept.	Titled or registered as personal lease vehicle
12/28/2018		Virginia	Title issued or updated

12/28/2018		Virginia Motor Vehicle Dept. Palo Alto, CA		Title issued or updated - Title or registration issued - First owner reported
08/20/2019		Virginia Motor Vehicle Dept. Palo Alto, CA		Registration issued or renewed
11/18/2019	17,332	Virginia Inspection Station		Passed safety inspection
11/20/2019		Virginia Motor Vehicle Dept. Palo Alto, CA		Registration issued or renewed
01/12/2021	44,014	Virginia Inspection Station		Passed safety inspection
01/19/2022	63,818	Precision Tune Auto Care Owings Mills, MD 410-356-9700 precisiontune.com ★ 4.8 / 5.0 132 Verified Reviews ❤️ 781 Customer Favorites		Vehicle serviced - Emissions or safety inspection performed
01/19/2022	63,819	Maryland Inspection Station Owings Mills, MD		Passed safety inspection

 **Owner 2**
Purchased: 2022

Personal Vehicle
24,154 mi/yr





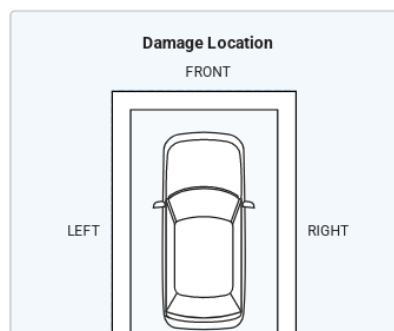

Date	Mileage	Source		Comments
01/26/2022	63,822	Maryland Motor Vehicle Dept. Hagerstown, MD Title #55677895		Registration issued or renewed - Title or registration issued - New owner reported - Loan or lien reported
03/29/2022		Maryland Motor Vehicle Dept. Hagerstown, MD Title #55677895		Title or registration issued - Loan or lien reported
04/29/2022	68,433	Hagerstown Ford Hagerstown, MD 301-733-3673 hagerstownford.com ★ 4.5 / 5.0 250 Verified Reviews ❤️ 144 Customer Favorites		Vehicle serviced
10/31/2022		Damage Report		Accident reported - Vehicle involved in a rear-end collision with another motor vehicle - Damage to rear - Functional damage reported - Airbags did not deploy



**CARFAX HAS THE MOST
ACCIDENT & DAMAGE
INFORMATION**

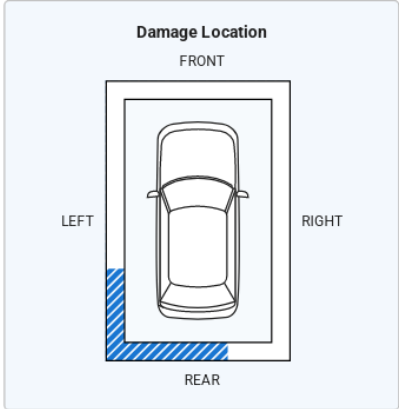



02/28/2023	90,160	Hagerstown Ford Hagerstown, MD 301-733-3673 hagerstownford.com ★ 4.5 / 5.0 250 Verified Reviews ♥ 144 Customer Favorites	 Vehicle serviced - Glass checked
12/21/2023		Maryland Motor Vehicle Dept. Hagerstown, MD Title #55677895	Registration issued or renewed - Loan or lien reported
01/20/2025		Damage Report	 Accident reported - Vehicle involved in a rear-end collision - It hit an object - Damage to rear - Damage to left rear - Functional damage reported - Vehicle hit while parked
<p>CARFAX HAS THE MOST ACCIDENT & DAMAGE INFORMATION</p>			
03/20/2025		Damage Report	 TOTAL LOSS VEHICLE
			<div style="border: 1px solid blue; padding: 5px;"> <p>There are many reasons an insurance company will declare a vehicle a total loss. Have this vehicle inspected by a qualified technician before you buy. Learn More</p> </div>
03/20/2025		Maryland Motor Vehicle Dept.	Title or registration issued to insurance company
03/20/2025		Maryland Motor Vehicle Dept. Curtis Bay, MD Title #60732405	 SALVAGE TITLE/CERTIFICATE ISSUED

Have Questions? Consumers, please visit our Help Center at www.carfax.com. Dealers or Subscribers, please visit our Help Center at www.carfaxonline.com.

Accident Indicator

CARFAX receives information about accidents in all 50 states, the District of Columbia and Canada.

Not every accident is reported to CARFAX. As details about the accident become available, those additional details are added to the CARFAX Vehicle History Report. CARFAX recommends that you have this vehicle inspected by a qualified mechanic.

CARFAX recommends that you have this vehicle inspected by a qualified mechanic.

- According to the National Safety Council, Injury Facts, 2021 edition, 5% of the 276 million registered vehicles in the U.S. were involved in an accident in 2019. Over 77% of these were considered minor or moderate.
- This CARFAX Vehicle History Report is based only on information supplied to CARFAX and available as of 4/4/25 at 8:37:50 AM (CDT). Other information about this vehicle, including problems, may not have been reported to CARFAX. Use this report as one important tool, along with a vehicle inspection and test drive, to make a better decision about your next used car.

Damage Indicator

Damage can be a result of many different types of events. Examples include contact with objects (other cars, trees, traffic signs, road debris, etc), vandalism, or weather-related events. Not every damage event is reported to CARFAX. As details about the damage event become available, those additional details are added to the CARFAX Vehicle History Report. CARFAX recommends that you have this vehicle inspected by a qualified mechanic.

- This CARFAX Vehicle History Report is based only on information supplied to CARFAX and available as of 4/4/25 at 8:37:50 AM (CDT). Other information about this vehicle, including problems, may not have been reported to CARFAX. Use this report as one important tool, along with a vehicle inspection and test drive, to make a better decision about your next used car.

First Owner

When the first owner(s) obtains a title from a Department of Motor Vehicles as proof of ownership.

New Owner Reported

When a vehicle is sold to a new owner, the Title must be transferred to the new owner(s) at a Department of Motor Vehicles.

Ownership History

CARFAX defines an owner as an individual or business that possesses and uses a vehicle. Not all title transactions represent changes in ownership. To provide estimated number of owners, CARFAX proprietary technology analyzes all the events in a vehicle history. Estimated ownership is available for vehicles manufactured after 1991 and titled solely in the US including Puerto Rico. Dealers sometimes opt to take ownership of a vehicle and are required to in the following states: Maine, Massachusetts, New Jersey, Ohio, Oklahoma, Pennsylvania and South Dakota. Please consider this as you review a vehicle's estimated ownership history.

Salvage Title



A Salvage Title is issued on a vehicle damaged to the extent that the cost of repairing the vehicle exceeds approximately 75% of its pre-damage value. This damage threshold may vary by state. Some states treat Junk titles the same as Salvage but the majority use this title to indicate that a vehicle is not road worthy and cannot be titled again in that state. The following eleven states also use Salvage titles to identify stolen vehicles - AZ, FL, GA, IL, MD, MN, NJ, NM, NY, OK and OR.

Title Issued

A state issues a title to provide a vehicle owner with proof of ownership. Each title has a unique number. Each title or registration record on a CARFAX report does not necessarily indicate a change in ownership. In Canada, a registration and bill of sale are used as proof of ownership.

Total Loss Vehicle

An insurance or fleet company declares a vehicle a total loss when a claim exceeds approximately 75% of its pre-damage value or if the vehicle is stolen and not recovered. This damage threshold varies by company. These companies typically take possession and obtain the title. Not all total loss vehicles result in a DMV-reported branded title. This may occur when an insurance company's definition of a total loss is different than the state DMV's definition for a branded title or when the owner of the vehicle is a self-insured company, like a fleet or rental company.

Follow Us:  facebook.com/CARFAX  [@CARFAXinc](https://twitter.com/CARFAXinc)  [About CARFAX](#)

CARFAX DEPENDS ON ITS SOURCES FOR THE ACCURACY AND RELIABILITY OF ITS INFORMATION. THEREFORE, NO RESPONSIBILITY IS ASSUMED BY CARFAX OR ITS AGENTS FOR ERRORS OR OMISSIONS IN THIS REPORT. CARFAX FURTHER EXPRESSLY DISCLAIMS ALL WARRANTIES, EXPRESS OR IMPLIED, INCLUDING ANY IMPLIED WARRANTIES OF MERCHANTABILITY OR FITNESS FOR A PARTICULAR PURPOSE.

© 2025 CARFAX, Inc., part of S&P Global. All rights reserved.
4/4/25 8:37:50 AM (CDT)

I have reviewed and received a copy of the CARFAX Vehicle History Report for this 2018 TESLA MODEL S vehicle (VIN: 5YJSA1E29JF291736), which is based on information supplied to CARFAX and available as of 4/4/25 at 9:37 AM (EDT).

Customer Signature

Date

Dealer Signature

Date

 History-Based Value Report

Hide

\$10,630

CARFAX Retail Value

History events affecting this vehicle's value

  Personal Vehicle



Vehicle History Report™

US \$44.99

2018 TESLA MODEL S 75D

VIN: 5YJSA1E29JF291736
 HATCHBACK 4 DR
 X 0V
 ELECTRIC
 ALL WHEEL DRIVE

Branded Title: Salvage >

3 Service history records >

2 Previous owners >

Types of owners: Personal lease, Personal >

Last owned in Maryland >

90,160 Last reported odometer reading >

CARFAX HAS THE MOST ACCIDENT & DAMAGE INFORMATION



This CARFAX Vehicle History Report is based only on [information](#) supplied to CARFAX and available as of 4/4/25 at 8:37:50 AM (CDT). Other information about this vehicle, including problems, may not have been reported to CARFAX. Use this report as one important tool, along with a vehicle inspection and test drive, to make a better decision about your next used car.



Accident / Damage History

Not all accidents / issues are reported to CARFAX

Event 1

10/31/2022

Accident reported

- Vehicle involved in a rear-end collision with another motor vehicle
- Functional damage reported
- Airbags did not deploy

[View More Details >](#)

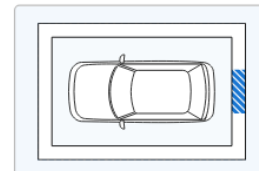

Event 2

01/20/2025

Accident reported

- Vehicle involved in a rear-end collision
- It hit an object
- Functional damage reported
- Vehicle hit while parked

[View More Details >](#)

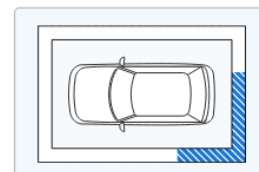

Event 3

03/20/2025

TOTAL LOSS VEHICLE

[View More Details >](#)



Additional History

Not all accidents / issues are reported to CARFAX

Owner 1

Owner 2

Total Loss

No Issues Reported

Total Loss Reported

Total Loss ⓘ Total Loss Reported: 03/20/2025.	<input checked="" type="checkbox"/> No Issues Reported	Total Loss Reported
Structural Damage ⓘ CARFAX recommends that you have this vehicle inspected by a collision repair specialist.	<input checked="" type="checkbox"/> No Issues Reported	<input checked="" type="checkbox"/> No Issues Reported
Airbag Deployment ⓘ No airbag deployment reported to CARFAX.	<input checked="" type="checkbox"/> No Issues Reported	<input checked="" type="checkbox"/> No Issues Reported
Odometer Check ⓘ No indication of an odometer rollback.	<input checked="" type="checkbox"/> No Issues Indicated	<input checked="" type="checkbox"/> No Issues Indicated
Accident / Damage ⓘ DMV title problems reported. Accidents reported: 10/31/2022 and 01/20/2025.	<input checked="" type="checkbox"/> No Issues Reported	Severe Damage
Manufacturer Recall ⓘ Check with an authorized Tesla dealer for any open recalls.	Ask Your Dealer	Ask Your Dealer
Basic Warranty ⓘ Original manufacturer warranty likely voided by manufacturer.	<input checked="" type="checkbox"/> Warranty Active	Warranty Voided

Title History	Owner 1	Owner 2
Damage Brands ⓘ Salvage Junk Rebuilt Fire Flood Hail Lemon	No Problem	Alert! Problem Found
Odometer Brands ⓘ Not Actual Mileage Exceeds Mechanical Limits	No Problem	No Problem
ALERT! - Severe problems were reported by a state Department of Motor Vehicles (DMV). This vehicle does not qualify for the CARFAX Buyback Guarantee.		



Ownership History The number of owners is estimated	Owner 1	Owner 2
Year purchased	2018	2022
Type of owner	Personal lease	Personal
Estimated length of ownership	3 yrs. 1 mo.	3 yrs. 1 mo.
Owned in the following states/provinces	California, Virginia	Maryland
Estimated miles driven per year	20,327/yr	24,154/yr
Last reported odometer reading	63,819	90,160

Detailed History [Glossary](#)

Owner 1 Purchased: 2018	Personal Lease Vehicle 20,327 mi/yr		
Date	Mileage	Source	Comments
11/27/2018	3	Virginia Inspection Station	Passed safety inspection

12/01/2018	50	Virginia Motor Vehicle Dept.		Vehicle purchase reported
12/01/2018		California Motor Vehicle Dept.		Titled or registered as personal lease vehicle
12/28/2018		Virginia Motor Vehicle Dept. Palo Alto, CA		Title issued or updated - Title or registration issued - First owner reported
08/20/2019		Virginia Motor Vehicle Dept. Palo Alto, CA		Registration issued or renewed
11/18/2019	17,332	Virginia Inspection Station		Passed safety inspection
11/20/2019		Virginia Motor Vehicle Dept. Palo Alto, CA		Registration issued or renewed
01/12/2021	44,014	Virginia Inspection Station		Passed safety inspection
01/19/2022	63,818	Precision Tune Auto Care Owings Mills, MD 410-356-9700 precisiontune.com ★ 4.8 / 5.0 132 Verified Reviews ✓ ❤️ 781 Customer Favorites		Vehicle serviced - Emissions or safety inspection performed
01/19/2022	63,819	Maryland Inspection Station Owings Mills, MD		Passed safety inspection

 Owner 2 Purchased: 2022	Personal Vehicle 24,154 mi/yr
--	----------------------------------

Date	Mileage	Source		Comments
01/26/2022	63,822	Maryland Motor Vehicle Dept. Hagerstown, MD Title #55677895		Registration issued or renewed - Title or registration issued - New owner reported - Loan or lien reported
03/29/2022		Maryland Motor Vehicle Dept. Hagerstown, MD Title #55677895		Title or registration issued - Loan or lien reported
04/29/2022	68,433	Hagerstown Ford Hagerstown, MD 301-733-3673 hagerstownford.com ★ 4.5 / 5.0 250 Verified Reviews ✓ ❤️ 144 Customer Favorites		Vehicle serviced
10/31/2022		Damage Report		Accident reported - Vehicle involved in a rear-end collision with another motor vehicle - Damage to rear - Functional damage reported - Airbags did not deploy



Damage Location

FRONT

CARFAX HAS THE MOST ACCIDENT & DAMAGE INFORMATION



02/28/2023

90,160

Hagerstown Ford
Hagerstown, MD
301-733-3673
hagerstownford.com



Vehicle serviced
- Glass checked

★ 4.5 / 5.0 [250 Verified Reviews](#) ✓
♥ 144 Customer Favorites

12/21/2023

Maryland
Motor Vehicle Dept.
Hagerstown, MD
Title #55677895

Registration issued or renewed
- Loan or lien reported

01/20/2025

Damage Report



Accident reported
- Vehicle involved in a rear-end collision
- It hit an object
- Damage to rear
- Damage to left rear
- Functional damage reported
- Vehicle hit while parked

CARFAX HAS THE MOST ACCIDENT & DAMAGE INFORMATION

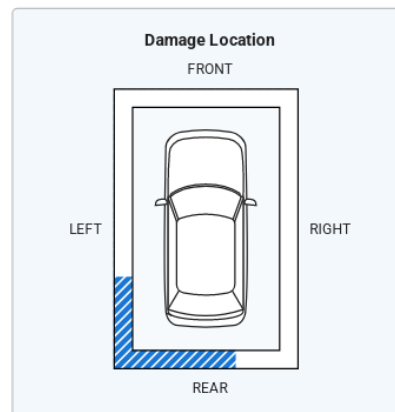

03/20/2025

Damage Report



TOTAL LOSS VEHICLE



There are many reasons an insurance company will declare a vehicle a total loss. Have this vehicle inspected by a qualified technician before you buy. [Learn More](#)

03/20/2025

Maryland
Motor Vehicle Dept.

Title or registration issued to insurance company

03/20/2025

Maryland
Motor Vehicle Dept.
Curtis Bay, MD
Title #60732405



SALVAGE TITLE/CERTIFICATE ISSUED

Accident Indicator

CARFAX receives information about accidents in all 50 states, the District of Columbia and Canada.

Not every accident is reported to CARFAX. As details about the accident become available, those additional details are added to the CARFAX Vehicle History Report. CARFAX recommends that you have this vehicle inspected by a qualified mechanic.

- According to the National Safety Council, Injury Facts, 2021 edition, 5% of the 276 million registered vehicles in the U.S. were involved in an accident in 2019. Over 77% of these were considered minor or moderate.
- This CARFAX Vehicle History Report is based only on information supplied to CARFAX and available as of 4/4/25 at 8:37:50 AM (CDT). Other information about this vehicle, including problems, may not have been reported to CARFAX. Use this report as one important tool, along with a vehicle inspection and test drive, to make a better decision about your next used car.

Damage Indicator

Damage can be a result of many different types of events. Examples include contact with objects (other cars, trees, traffic signs, road debris, etc), vandalism, or weather-related events. Not every damage event is reported to CARFAX. As details about the damage event become available, those additional details are added to the CARFAX Vehicle History Report. CARFAX recommends that you have this vehicle inspected by a qualified mechanic.

- This CARFAX Vehicle History Report is based only on information supplied to CARFAX and available as of 4/4/25 at 8:37:50 AM (CDT). Other information about this vehicle, including problems, may not have been reported to CARFAX. Use this report as one important tool, along with a vehicle inspection and test drive, to make a better decision about your next used car.

First Owner

When the first owner(s) obtains a title from a Department of Motor Vehicles as proof of ownership.

New Owner Reported

When a vehicle is sold to a new owner, the Title must be transferred to the new owner(s) at a Department of Motor Vehicles.

Ownership History

CARFAX defines an owner as an individual or business that possesses and uses a vehicle. Not all title transactions represent changes in ownership. To provide estimated number of owners, CARFAX proprietary technology analyzes all the events in a vehicle history. Estimated ownership is available for vehicles manufactured after 1991 and titled solely in the US including Puerto Rico. Dealers sometimes opt to take ownership of a vehicle and are required to in the following states: Maine, Massachusetts, New Jersey, Ohio, Oklahoma, Pennsylvania and South Dakota. Please consider this as you review a vehicle's estimated ownership history.

Salvage Title



A Salvage Title is issued on a vehicle damaged to the extent that the cost of repairing the vehicle exceeds approximately 75% of its pre-damage value. This damage threshold may vary by state. Some states treat Junk titles the same as Salvage but the majority use this title to indicate that a vehicle is not road worthy and cannot be titled again in that state. The following eleven states also use Salvage titles to identify stolen vehicles - AZ, FL, GA, IL, MD, MN, NJ, NM, NY, OK and OR.

Title Issued

A state issues a title to provide a vehicle owner with proof of ownership. Each title has a unique number. Each title or registration record on a CARFAX report does not necessarily indicate a change in ownership. In Canada, a registration and bill of sale are used as proof of ownership.

Total Loss Vehicle

An insurance or fleet company declares a vehicle a total loss when a claim exceeds approximately 75% of its pre-damage value or if the vehicle is stolen and not recovered. This damage threshold varies by company. These companies typically take possession and obtain the title. Not all total loss vehicles result in a DMV-reported branded title. This may occur when an insurance company's definition of a total loss is different than the state DMV's definition for a branded title or when the owner of the vehicle is a self-insured company, like a fleet or rental company.

Follow Us:  facebook.com/CARFAX  [@CARFAXinc](https://twitter.com/CARFAXinc)  [About CARFAX](#)

CARFAX DEPENDS ON ITS SOURCES FOR THE ACCURACY AND RELIABILITY OF ITS INFORMATION. THEREFORE, NO RESPONSIBILITY IS ASSUMED BY CARFAX OR ITS AGENTS FOR ERRORS OR OMISSIONS IN THIS REPORT. CARFAX FURTHER EXPRESSLY DISCLAIMS ALL WARRANTIES, EXPRESS OR IMPLIED, INCLUDING ANY IMPLIED WARRANTIES OF MERCHANTABILITY OR FITNESS FOR A PARTICULAR PURPOSE.

© 2025 CARFAX, Inc., part of S&P Global. All rights reserved.
4/4/25 8:37:50 AM (CDT)

I have reviewed and received a copy of the CARFAX Vehicle History Report for this 2018 TESLA MODEL S vehicle (VIN: 5YJSA1E29JF291736), which is based on information supplied to CARFAX and available as of 4/4/25 at 9:37 AM (EDT).

Customer Signature

Date

Dealer Signature

Date

