

CARFAX History-Based Value Report

[Hide](#)

\$16,640

CARFAX Retail Value

Retail
 Wholesale

History events affecting this vehicle's value

Accident Reported

This CARFAX Vehicle History Report is based only on [information](#) supplied to CARFAX and available as of 12/20/24 at 8:45:01 AM (CST). Other information about this vehicle, including problems, may not have been reported to CARFAX. Use this report as one important tool, along with a vehicle inspection and test drive, to make a better decision about your next used car.

CARFAX Accident / Damage History

Not all accidents / issues are reported to CARFAX

Event 1

11/02/2017

Accident reported: minor damage ⓘ

- Vehicle involved in a rear-end collision with another motor vehicle

[View More Details >](#)

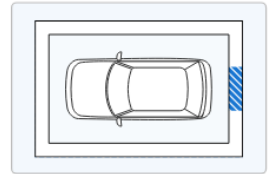
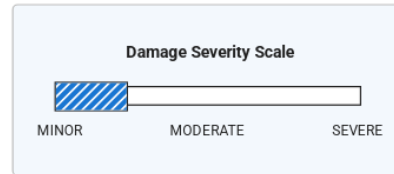

Event 2

03/30/2022

Accident reported: minor damage with another motor vehicle ⓘ

- Airbags did not deploy

[View More Details >](#)

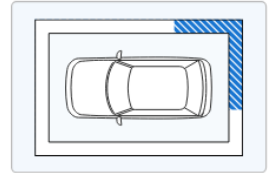
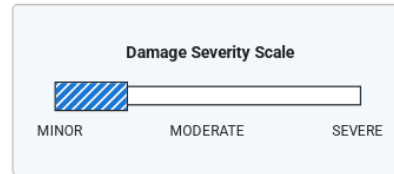

Event 3

05/18/2024

Accident reported: minor damage with another motor vehicle ⓘ

- Involving a parked motor vehicle

- Airbags did not deploy

[View More Details >](#)

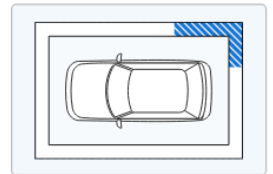
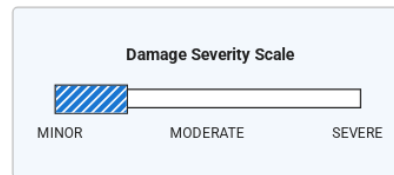

[Show More >](#)

CARFAX Additional History

Not all accidents / issues are reported to CARFAX

Owner 1

Owner 2

Total Loss ⓘ

No total loss reported to CARFAX.

No Issues Reported

No Issues Reported

Structural Damage ⓘ

CARFAX recommends that you have this vehicle inspected by a collision repair specialist.

No Issues Reported

No Issues Reported

Airbag Deployment ⓘ

No airbag deployment reported to CARFAX.

No Issues Reported

No Issues Reported

Odometer Check ⓘ No indication of an odometer rollback.	<input checked="" type="checkbox"/> No Issues Indicated	<input checked="" type="checkbox"/> No Issues Indicated
Accident / Damage ⓘ Accidents reported: 11/02/2017, 03/30/2022, 05/18/2024, 05/19/2024, and 11/30/2024.	Accident Reported	Accident Reported
Manufacturer Recall ⓘ Check with an authorized Tesla dealer for any open recalls.	Ask Your Dealer	Ask Your Dealer
Basic Warranty ⓘ Original warranty estimated to have expired.	Warranty Expired	Warranty Expired

Title History CARFAX guarantees the information in this section	Owner 1	Owner 2
Damage Brands ⓘ Salvage Junk Rebuilt Fire Flood Hail Lemon	<input checked="" type="checkbox"/> Guaranteed No Problem	<input checked="" type="checkbox"/> Guaranteed No Problem
Odometer Brands ⓘ Not Actual Mileage Exceeds Mechanical Limits	<input checked="" type="checkbox"/> Guaranteed No Problem	<input checked="" type="checkbox"/> Guaranteed No Problem
GUARANTEED - None of these title problems were reported by a U.S. state Department of Motor Vehicles (DMV). If you find that any of these title problems were reported by a DMV and not included in this report, you may qualify. View Terms View Certificate		

Ownership History The number of owners is estimated	Owner 1	Owner 2
Year purchased	2015	2024
Type of owner	Corporate	Personal
Estimated length of ownership	8 yrs. 5 mo.	7 months
Owned in the following states/provinces	Florida	Florida
Estimated miles driven per year	9,004/yr	—
Last reported odometer reading	76,351	76,381

Detailed History
[Glossary](#)

Owner 1 Purchased: 2015	<div style="border: 1px solid blue; padding: 5px; display: inline-block;"> Low mileage! This owner drove less than the industry average of 15,000 miles per year. </div>	Corporate Vehicle 9,004 mi/yr	
Date	Mileage	Source	Comments
07/31/2015	50	Florida Motor Vehicle Dept.	Vehicle purchase reported - Registration issued or renewed - Titled or registered as corporate vehicle - Vehicle color noted as Bronze
08/06/2015		Florida Motor Vehicle Dept. Naples, FL Title #0119764927	Title issued or updated - Registration issued or renewed - First owner reported - Vehicle color noted as Bronze
06/02/2016		Florida Motor Vehicle Dept.	Registration issued or renewed - Vehicle color noted as Bronze

06/02/2016

Florida
Motor Vehicle Dept.
Naples, FL
Title #0119764927

Registration issued or renewed
- Vehicle color noted as Bronze

05/19/2017

Florida
Motor Vehicle Dept.
Naples, FL
Title #0119764927

Registration issued or renewed
- Vehicle color noted as Bronze

11/02/2017

Damage Report



Accident reported: minor damage ⓘ
- Vehicle involved in a rear-end collision with another motor vehicle
- Damage to rear

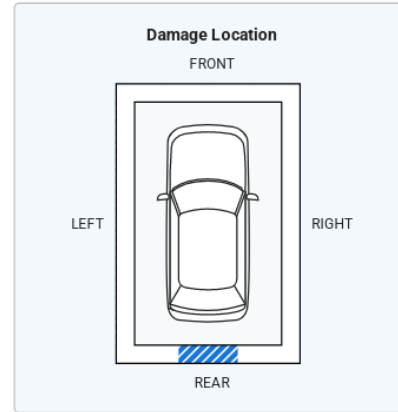
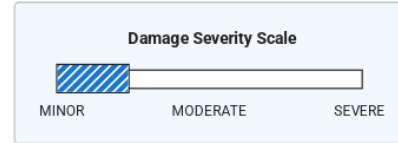

CARFAX HAS THE MOST ACCIDENT & DAMAGE INFORMATION



05/09/2019

Florida
Motor Vehicle Dept.
Naples, FL
Title #0119764927

Registration issued or renewed
- Vehicle color noted as Bronze

06/04/2021

Florida
Motor Vehicle Dept.
Naples, FL
Title #0119764927

Registration issued or renewed
- Vehicle color noted as Bronze

03/30/2022

Damage Report



Accident reported: minor damage with another motor vehicle ⓘ
- Damage to right rear
- Damage to rear
- Airbags did not deploy

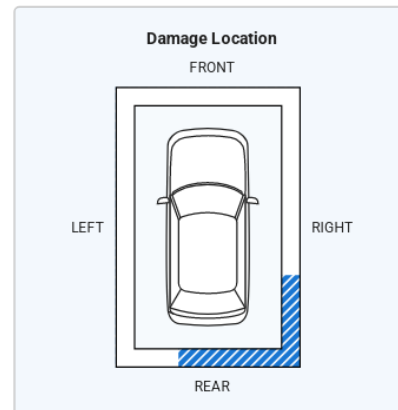
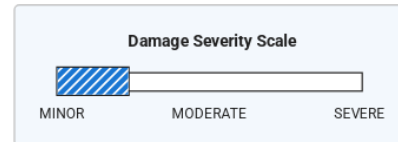

CARFAX HAS THE MOST ACCIDENT & DAMAGE INFORMATION



04/28/2023

Florida
Motor Vehicle Dept.
Naples, FL

Registration issued or renewed
- Vehicle color noted as Bronze

Motor Vehicle Dept.
Naples, FL
Title #0119764927

- Vehicle color noted as Bronze

01/09/2024

Online Listing

Vehicle offered for sale

01/18/2024

76,351

Germain Lexus of Naples
Naples, FL
239-592-5533
lexusofnaples.com

Vehicle sold

★ 4.8 / 5.0 [881 Verified Reviews](#)

♥ 8,930 Customer Favorites



Owner 2

Personal Vehicle

Purchased: 2024

Date	Mileage	Source	Comments
------	---------	--------	----------

05/11/2024

Westlake Financial
Los Angeles, CA
888-739-9192
westlakefinancial.com

Loan or lien reported

05/11/2024

76,381

Florida
Motor Vehicle Dept.
Fort Myers, FL
Title #0119764927

Vehicle purchase reported
- Registration issued or renewed
- Titled or registered as personal vehicle
- Vehicle color noted as Bronze

05/18/2024

Damage Report



Accident reported: minor damage with another motor vehicle ⓘ

- Involving a parked motor vehicle
- Damage to right rear
- Airbags did not deploy

CARFAX HAS THE MOST
ACCIDENT & DAMAGE
INFORMATION

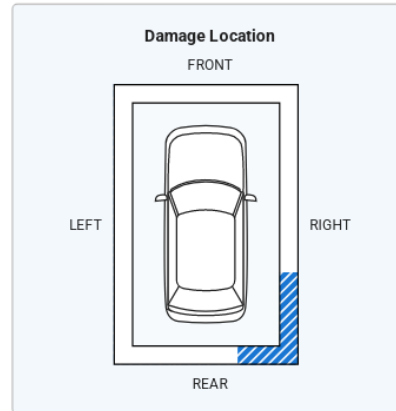
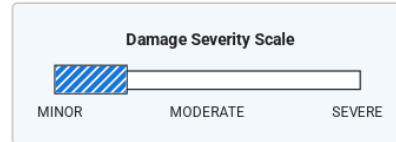

05/19/2024

Damage Report



Accident reported: minor damage ⓘ

- Airbags did not deploy

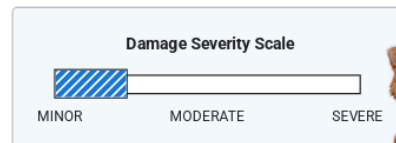

05/21/2024

Florida
Motor Vehicle Dept.
Fort Myers, FL
Title #0119764927

Title issued or updated
- Registration issued or renewed
- New owner reported
- Titled or registered as personal vehicle
- Loan or lien reported
- Registration updated when owner moved the vehicle to a new location
- Vehicle color noted as Bronze

new location
- Vehicle color noted as Bronze



Avoid financial headaches. Make sure the loan has been paid off if you're buying from a private seller. [Learn More](#)

11/30/2024

Damage Report



Accident reported with another motor vehicle

- Damage to right front
- Damage to right rear
- Disabling damage reported
- Vehicle towed
- Airbags did not deploy

CARFAX HAS THE MOST ACCIDENT & DAMAGE INFORMATION

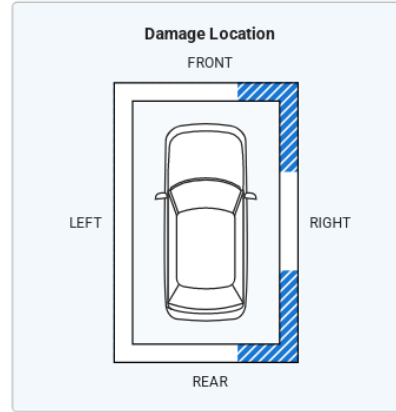

Have Questions? Consumers, please visit our Help Center at www.carfax.com. Dealers or Subscribers, please visit our Help Center at www.carfaxonline.com.

Accident Indicator

CARFAX receives information about accidents in all 50 states, the District of Columbia and Canada.

Not every accident is reported to CARFAX. As details about the accident become available, those additional details are added to the CARFAX Vehicle History Report. CARFAX recommends that you have this vehicle inspected by a qualified mechanic.

- According to the National Safety Council, Injury Facts, 2021 edition, 5% of the 276 million registered vehicles in the U.S. were involved in an accident in 2019. Over 77% of these were considered minor or moderate.
- This CARFAX Vehicle History Report is based only on information supplied to CARFAX and available as of 12/20/24 at 8:45:01 AM (CST). Other information about this vehicle, including problems, may not have been reported to CARFAX. Use this report as one important tool, along with a vehicle inspection and test drive, to make a better decision about your next used car.

Damage Severity

Damage events result in one of the following severity levels:

- Minor: Generally, minor damage is cosmetic (including dents or scratches), may only require reconditioning, and typically does not compromise a vehicle's operation and/or safety.
- Moderate: Moderate damage may affect multiple components of the vehicle and may impair the vehicle's operation and/or safety.
- Severe: Severe damage usually affects multiple components of the vehicle and is likely to compromise the vehicle's operation and/or safety.

CARFAX recommends getting a pre-purchase inspection at a certified collision repair facility.

First Owner

When the first owner(s) obtains a title from a Department of Motor Vehicles as proof of ownership.

New Owner Reported

When a vehicle is sold to a new owner, the Title must be transferred to the new owner(s) at a Department of Motor Vehicles.

Ownership History

CARFAX defines an owner as an individual or business that possesses and uses a vehicle. Not all title transactions represent changes in ownership. To provide estimated number of owners, CARFAX proprietary technology analyzes all the events in a vehicle history. Estimated ownership is available for vehicles manufactured after 1991 and titled solely in the US including Puerto Rico. Dealers sometimes opt to take ownership of a vehicle and are required to in the following states: Maine, Massachusetts, New Jersey, Ohio, Oklahoma, Pennsylvania and South Dakota. Please consider this as you review a vehicle's estimated ownership history.

Title Issued

A state issues a title to provide a vehicle owner with proof of ownership. Each title has a unique number. Each title or registration record on a CARFAX report does not necessarily indicate a change in ownership. In Canada, a registration and bill of sale are used as proof of ownership.

necessarily indicate a change in ownership. In Canada, a registration and bill of sale are used as proof of ownership.

Follow Us: facebook.com/CARFAX @CARFAXinc About CARFAX

CARFAX DEPENDS ON ITS SOURCES FOR THE ACCURACY AND RELIABILITY OF ITS INFORMATION. THEREFORE, NO RESPONSIBILITY IS ASSUMED BY CARFAX OR ITS AGENTS FOR ERRORS OR OMISSIONS IN THIS REPORT. CARFAX FURTHER EXPRESSLY DISCLAIMS ALL WARRANTIES, EXPRESS OR IMPLIED, INCLUDING ANY IMPLIED WARRANTIES OF MERCHANTABILITY OR FITNESS FOR A PARTICULAR PURPOSE.

© 2024 CARFAX, Inc., part of S&P Global. All rights reserved.
12/20/24 8:45:01 AM (CST)

I have reviewed and received a copy of the CARFAX Vehicle History Report for this 2015 TESLA MODEL S vehicle (VIN: 5YJSA1H25FF092928), which is based on information supplied to CARFAX and available as of 12/20/24 at 9:45 AM (EST).

Customer Signature

Date

Dealer Signature

Date

CARFAX History-Based Value Report

[Hide](#)

\$16,640

CARFAX Retail Value

Retail Wholesale

History events affecting this vehicle's value

↓ ⚠ Accident Reported

CARFAX Vehicle History Report™

US \$44.99

2015 TESLA MODEL S 85D

VIN: 5YJSA1H25FF092928
HATCHBACK 4 DR
X 0V
ELECTRIC
ALL WHEEL DRIVE

⚠ Accident reported >

👤 2 Previous owners >

🚗 Types of owners: Corporate, Personal >

🌐 Last owned in Florida >

📁 17 Detailed records available >

📊 76,381 Last reported odometer reading >

CARFAX HAS THE MOST ACCIDENT & DAMAGE INFORMATION



This CARFAX Vehicle History Report is based only on [information](#) supplied to CARFAX and available as of 12/20/24 at 8:45:01 AM (CST). Other information about this vehicle, including problems, may not have been reported to CARFAX. Use this report as one important tool, along with a vehicle inspection and test drive, to make a better decision about your next used car.

CARFAX Accident / Damage History

Not all accidents / issues are reported to CARFAX

Event 1

11/02/2017

Accident reported: minor damage ⓘ

- Vehicle involved in a rear-end collision with another motor vehicle

Damage Severity Scale

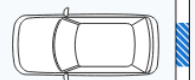
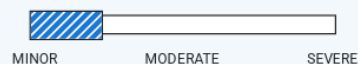

[View More Details >](#)

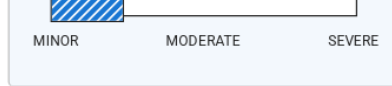

Event 2

03/30/2022

Accident reported: minor damage with another motor vehicle ⓘ

- Airbags did not deploy

[View More Details >](#)

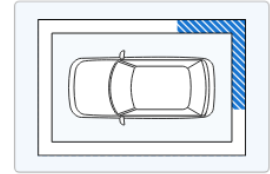
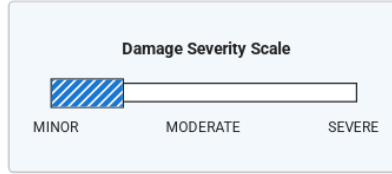

Event 3

05/18/2024

Accident reported: minor damage with another motor vehicle ⓘ

- Involving a parked motor vehicle

- Airbags did not deploy

[View More Details >](#)

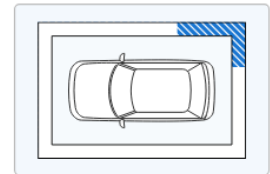
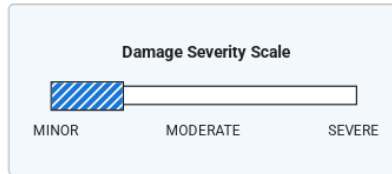

[Show More >](#)



Additional History

Not all accidents / issues are reported to CARFAX

Owner 1

Owner 2

Total Loss ⓘ

No total loss reported to CARFAX.

✓ No Issues Reported

✓ No Issues Reported

Structural Damage ⓘ

CARFAX recommends that you have this vehicle inspected by a collision repair specialist.

✓ No Issues Reported

✓ No Issues Reported

Airbag Deployment ⓘ

No airbag deployment reported to CARFAX.

✓ No Issues Reported

✓ No Issues Reported

Odometer Check ⓘ

No indication of an odometer rollback.

✓ No Issues Indicated

✓ No Issues Indicated

Accident / Damage ⓘ

Accidents reported: 11/02/2017, 03/30/2022, 05/18/2024, 05/19/2024, and 11/30/2024.

[Accident Reported](#)

[Accident Reported](#)

Manufacturer Recall ⓘ

Check with an authorized Tesla dealer for any open recalls.

Ask Your Dealer

Ask Your Dealer

Basic Warranty ⓘ

[Original warranty](#) estimated to have expired.

Warranty Expired

Warranty Expired



Title History

CARFAX guarantees the information in this section

Owner 1

Owner 2

Damage Brands ⓘ

Salvage | Junk | Rebuilt | Fire | Flood | Hail | Lemon

✓ **Guaranteed**
No Problem

✓ **Guaranteed**
No Problem

Odometer Brands ⓘ

Not Actual Mileage | Exceeds Mechanical Limits

✓ **Guaranteed**
No Problem

✓ **Guaranteed**
No Problem



GUARANTEED - None of these title problems were reported by a U.S. state Department of Motor Vehicles (DMV). If you find that any of these title problems were reported by a DMV and not included in this report, you may qualify.

[View Terms](#) | [View Certificate](#)



Ownership History

The number of owners is estimated

Owner 1

Owner 2

Year purchased	2015	2024
Type of owner	Corporate	Personal
Estimated length of ownership	8 yrs. 5 mo.	7 months
Owned in the following states/provinces	Florida	Florida
Estimated miles driven per year	9,004/yr	—
Last reported odometer reading	76,351	76,381



Detailed History

[Glossary](#)

Owner 1
Purchased: 2015



Low mileage! This owner drove less than the industry average of 15,000 miles per year.

Corporate Vehicle
9,004 mi/yr

Date	Mileage	Source	Comments
07/31/2015	50	Florida Motor Vehicle Dept.	Vehicle purchase reported - Registration issued or renewed - Titled or registered as corporate vehicle - Vehicle color noted as Bronze
08/06/2015		Florida Motor Vehicle Dept. Naples, FL Title #0119764927	Title issued or updated - Registration issued or renewed - First owner reported - Vehicle color noted as Bronze
06/02/2016		Florida Motor Vehicle Dept. Naples, FL Title #0119764927	Registration issued or renewed - Vehicle color noted as Bronze
05/19/2017		Florida Motor Vehicle Dept. Naples, FL Title #0119764927	Registration issued or renewed - Vehicle color noted as Bronze

11/02/2017

Damage Report





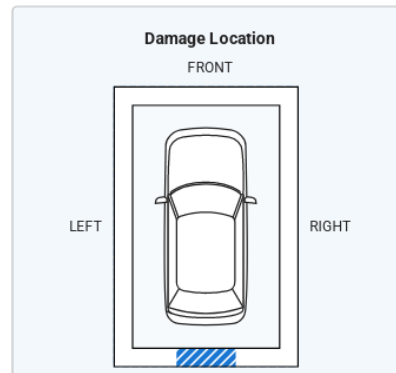
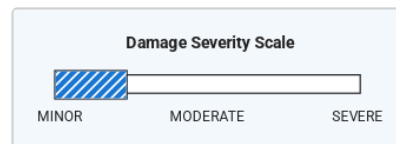

Accident reported: minor damage ⓘ

- Vehicle involved in a rear-end collision with another motor vehicle
- Damage to rear



CARFAX HAS THE MOST ACCIDENT & DAMAGE INFORMATION

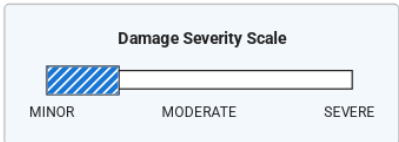
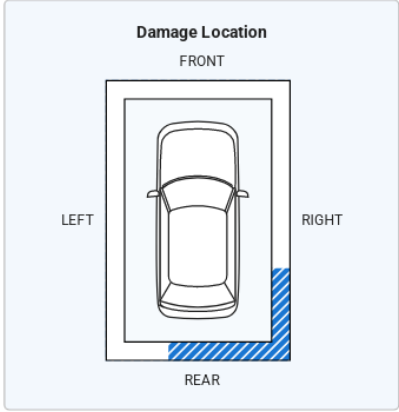

05/09/2019	Florida Motor Vehicle Dept. Naples, FL Title #0119764927	Registration issued or renewed - Vehicle color noted as Bronze
06/04/2021	Florida Motor Vehicle Dept. Naples, FL Title #0119764927	Registration issued or renewed - Vehicle color noted as Bronze
03/30/2022	Damage Report	 Accident reported: minor damage with another motor vehicle  - Damage to right rear - Damage to rear - Airbags did not deploy
		
		
04/28/2023	Florida Motor Vehicle Dept. Naples, FL Title #0119764927	Registration issued or renewed - Vehicle color noted as Bronze
01/09/2024	Online Listing	Vehicle offered for sale
01/18/2024	76,351 Germain Lexus of Naples Naples, FL 239-592-5533 lexusofnaples.com ★ 4.8 / 5.0 881 Verified Reviews  ❤️ 8,930 Customer Favorites	Vehicle sold

CARFAX HAS THE MOST ACCIDENT & DAMAGE INFORMATION

 **Owner 2** Personal Vehicle
Purchased: 2024

Date	Mileage	Source	Comments
05/11/2024		Westlake Financial Los Angeles, CA 888-739-9192 westlakefinancial.com	Loan or lien reported
05/11/2024	76,381	Florida Motor Vehicle Dept. Fort Myers, FL Title #0119764927	Vehicle purchase reported - Registration issued or renewed - Titled or registered as personal vehicle - Vehicle color noted as Bronze

05/18/2024	Damage Report	 Accident reported: minor damage with another motor
------------	---------------	---

05/18/2024

Damage Report



Accident reported: minor damage with another motor vehicle ⓘ

- Involving a parked motor vehicle
- Damage to right rear
- Airbags did not deploy

CARFAX HAS THE MOST ACCIDENT & DAMAGE INFORMATION

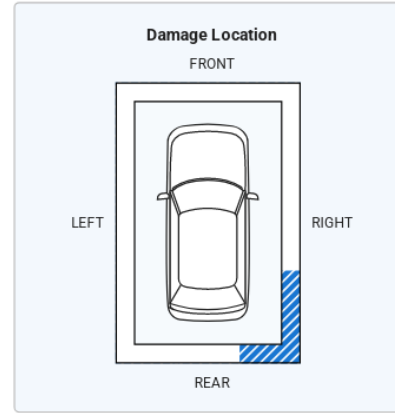
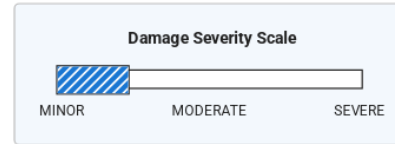

05/19/2024

Damage Report



Accident reported: minor damage ⓘ

- Airbags did not deploy

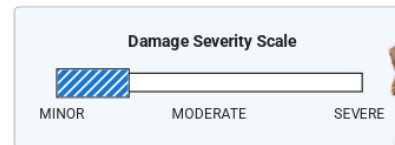

05/21/2024

Florida
Motor Vehicle Dept.
Fort Myers, FL
Title #0119764927

Title issued or updated

- Registration issued or renewed
- New owner reported
- Titled or registered as personal vehicle
- Loan or lien reported
- Registration updated when owner moved the vehicle to a new location
- Vehicle color noted as Bronze



Avoid financial headaches. Make sure the loan has been paid off if you're buying from a private seller. [Learn More](#)

11/30/2024

Damage Report



Accident reported with another motor vehicle

- Damage to right front
- Damage to right rear
- Disabling damage reported
- Vehicle towed
- Airbags did not deploy

CARFAX HAS THE MOST ACCIDENT & DAMAGE INFORMATION

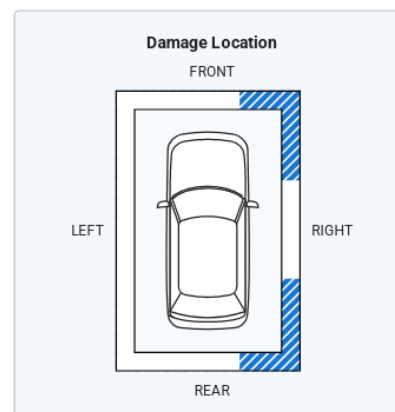

CARFAX Glossary

Accident Indicator

CARFAX receives information about accidents in all 50 states, the District of Columbia and Canada.

Not every accident is reported to CARFAX. As details about the accident become available, those additional details are added to the CARFAX Vehicle History Report. CARFAX recommends that you have this vehicle inspected by a qualified mechanic.

- According to the National Safety Council, Injury Facts, 2021 edition, 5% of the 276 million registered vehicles in the U.S. were involved in an accident in 2019. Over 77% of these were considered minor or moderate.
- This CARFAX Vehicle History Report is based only on information supplied to CARFAX and available as of 12/20/24 at 8:45:01 AM (CST). Other information about this vehicle, including problems, may not have been reported to CARFAX. Use this report as one important tool, along with a vehicle inspection and test drive, to make a better decision about your next used car.

Damage Severity

Damage events result in one of the following severity levels:

- Minor: Generally, minor damage is cosmetic (including dents or scratches), may only require reconditioning, and typically does not compromise a vehicle's operation and/or safety.
- Moderate: Moderate damage may affect multiple components of the vehicle and may impair the vehicle's operation and/or safety.
- Severe: Severe damage usually affects multiple components of the vehicle and is likely to compromise the vehicle's operation and/or safety.

CARFAX recommends getting a pre-purchase inspection at a certified collision repair facility.

First Owner

When the first owner(s) obtains a title from a Department of Motor Vehicles as proof of ownership.

New Owner Reported

When a vehicle is sold to a new owner, the Title must be transferred to the new owner(s) at a Department of Motor Vehicles.

Ownership History

CARFAX defines an owner as an individual or business that possesses and uses a vehicle. Not all title transactions represent changes in ownership. To provide estimated number of owners, CARFAX proprietary technology analyzes all the events in a vehicle history. Estimated ownership is available for vehicles manufactured after 1991 and titled solely in the US including Puerto Rico. Dealers sometimes opt to take ownership of a vehicle and are required to in the following states: Maine, Massachusetts, New Jersey, Ohio, Oklahoma, Pennsylvania and South Dakota. Please consider this as you review a vehicle's estimated ownership history.

Title Issued

A state issues a title to provide a vehicle owner with proof of ownership. Each title has a unique number. Each title or registration record on a CARFAX report does not necessarily indicate a change in ownership. In Canada, a registration and bill of sale are used as proof of ownership.

Follow Us:  facebook.com/CARFAX  [@CARFAXinc](https://twitter.com/CARFAXinc)  [About CARFAX](#)

CARFAX DEPENDS ON ITS SOURCES FOR THE ACCURACY AND RELIABILITY OF ITS INFORMATION. THEREFORE, NO RESPONSIBILITY IS ASSUMED BY CARFAX OR ITS AGENTS FOR ERRORS OR OMISSIONS IN THIS REPORT. CARFAX FURTHER EXPRESSLY DISCLAIMS ALL WARRANTIES, EXPRESS OR IMPLIED, INCLUDING ANY IMPLIED WARRANTIES OF MERCHANTABILITY OR FITNESS FOR A PARTICULAR PURPOSE.

© 2024 CARFAX, Inc., part of S&P Global. All rights reserved.
12/20/24 8:45:01 AM (CST)

I have reviewed and received a copy of the CARFAX Vehicle History Report for this 2015 TESLA MODEL S vehicle (VIN: 5YJSA1H25FF092928), which is based on information supplied to CARFAX and available as of 12/20/24 at 9:45 AM (EST).

Customer Signature

Date

Dealer Signature

Date

