

## CARFAX History-Based Value Report

**\$21,110**

CARFAX Retail Value

### History events affecting this vehicle's value

- 1-Owner Vehicle
- Personal Vehicle
- Total Loss
- Airbag Deployed

## CARFAX Vehicle History Report™

US \$44.99

### 2018 TESLA MODEL X 75D

VIN: 5YJXCAE2XJF104567  
4 DOOR WAGON/SPORT UTILITY  
ELECTRIC  
ALL WHEEL DRIVE

- Accident reported: total loss vehicle >
- CARFAX 1-Owner vehicle >
- Personal vehicle >
- Last owned in Texas >
- 9 Detailed records available >
- 59,744 Last reported odometer reading >

This CARFAX Vehicle History Report is based only on [information](#) supplied to CARFAX and available as of 2/12/26 at 1:11:58 PM (CST). Other information about this vehicle, including problems, may not have been reported to CARFAX. Use this report as one important tool, along with a vehicle inspection and test drive, to make a better decision about your next used car.

## CARFAX Accident / Damage History

Not all accidents / issues are reported to CARFAX

### Event 1

12/04/2025

#### TOTAL LOSS VEHICLE

- Accident reported
- Vehicle declared a total loss by an insurance company
- Damage to undercarriage

[View More Details >](#)

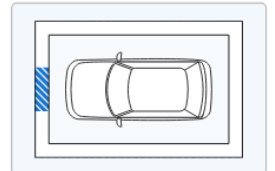

### Event 2



12/12/2025

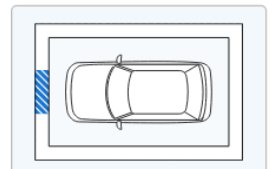
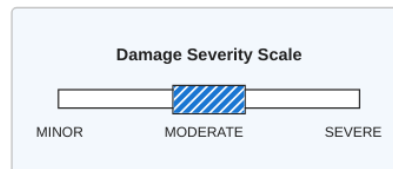

#### Damage reported: moderate damage ⓘ

- Airbag deployed



[View More Details >](#)



 <b>Additional History</b> Not all accidents / issues are reported to CARFAX		 Owner 1
<b>Total Loss</b> ⓘ Total Loss Reported: 12/04/2025.	<a href="#">Total Loss Reported</a>	
<b>Structural Damage</b> ⓘ CARFAX recommends that you have this vehicle inspected by a collision repair specialist.	<input checked="" type="checkbox"/> No Issues Reported	
<b>Airbag Deployment</b> ⓘ Airbag deployment reported: 12/12/2025.	<a href="#">Airbag Deployment</a>	
<b>Odometer Check</b> ⓘ No indication of an odometer rollback.	<input checked="" type="checkbox"/> No Issues Indicated	
<b>Accident / Damage</b> ⓘ Accident reported: 12/04/2025. Damage reported: 12/12/2025.	<a href="#">Accident Reported</a>	
<b>Manufacturer Recall</b> ⓘ Check with an authorized Tesla dealer for any open recalls.	<b>Ask Your Dealer</b>	
<b>Basic Warranty</b> ⓘ <a href="#">Original warranty</a> estimated to have expired.	<b>Warranty Expired</b>	

 <b>Title History</b> CARFAX guarantees the information in this section		 Owner 1
<b>Damage Brands</b> ⓘ Salvage   Junk   Rebuilt   Fire   Flood   Hail   Lemon	<input checked="" type="checkbox"/> <b>Guaranteed</b> No Problem	
<b>Odometer Brands</b> ⓘ Not Actual Mileage   Exceeds Mechanical Limits	<input checked="" type="checkbox"/> <b>Guaranteed</b> No Problem	
 <b>GUARANTEED</b> - None of these title problems were reported by a U.S. state Department of Motor Vehicles (DMV). If you find that any of these title problems were reported by a DMV and not included in this report, you may qualify. <a href="#">View Terms</a>   <a href="#">View Certificate</a>		

 <b>Ownership History</b> The number of owners is estimated		 Owner 1
Year purchased	2018	
Type of owner	Personal	
Estimated length of ownership	7 yrs. 6 mo.	
Owned in the following states/provinces	Texas	
Estimated miles driven per year	7,981/yr	
Last reported odometer reading	59,744	

 <b>Detailed History</b>		<a href="#">Glossary</a>
 <b>Owner 1</b> Purchased: 2018	Personal Vehicle 7,981 mi/yr	
Date	Mileage	Source
Comments		

Date	Mileage	Source	Comments
07/25/2018	50	Texas Motor Vehicle Dept. Houston, TX Title #10155643296150106	<b>Title issued or updated</b> - First owner reported - Titled or registered as personal vehicle - Loan or lien reported - Vehicle color noted as Black
08/23/2019		Texas Motor Vehicle Dept. Houston, TX Title #10155643296150106	<b>Registration issued or renewed</b> - Loan or lien reported - Passed safety inspection - Vehicle color noted as Black
01/28/2022		Texas Motor Vehicle Dept. Houston, TX Title #10155643296150106	<b>Registration issued or renewed</b> - Loan or lien reported - Passed safety inspection - Vehicle color noted as Black
04/30/2023		Texas Motor Vehicle Dept. Houston, TX Title #10155643296150106	<b>Registration issued or renewed</b> - Loan or lien reported - Passed safety inspection - Vehicle color noted as Black
01/01/2024		Texas Motor Vehicle Dept. Houston, TX Title #10155643296150106	<b>Registration issued or renewed</b> - Loan or lien reported - Passed safety inspection - Vehicle color noted as Black
02/02/2025		Texas Motor Vehicle Dept. Houston, TX Title #10155643296150106	<b>Registration issued or renewed</b> - Loan or lien reported - Passed safety inspection - Vehicle color noted as Black

12/04/2025      Damage Report       **TOTAL LOSS VEHICLE**  
 - Accident reported  
 - Vehicle declared a total loss by an insurance company  
 - Damage to front  
 - Damage to undercarriage

**CARFAX HAS THE MOST ACCIDENT & DAMAGE INFORMATION**

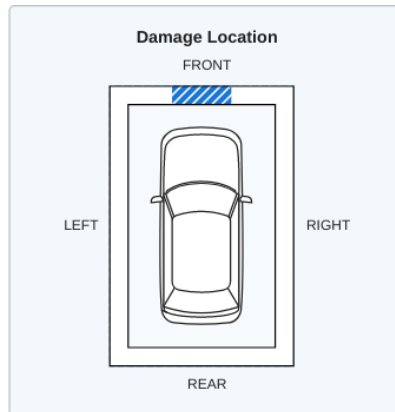

There are many reasons an insurance company will declare a vehicle a total loss. Have this vehicle inspected by a qualified technician before you buy. [Learn More](#)

12/12/2025      Damage Report       **Damage reported: moderate damage** ⓘ  
 - Damage to front  
 - Airbag deployed  
[CARFAX Airbag Tips](#)

**CARFAX HAS THE MOST ACCIDENT & DAMAGE INFORMATION**

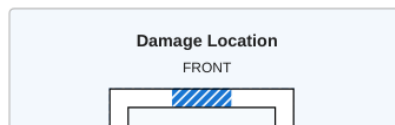
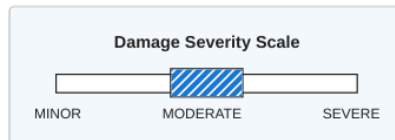

## CARFAX HAS THE MOST ACCIDENT & DAMAGE INFORMATION

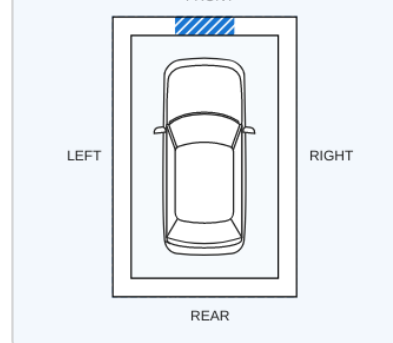

01/16/2026

59,744

Texas  
Motor Vehicle Dept.  
Austin, TX  
Title #01130946028250111

**Title or registration issued to insurance company**  
- Vehicle color noted as Black

Have Questions? Consumers, please visit our Help Center at [www.carfax.com](http://www.carfax.com). Dealers or Subscribers, please visit our Help Center at [www.carfaxonline.com](http://www.carfaxonline.com).

## CARFAX Glossary

[Full Glossary](#)

### Accident Indicator

CARFAX receives information about accidents in all 50 states, the District of Columbia and Canada.

Not every accident is reported to CARFAX. As details about the accident become available, those additional details are added to the CARFAX Vehicle History Report. CARFAX recommends that you have this vehicle inspected by a qualified mechanic.

- According to the National Safety Council, Injury Facts, 2021 edition, 5% of the 276 million registered vehicles in the U.S. were involved in an accident in 2019. Over 77% of these were considered minor or moderate.
- This CARFAX Vehicle History Report is based only on information supplied to CARFAX and available as of 2/12/26 at 1:11:58 PM (CST). Other information about this vehicle, including problems, may not have been reported to CARFAX. Use this report as one important tool, along with a vehicle inspection and test drive, to make a better decision about your next used car.

### Airbag Deployment

Occurs when the driver, passenger or side airbag has been used or deployed during a crash or other incident. If an airbag has been deployed, it must be replaced by a qualified technician. Have this car inspected by a mechanic prior to purchase.

### Damage Indicator

Damage can be a result of many different types of events. Examples include contact with objects (other cars, trees, traffic signs, road debris, etc), vandalism, or weather-related events. Not every damage event is reported to CARFAX. As details about the damage event become available, those additional details are added to the CARFAX Vehicle History Report. CARFAX recommends that you have this vehicle inspected by a qualified mechanic.

- This CARFAX Vehicle History Report is based only on information supplied to CARFAX and available as of 2/12/26 at 1:11:58 PM (CST). Other information about this vehicle, including problems, may not have been reported to CARFAX. Use this report as one important tool, along with a vehicle inspection and test drive, to make a better decision about your next used car.

### Damage Severity

Damage events result in one of the following severity levels:

- Minor: Generally, minor damage is cosmetic (including dents or scratches), may only require reconditioning, and typically does not compromise a vehicle's operation and/or safety.
- Moderate: Moderate damage may affect multiple components of the vehicle and may impair the vehicle's operation and/or safety.
- Severe: Severe damage usually affects multiple components of the vehicle and is likely to compromise the vehicle's operation and/or safety.

CARFAX recommends getting a pre-purchase inspection at a certified collision repair facility.

### First Owner

When the first owner(s) obtains a title from a Department of Motor Vehicles as proof of ownership.

### Ownership History

CARFAX defines an owner as an individual or business that possesses and uses a vehicle. Not all title transactions represent changes in ownership. To provide estimated number of owners, CARFAX proprietary technology analyzes all the events in a vehicle history. Estimated ownership is available for vehicles manufactured after 1991 and titled solely in the US including Puerto Rico. Dealers sometimes opt to take ownership of a vehicle and are required to in the following states: Maine, Massachusetts, New Jersey, Ohio, Oklahoma, Pennsylvania and South Dakota. Please consider this as you review a vehicle's estimated ownership history.

### Title Issued

A state issues a title to provide a vehicle owner with proof of ownership. Each title has a unique number. Each title or registration record on a CARFAX report does not necessarily indicate a change in ownership. In Canada, a registration and bill of sale are used as proof of ownership.

### Total Loss Vehicle

An insurance or fleet company declares a vehicle a total loss when a claim exceeds approximately 75% of its pre-damage value or if the vehicle is stolen and not recovered. This damage threshold varies by company. These companies typically take possession and obtain the title. Not all total loss vehicles result in a DMV-reported branded title. This may occur when an insurance company's definition of a total loss is different than the state DMV's definition for a branded title or when the

recovered. This damage threshold varies by company. These companies typically take possession and obtain the title. Not all total loss vehicles result in a DMV-reported branded title. This may occur when an insurance company's definition of a total loss is different than the state DMV's definition for a branded title or when the owner of the vehicle is a self-insured company, like a fleet or rental company.

Follow  
Us:



[facebook.com/CARFAX](https://facebook.com/CARFAX)



[@CARFAXinc](https://twitter.com/CARFAXinc)



[About CARFAX](#)

CARFAX DEPENDS ON ITS SOURCES FOR THE ACCURACY AND RELIABILITY OF ITS INFORMATION. THEREFORE, NO RESPONSIBILITY IS ASSUMED BY CARFAX OR ITS AGENTS FOR ERRORS OR OMISSIONS IN THIS REPORT. CARFAX FURTHER EXPRESSLY DISCLAIMS ALL WARRANTIES, EXPRESS OR IMPLIED, INCLUDING ANY IMPLIED WARRANTIES OF MERCHANTABILITY OR FITNESS FOR A PARTICULAR PURPOSE.

© 2026 CARFAX, Inc., part of S&P Global. All rights reserved.  
2/12/26 1:11:58 PM (CST)

**I have reviewed and received a copy of the CARFAX Vehicle History Report for this 2018 TESLA MODEL X vehicle (VIN: 5YJXCAE2XJF104567), which is based on information supplied to CARFAX and available as of 2/12/26 at 2:11 PM (EST).**

\_\_\_\_\_  
Customer Signature

\_\_\_\_\_  
Date

\_\_\_\_\_  
Dealer Signature

\_\_\_\_\_  
Date