

## CARFAX History-Based Value Report

[Hide](#)

# \$23,560

CARFAX Retail Value

Retail
  Wholesale

### History events affecting this vehicle's value

- 1-Owner Vehicle
- Service History
- Salvage Brand
- Airbag Deployed

## CARFAX Vehicle History Report™

US \$44.99

### 2019 TESLA MODEL X LONG RANGE

VIN: 5YJXCBE21KF180203  
 4 DOOR WAGON/SPORT UTILITY  
 X 0V  
 ELECTRIC  
 ALL WHEEL DRIVE

- Branded Title: Salvage >
- 6 Service history records >
- CARFAX 1-Owner vehicle >
- Personal vehicle >
- Last owned in Texas >
- 114,294 Last reported odometer reading >

CARFAX HAS THE MOST ACCIDENT & DAMAGE INFORMATION



This CARFAX Vehicle History Report is based only on [information](#) supplied to CARFAX and available as of 5/12/25 at 7:11:51 AM (CDT). Other information about this vehicle, including problems, may not have been reported to CARFAX. Use this report as one important tool, along with a vehicle inspection and test drive, to make a better decision about your next used car.

## CARFAX Accident / Damage History

Not all accidents / issues are reported to CARFAX

### Event 1

10/15/2019

**Damage reported: minor damage**

[View More Details >](#)

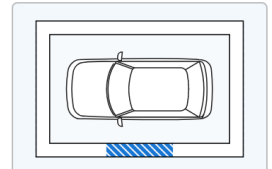
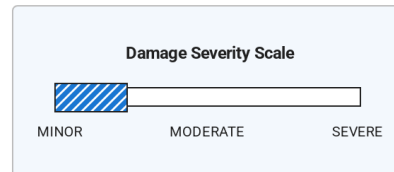

### Event 2

11/16/2020

**Accident reported**

- Multiple airbags deployed

[View More Details >](#)

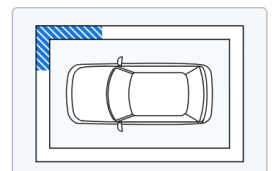

### Event 3

12/10/2022

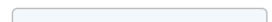
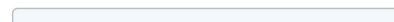

12/19/2022

**Accident reported: minor to moderate damage** ⓘ

- Vehicle towed
- Airbags did not deploy

[View More Details >](#)

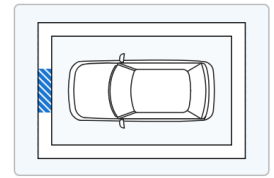
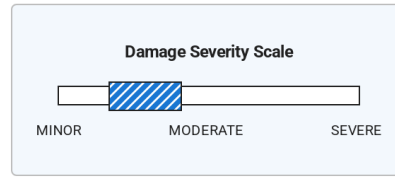

[Show More](#) ▾

**CARFAX** Recent Service Highlights

Key services performed in the last 12 months

Service	Comments	Date	
Tires	✓ Tire(s) replaced	05/14/2024	<a href="#">View Details &gt;</a>
 <div style="border: 1px solid #ccc; padding: 5px; display: inline-block;">This car has been recently serviced. That's a good thing!</div>			

**CARFAX** Additional History

Not all accidents / issues are reported to CARFAX

Owner 1

**Total Loss** ⓘ

Total Loss Reported: 04/02/2025.

[Total Loss Reported](#)

**Structural Damage** ⓘ

CARFAX recommends that you have this vehicle inspected by a collision repair specialist.

✓ No Issues Reported

**Airbag Deployment** ⓘ

Airbag deployment reported: 11/16/2020.

[Airbag Deployment](#)

**Odometer Check** ⓘ

No indication of an odometer rollback.

✓ No Issues Indicated

**Accident / Damage** ⓘ

DMV title problems reported. Damage reported: 10/15/2019. Accidents reported: 11/16/2020, 12/19/2022, and 04/02/2025.

[Severe Damage](#)

**Manufacturer Recall** ⓘ

Check with an authorized Tesla dealer for any open recalls.

**Ask Your Dealer**

**Basic Warranty** ⓘ

Original manufacturer warranty likely voided by manufacturer.

**Warranty Voided**

**CARFAX** Title History

Owner 1

**Damage Brands** ⓘ

Salvage | Junk | Rebuilt | Fire | Flood | Hail | Lemon

**Alert!**  
Problem Found

**Odometer Brands** ⓘ

Not Actual Mileage | Exceeds Mechanical Limits

No Problem

 **ALERT!** - Severe problems were reported by a state Department of Motor Vehicles (DMV). This vehicle does not qualify for the CARFAX Buyback Guarantee.

**CARFAX** Ownership History

The number of owners is estimated

Owner 1

Year purchased	2019
Type of owner	Personal
Estimated length of ownership	5 yrs. 8 mo.
Owned in the following states/provinces	Texas
Estimated miles driven per year	20,008/yr
Last reported odometer reading	114,294



**CARFAX** Detailed History

[Glossary](#)

Owner 1

Purchased: 2019

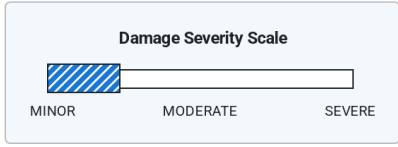
Personal Vehicle  
20,008 mi/yr

Date	Mileage	Source	Comments
07/18/2019	50	Texas Motor Vehicle Dept. Houston, TX Title #10156043654142739	<b>Title issued or updated</b> - First owner reported - Titled or registered as personal vehicle - Loan or lien reported - Vehicle color noted as Black
10/15/2019		Damage Report	<p><b>Damage reported: minor damage</b></p> <p>- Damage to left side</p> <div style="display: flex; align-items: center;"> <div style="flex: 1;"> <p><b>CARFAX HAS THE MOST ACCIDENT &amp; DAMAGE INFORMATION</b></p>  </div> <div style="flex: 1;"> <p><b>Damage Severity Scale</b></p>  <p><b>Damage Location</b></p>  </div> </div>
05/12/2020	18,546	Elite Lube & Inspection Pasadena, TX 281-991-1100 elite-autogroup.com ★ 4.8 / 5.0 <a href="#">82 Verified Reviews</a> ♥ 29 Customer Favorites	<p><b>Vehicle serviced</b></p> <p>- Safety inspection performed</p>
05/29/2020	19,967	Elite Carwash & Auto Repair Houston, TX 281-280-9400 elite-autogroup.com ★ 4.4 / 5.0 <a href="#">198 Verified Reviews</a> ♥ 11 Customer Favorites	<p><b>Vehicle serviced</b></p> <p>- Vehicle washed/detailed</p>
07/01/2020		Texas	<b>Registration issued or renewed</b>

07/01/2020

Texas  
Motor Vehicle Dept.  
Houston, TX  
Title #10156043654142739

**Registration issued or renewed**

- Loan or lien reported
- Passed safety inspection
- Vehicle color noted as Black

11/16/2020

Damage Report



**Accident reported**

- Damage to right front
  - Multiple airbags deployed
- [CARFAX Airbag Tips](#)

**CARFAX HAS THE MOST ACCIDENT & DAMAGE INFORMATION**

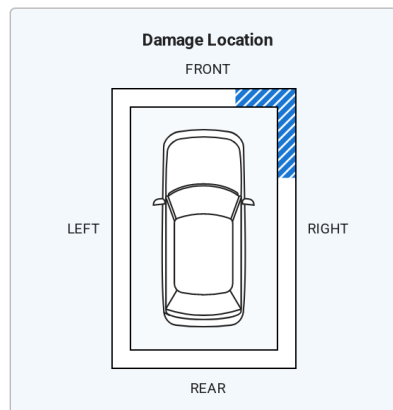

07/01/2021

Texas  
Motor Vehicle Dept.  
Houston, TX  
Title #10156043654142739

**Registration issued or renewed**

- Loan or lien reported
- Passed safety inspection
- Registration updated when owner moved the vehicle to a new location
- Vehicle color noted as Black

07/01/2022

Texas  
Motor Vehicle Dept.  
Houston, TX  
Title #10156043654142739

**Registration issued or renewed**

- Loan or lien reported
- Passed safety inspection
- Registration updated when owner moved the vehicle to a new location
- Vehicle color noted as Black

11/12/2022

Tires By Design  
Houston, TX  
281-487-2028  
tiresbydesign.com



**Vehicle serviced**

- Tire(s) mounted

★ 4.8 / 5.0 [60 Verified Reviews](#) ✓

♥ 205 Customer Favorites

12/19/2022

Damage Report



**Accident reported: minor to moderate damage** ⓘ

- Damage to front
- Vehicle towed
- Airbags did not deploy



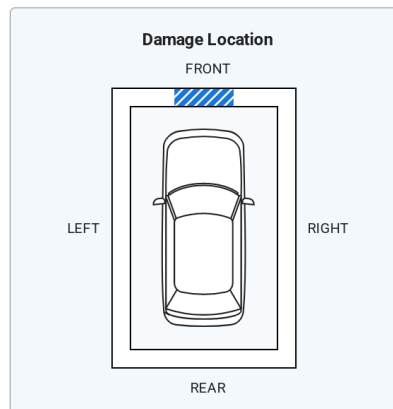
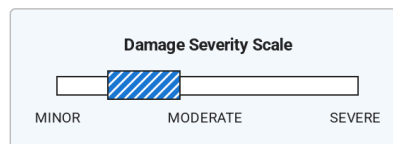





**CARFAX HAS THE MOST ACCIDENT & DAMAGE INFORMATION**



07/01/2023

Texas

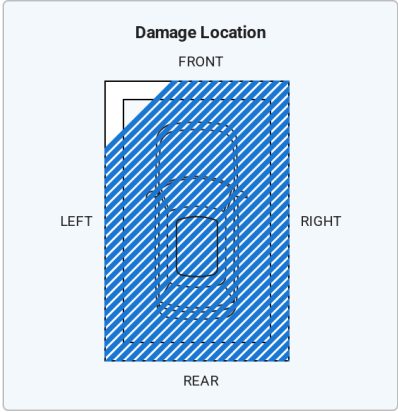
**Registration issued or renewed**

07/01/2023		Texas Motor Vehicle Dept. Houston, TX Title #10156043654142739		<b>Registration issued or renewed</b> - Loan or lien reported - Passed safety inspection - Vehicle color noted as Black
04/02/2024		Tires By Design Houston, TX 281-487-2028 tiresbydesign.com ★ 4.8 / 5.0 <a href="#">60 Verified Reviews</a> ✓ ♥ 205 Customer Favorites		<b>Vehicle serviced</b> - Tire(s) mounted
05/14/2024	101,211	Tires By Design Houston, TX 281-487-2028 tiresbydesign.com ★ 4.8 / 5.0 <a href="#">60 Verified Reviews</a> ✓ ♥ 205 Customer Favorites		<b>Vehicle serviced</b> - Tire(s) mounted - Tire(s) replaced
05/28/2024		Tires By Design Houston, TX 281-487-2028 tiresbydesign.com ★ 4.8 / 5.0 <a href="#">60 Verified Reviews</a> ✓ ♥ 205 Customer Favorites		<b>Vehicle serviced</b> - Tire repaired
07/01/2024		Texas Motor Vehicle Dept. Houston, TX Title #10156043654142739		<b>Registration issued or renewed</b> - Loan or lien reported - Passed safety inspection - Vehicle color noted as Black
03/12/2025		Texas Motor Vehicle Dept. Houston, TX Title #28695345725006677		<b>Title issued or updated</b> - Loan or lien released - Vehicle color noted as Black
04/02/2025		Damage Report		<b>TOTAL LOSS VEHICLE</b> - Accident reported - Damage to undercarriage - Damage to roof
<p><b>CARFAX HAS THE MOST ACCIDENT &amp; DAMAGE INFORMATION</b></p>  		 <p>There are many reasons an insurance company will declare a vehicle a total loss. Have this vehicle inspected by a qualified technician before you buy. <a href="#">Learn More</a></p>		
04/02/2025		Texas Motor Vehicle Dept.		<b>Title or registration issued to insurance company</b>
04/02/2025	114,294	Texas Motor Vehicle Dept. Houston, TX Title #29758045745250206		<b>SALVAGE TITLE/CERTIFICATE ISSUED</b> - Vehicle color noted as Black



Have Questions? Consumers, please visit our Help Center at [www.carfax.com](http://www.carfax.com). Dealers or Subscribers, please visit our Help Center at [www.carfaxonline.com](http://www.carfaxonline.com).

### Accident Indicator

CARFAX receives information about accidents in all 50 states, the District of Columbia and Canada.

Not every accident is reported to CARFAX. As details about the accident become available, those additional details are added to the CARFAX Vehicle History Report. CARFAX recommends that you have this vehicle inspected by a qualified mechanic.

- According to the National Safety Council, Injury Facts, 2021 edition, 5% of the 276 million registered vehicles in the U.S. were involved in an accident in 2019. Over 77% of these were considered minor or moderate.
- This CARFAX Vehicle History Report is based only on information supplied to CARFAX and available as of 5/12/25 at 7:11:51 AM (CDT). Other information about this vehicle, including problems, may not have been reported to CARFAX. Use this report as one important tool, along with a vehicle inspection and test drive, to make a better decision about your next used car.

### Airbag Deployment

Occurs when the driver, passenger or side airbag has been used or deployed during a crash or other incident. If an airbag has been deployed, it must be replaced by a qualified technician. Have this car inspected by a mechanic prior to purchase.

### Damage Indicator

Damage can be a result of many different types of events. Examples include contact with objects (other cars, trees, traffic signs, road debris, etc), vandalism, or weather-related events. Not every damage event is reported to CARFAX. As details about the damage event become available, those additional details are added to the CARFAX Vehicle History Report. CARFAX recommends that you have this vehicle inspected by a qualified mechanic.

- This CARFAX Vehicle History Report is based only on information supplied to CARFAX and available as of 5/12/25 at 7:11:51 AM (CDT). Other information about this vehicle, including problems, may not have been reported to CARFAX. Use this report as one important tool, along with a vehicle inspection and test drive, to make a better decision about your next used car.

### Damage Severity

Damage events result in one of the following severity levels:

- Minor: Generally, minor damage is cosmetic (including dents or scratches), may only require reconditioning, and typically does not compromise a vehicle's operation and/or safety.
- Moderate: Moderate damage may affect multiple components of the vehicle and may impair the vehicle's operation and/or safety.
- Severe: Severe damage usually affects multiple components of the vehicle and is likely to compromise the vehicle's operation and/or safety.

CARFAX recommends getting a pre-purchase inspection at a certified collision repair facility.

### First Owner

When the first owner(s) obtains a title from a Department of Motor Vehicles as proof of ownership.

### Ownership History

CARFAX defines an owner as an individual or business that possesses and uses a vehicle. Not all title transactions represent changes in ownership. To provide estimated number of owners, CARFAX proprietary technology analyzes all the events in a vehicle history. Estimated ownership is available for vehicles manufactured after 1991 and titled solely in the US including Puerto Rico. Dealers sometimes opt to take ownership of a vehicle and are required to in the following states: Maine, Massachusetts, New Jersey, Ohio, Oklahoma, Pennsylvania and South Dakota. Please consider this as you review a vehicle's estimated ownership history.

### Salvage Title

A Salvage Title is issued on a vehicle damaged to the extent that the cost of repairing the vehicle exceeds approximately 75% of its pre-damage value. This damage threshold may vary by state. Some states treat Junk titles the same as Salvage but the majority use this title to indicate that a vehicle is not road worthy and cannot be titled again in that state. The following eleven states also use Salvage titles to identify stolen vehicles - AZ, FL, GA, IL, MD, MN, NJ, NM, NY, OK and OR.

### Title Issued

A state issues a title to provide a vehicle owner with proof of ownership. Each title has a unique number. Each title or registration record on a CARFAX report does not necessarily indicate a change in ownership. In Canada, a registration and bill of sale are used as proof of ownership.

### Total Loss Vehicle

An insurance or fleet company declares a vehicle a total loss when a claim exceeds approximately 75% of its pre-damage value or if the vehicle is stolen and not recovered. This damage threshold varies by company. These companies typically take possession and obtain the title. Not all total loss vehicles result in a DMV-reported branded title. This may occur when an insurance company's definition of a total loss is different than the state DMV's definition for a branded title or when the owner of the vehicle is a self-insured company, like a fleet or rental company.

CARFAX DEPENDS ON ITS SOURCES FOR THE ACCURACY AND RELIABILITY OF ITS INFORMATION. THEREFORE, NO RESPONSIBILITY IS ASSUMED BY CARFAX OR ITS AGENTS FOR ERRORS OR OMISSIONS IN THIS REPORT. CARFAX FURTHER EXPRESSLY DISCLAIMS ALL WARRANTIES, EXPRESS OR IMPLIED, INCLUDING ANY IMPLIED WARRANTIES OF MERCHANTABILITY OR FITNESS FOR A PARTICULAR PURPOSE.

© 2025 CARFAX, Inc., part of S&P Global. All rights reserved.

5/12/25 7:11:51 AM (CDT)

**I have reviewed and received a copy of the CARFAX Vehicle History Report for this 2019 TESLA MODEL X vehicle (VIN: 5YJXCBE21KF180203), which is based on information supplied to CARFAX and available as of 5/12/25 at 8:11 AM (EDT).**

---

**Customer Signature**

**Date**

---

**Dealer Signature**

**Date**