

CARFAX History-Based Value Report [Hide](#)

\$20,560

CARFAX Retail Value

Retail Wholesale

History events affecting this vehicle's value

- Personal Vehicle
- Accident Reported

CARFAX Vehicle History Report™ US \$44.99

2016 TESLA MODEL X 90D

VIN: 5YJXCBE25GF002608
4 DOOR WAGON/SPORT UTILITY
ELECTRIC
ALL WHEEL DRIVE

- Accident reported >
- 2 Service history records >
- 3 Previous owners >
- Personal vehicle >
- Last owned in Texas >
- 121,463** Last reported odometer reading >

CARFAX HAS THE MOST ACCIDENT & DAMAGE INFORMATION



This CARFAX Vehicle History Report is based only on [information](#) supplied to CARFAX and available as of 6/26/25 at 11:14:26 AM (CDT). Other information about this vehicle, including problems, may not have been reported to CARFAX. Use this report as one important tool, along with a vehicle inspection and test drive, to make a better decision about your next used car.

CARFAX Accident / Damage History

Not all accidents / issues are reported to CARFAX

Event 1

12/02/2020

Damage reported: very minor damage ⓘ

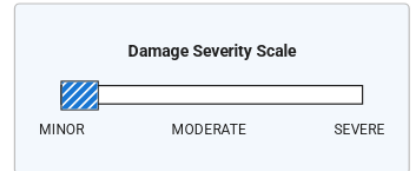

Event 2

05/13/2021

Damage reported

[View More Details >](#)

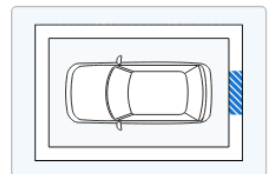

Event 3

02/19/2024

Accident reported: minor damage ⓘ

- Vehicle involved in a rear-end collision
- Airbags did not deploy

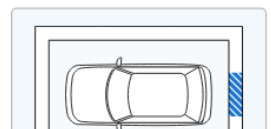
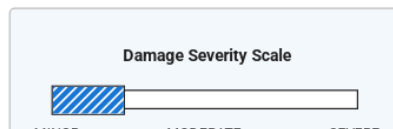

- Vehicle involved in a rear-end collision
- Airbags did not deploy

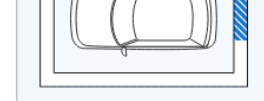
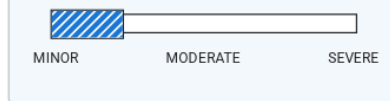

[View More Details >](#)

[Show More >](#)

CARFAX Additional History Not all accidents / issues are reported to CARFAX	Owner 1	Owner 2	Owner 3
Total Loss ⓘ No total loss reported to CARFAX.	✓ No Issues Reported	✓ No Issues Reported	✓ No Issues Reported
Structural Damage ⓘ CARFAX recommends that you have this vehicle inspected by a collision repair specialist.	✓ No Issues Reported	✓ No Issues Reported	✓ No Issues Reported
Airbag Deployment ⓘ No airbag deployment reported to CARFAX.	✓ No Issues Reported	✓ No Issues Reported	✓ No Issues Reported
Odometer Check ⓘ No indication of an odometer rollback.	✓ No Issues Indicated	✓ No Issues Indicated	✓ No Issues Indicated
Accident / Damage ⓘ Damage reported: 12/02/2020 and 05/13/2021. Accidents reported: 02/19/2024 and 06/20/2025.	Damage Reported	Damage Reported	Accident Reported
Manufacturer Recall ⓘ Check with an authorized Tesla dealer for any open recalls.	Ask Your Dealer	Ask Your Dealer	Ask Your Dealer
Basic Warranty ⓘ Original warranty estimated to have expired.	Warranty Expired	Warranty Expired	Warranty Expired

CARFAX Title History CARFAX guarantees the information in this section	Owner 1	Owner 2	Owner 3
Damage Brands ⓘ Salvage Junk Rebuilt Fire Flood Hail Lemon	✓ Guaranteed No Problem	✓ Guaranteed No Problem	✓ Guaranteed No Problem
Odometer Brands ⓘ Not Actual Mileage Exceeds Mechanical Limits	✓ Guaranteed No Problem	✓ Guaranteed No Problem	✓ Guaranteed No Problem



GUARANTEED - None of these title problems were reported by a U.S. state Department of Motor Vehicles (DMV). If you find that any of these title problems were reported by a DMV and not included in this report, you may qualify.
[View Terms](#) | [View Certificate](#)





CARFAX Ownership History The number of owners is estimated	Owner 1	Owner 2	Owner 3
Year purchased	2016	2021	2023
Type of owner	Personal	Personal	Personal
Estimated length of ownership	4 yrs. 11 mo.	1 yr. 3 mo.	2 yrs. 2 mo.
Owned in the following states/provinces	Nevada, New York	New York	Texas
Estimated miles driven per year	15,432/yr	--	11,340/yr
Last reported odometer reading	75,132	96,789	121,463

Owner 1

Purchased: 2016

Personal Vehicle

15,432 mi/yr





Date	Mileage	Source	Comments
04/12/2016	50	Nevada Motor Vehicle Dept. Las Vegas, NV Title #NV008561248-7	Title issued or updated - First owner reported - Titled or registered as personal vehicle
04/29/2016		Nevada Motor Vehicle Dept. Los Angeles, CA	Registration issued or renewed - Registration updated when owner moved the vehicle to a new location
03/21/2017		Nevada Motor Vehicle Dept. Los Angeles, CA	Registration issued or renewed
04/10/2018		Nevada Motor Vehicle Dept. Los Angeles, CA	Registration issued or renewed
04/19/2019		Nevada Motor Vehicle Dept. Los Angeles, CA	Registration issued or renewed
11/04/2019	66,159	David Wilson's Toyota of Las Vegas Las Vegas, NV 702-457-2000 dwtoyotalasvegas.com ★ 4.3 / 5.0 618 Verified Reviews ✓ ♥ 13,135 Customer Favorites	 Vehicle serviced
05/03/2020		Nevada Motor Vehicle Dept. Los Angeles, CA	Registration issued or renewed
12/02/2020		Damage Report	 Damage reported: very minor damage  <div style="border: 1px solid #ccc; padding: 5px; display: flex; align-items: center;"> <div style="text-align: center; flex: 1;"> <p>Damage Severity Scale</p> <div style="display: flex; justify-content: space-between; align-items: center;"> <div style="width: 20%;"></div> <div style="width: 60%; border-bottom: 1px solid #ccc;"></div> <div style="width: 20%;"></div> </div> <div style="display: flex; justify-content: space-between; font-size: 8px; margin-top: 2px;"> MINOR MODERATE SEVERE </div> </div>  </div>
02/22/2021	75,132	New York Inspection Station	Dealer had vehicle inspected to prepare it for sale - Passed safety inspection - Emissions inspection performed
02/28/2021		New York Motor Vehicle Dept. Port Washington, NY	Registration issued or renewed - Titled or registered as personal vehicle - Passed safety inspection
03/03/2021		Nevada Motor Vehicle Dept. Los Angeles, CA	Registration issued or renewed

Owner 2

Purchased: 2021

Personal Vehicle

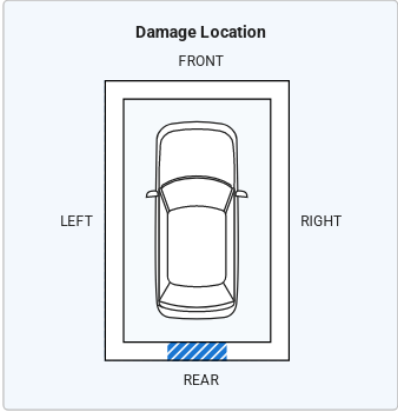
Date	Mileage	Source	Comments
------	---------	--------	----------

Date	Mileage	Source	Comments
03/23/2021		New York Motor Vehicle Dept. Port Washington, NY	Title issued or updated - New owner reported - Loan or lien reported
05/13/2021		Damage Report	 Damage reported - Damage to rear
<div style="display: flex; align-items: center;"> <div style="flex: 1;"> <p>CARFAX HAS THE MOST ACCIDENT & DAMAGE INFORMATION</p> </div> <div style="flex: 1; text-align: center;">  </div> <div style="flex: 1;"> <div style="border: 1px solid #ccc; padding: 10px; text-align: center;"> <p>Damage Location</p> <p>FRONT</p>  <p>LEFT RIGHT</p> <p>REAR</p> </div> <div style="margin-top: 20px;">  <div style="border: 1px solid #00aaff; padding: 5px; display: inline-block;"> <p>Not all damage is caused by an accident. Get the car inspected before you buy. Learn More</p> </div> </div> </div> </div>			
03/02/2022	91,354	New York Inspection Station	Passed safety inspection - Emissions inspection performed
06/17/2022	96,000	New Hampshire Inspection Station Hillsborough County	Odometer reading reported
06/24/2022	96,173	Online Listing	Vehicle offered for sale
06/24/2022		Auto Auction	Vehicle sold
<div style="display: flex; align-items: center;"> <div style="flex: 1;"></div> <div style="flex: 1; text-align: center;">  <div style="border: 1px solid #00aaff; padding: 5px; display: inline-block;"> <p>Millions of used vehicles are bought and sold at auction every year.</p> </div> </div> </div>			
07/30/2022	96,789	Online Listing	Vehicle offered for sale
08/01/2022		Auto Auction	Vehicle sold
08/02/2022		Auto Centrix Carrollton, TX	Vehicle offered for sale
<div style="display: flex; align-items: center;"> <div style="flex: 1;"></div> <div style="flex: 1; text-align: center;"> <p>★ 4.4 / 5.0 8 Verified Reviews ✓</p> </div> </div>			



Owner 3
Purchased: 2023



Low mileage! This owner drove less than the industry average of 15,000 miles per year.

Personal Vehicle
11,340 mi/yr

Date	Mileage	Source	Comments
04/13/2023	96,949	Texas Motor Vehicle Dept. Dallas, TX Title #05750945019100026	Title issued or updated - New owner reported - Loan or lien reported - Vehicle color noted as Blue

02/19/2024		Damage Report	 Accident reported: minor damage ⓘ - Vehicle involved in a rear-end collision - Damage to rear - Airbags did not deploy
------------	--	---------------	--

CARFAX HAS THE MOST ACCIDENT & DAMAGE INFORMATION

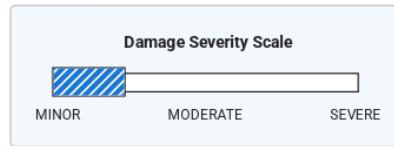

05/18/2024 109,475 Take 5 Oil Change
 Dallas, TX
 214-278-6278
 take5oilchangeemockingbirdln.com/
 ★ 4.7 / 5.0 [229 Verified Reviews](#) ✓
 ♥ 137 Customer Favorites



Vehicle serviced
 - Safety inspection performed

05/18/2024 Texas
 Motor Vehicle Dept.
 Dallas, TX
 Title #05750945019100026

Registration issued or renewed
 - Loan or lien reported
 - Passed safety inspection
 - Vehicle color noted as Blue

04/01/2025 Texas
 Motor Vehicle Dept.
 Dallas, TX
 Title #05750945019100026

Registration issued or renewed
 - Loan or lien reported
 - Passed safety inspection
 - Vehicle color noted as Blue

05/15/2025 Texas
 Motor Vehicle Dept.
 Dallas, TX
 Title #28695345789009129

Title issued or updated
 - Loan or lien released
 - Vehicle color noted as Blue

06/10/2025 121,463 Texas
 Motor Vehicle Dept.
 Justin, TX
 Title #01130945808250117

Title or registration issued to insurance company
 - Vehicle color noted as Blue

06/20/2025 Damage Report



Accident reported
 - Damage to front

CARFAX HAS THE MOST ACCIDENT & DAMAGE INFORMATION

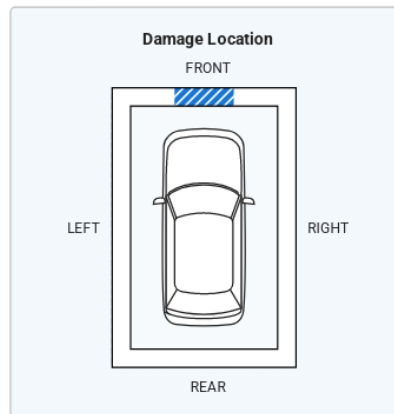

Accident Indicator

CARFAX receives information about accidents in all 50 states, the District of Columbia and Canada.

Not every accident is reported to CARFAX. As details about the accident become available, those additional details are added to the CARFAX Vehicle History Report. CARFAX recommends that you have this vehicle inspected by a qualified mechanic.

- According to the National Safety Council, Injury Facts, 2021 edition, 5% of the 276 million registered vehicles in the U.S. were involved in an accident in 2019. Over 77% of these were considered minor or moderate.
- This CARFAX Vehicle History Report is based only on information supplied to CARFAX and available as of 6/26/25 at 11:14:26 AM (CDT). Other information about this vehicle, including problems, may not have been reported to CARFAX. Use this report as one important tool, along with a vehicle inspection and test drive, to make a better decision about your next used car.

Damage Indicator

Damage can be a result of many different types of events. Examples include contact with objects (other cars, trees, traffic signs, road debris, etc), vandalism, or weather-related events. Not every damage event is reported to CARFAX. As details about the damage event become available, those additional details are added to the CARFAX Vehicle History Report. CARFAX recommends that you have this vehicle inspected by a qualified mechanic.

- This CARFAX Vehicle History Report is based only on information supplied to CARFAX and available as of 6/26/25 at 11:14:26 AM (CDT). Other information about this vehicle, including problems, may not have been reported to CARFAX. Use this report as one important tool, along with a vehicle inspection and test drive, to make a better decision about your next used car.

Damage Severity

Damage events result in one of the following severity levels:

- Minor: Generally, minor damage is cosmetic (including dents or scratches), may only require reconditioning, and typically does not compromise a vehicle's operation and/or safety.
- Moderate: Moderate damage may affect multiple components of the vehicle and may impair the vehicle's operation and/or safety.
- Severe: Severe damage usually affects multiple components of the vehicle and is likely to compromise the vehicle's operation and/or safety.

CARFAX recommends getting a pre-purchase inspection at a certified collision repair facility.

First Owner

When the first owner(s) obtains a title from a Department of Motor Vehicles as proof of ownership.

New Owner Reported



When a vehicle is sold to a new owner, the Title must be transferred to the new owner(s) at a Department of Motor Vehicles.

Ownership History

CARFAX defines an owner as an individual or business that possesses and uses a vehicle. Not all title transactions represent changes in ownership. To provide estimated number of owners, CARFAX proprietary technology analyzes all the events in a vehicle history. Estimated ownership is available for vehicles manufactured after 1991 and titled solely in the US including Puerto Rico. Dealers sometimes opt to take ownership of a vehicle and are required to in the following states: Maine, Massachusetts, New Jersey, Ohio, Oklahoma, Pennsylvania and South Dakota. Please consider this as you review a vehicle's estimated ownership history.

Title Issued

A state issues a title to provide a vehicle owner with proof of ownership. Each title has a unique number. Each title or registration record on a CARFAX report does not necessarily indicate a change in ownership. In Canada, a registration and bill of sale are used as proof of ownership.

Follow Us:  facebook.com/CARFAX  [@CARFAXinc](https://twitter.com/CARFAXinc)  [About CARFAX](#)

CARFAX DEPENDS ON ITS SOURCES FOR THE ACCURACY AND RELIABILITY OF ITS INFORMATION. THEREFORE, NO RESPONSIBILITY IS ASSUMED BY CARFAX OR ITS AGENTS FOR ERRORS OR OMISSIONS IN THIS REPORT. CARFAX FURTHER EXPRESSLY DISCLAIMS ALL WARRANTIES, EXPRESS OR IMPLIED, INCLUDING ANY IMPLIED WARRANTIES OF MERCHANTABILITY OR FITNESS FOR A PARTICULAR PURPOSE.

© 2025 CARFAX, Inc., part of S&P Global. All rights reserved.
6/26/25 11:14:26 AM (CDT)

I have reviewed and received a copy of the CARFAX Vehicle History Report for this 2016 TESLA MODEL X vehicle (VIN: 5YJXCBE25GF002608), which is based on information supplied to CARFAX and available as of 6/26/25 at 12:14 PM (EDT).

Customer Signature

Date

Dealer Signature

Date

