

CARFAX History-Based Value Report

[Hide](#)

\$17,760

CARFAX Retail Value

Retail
 Wholesale

History events affecting this vehicle's value

- 1-Owner Vehicle
- Personal Vehicle
- Salvage Brand
- Airbag Deployed

CARFAX Vehicle History Report™

US \$44.99

2021 TESLA MODEL Y LONG RANGE

VIN: 5YJYGDEE0MF204377
 4 DOOR WAGON/SPORT UTILITY
 ELECTRIC
 ALL WHEEL DRIVE

Branded Title: Salvage >

CARFAX 1-Owner vehicle >

Personal vehicle >

Last owned in North Carolina >

7 Detailed records available >

41,187 Last reported odometer reading >

CARFAX HAS THE MOST ACCIDENT & DAMAGE INFORMATION



This CARFAX Vehicle History Report is based only on [information](#) supplied to CARFAX and available as of 6/16/25 at 1:08:25 AM (CDT). Other information about this vehicle, including problems, may not have been reported to CARFAX. Use this report as one important tool, along with a vehicle inspection and test drive, to make a better decision about your next used car.

CARFAX Accident / Damage History

Not all accidents / issues are reported to CARFAX

Event 1

01/04/2024

Accident reported with another motor vehicle

[View More Details >](#)

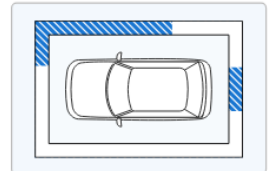

Event 2

04/24/2025

Accident reported: moderate to severe damage

- Vehicle ran off road
- It hit a tree
- Vehicle disabled
- Vehicle towed
- Multiple airbags deployed

[View More Details >](#)

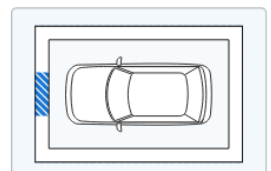
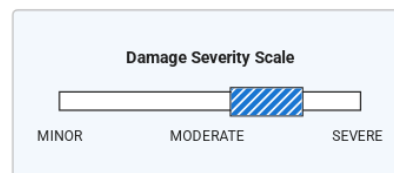

[View More Details >](#)

Event 3

05/29/2025

TOTAL LOSS VEHICLE

- SALVAGE TITLE/CERTIFICATE ISSUED

[View More Details >](#)

CARFAX Additional History

Not all accidents / issues are reported to CARFAX

Owner 1

Total Loss ⓘ

Total Loss Reported: 05/29/2025.

[Total Loss Reported](#)

Structural Damage ⓘ

CARFAX recommends that you have this vehicle inspected by a collision repair specialist.

✔ No Issues Reported

Airbag Deployment ⓘ

Airbag deployment reported: 04/24/2025.

[Airbag Deployment](#)

Odometer Check ⓘ

No indication of an odometer rollback.

✔ No Issues Indicated

Accident / Damage ⓘ

DMV title problems reported. Accidents reported: 01/04/2024 and 04/24/2025.

[Severe Damage](#)

Manufacturer Recall ⓘ

Check with an authorized Tesla dealer for any open recalls.

Ask Your Dealer

Basic Warranty ⓘ

Original manufacturer warranty likely voided by manufacturer.

Warranty Voided

CARFAX Title History

Owner 1

Damage Brands ⓘ

Salvage | Junk | Rebuilt | Fire | Flood | Hail | Lemon

Alert!
Problem Found

Odometer Brands ⓘ

Not Actual Mileage | Exceeds Mechanical Limits

No Problem

ALERT! - Severe problems were reported by a state Department of Motor Vehicles (DMV). This vehicle does not qualify for the CARFAX Buyback Guarantee.

CARFAX Ownership History

The number of owners is estimated

Owner 1

Year purchased

2021

Type of owner

Personal

Estimated length of ownership

3 yrs. 11 mo.

Owned in the following states/provinces

Massachusetts, North Carolina

Estimated miles driven per year

10,432/yr

Last reported odometer reading

41,187

CARFAX Detailed History



[Glossary](#)

Owner 1

Personal Vehicle

Purchased: 2021

10,432 mi/yr

Date	Mileage	Source	Comments
06/18/2021	15	Massachusetts Motor Vehicle Dept. Holliston, MA Title #CD067340	Vehicle purchase reported - Title issued or updated - Registration issued or renewed - First owner reported - Titled or registered as personal vehicle - Loan or lien reported - Vehicle color noted as White
05/01/2023		Massachusetts Motor Vehicle Dept. Holliston, MA Title #CD067340	Registration issued or renewed - Loan or lien reported - Registration updated when owner moved the vehicle to a new location - Vehicle color noted as White
01/04/2024		Damage Report	 Accident reported with another motor vehicle - Damage to rear - Damage to right front - Damage to right side
09/18/2024	32,600	North Carolina Motor Vehicle Dept. Charlotte, NC Title #579357242628182	Title or registration issued - Loan or lien reported
04/24/2025		Damage Report	 Accident reported: moderate to severe damage  <ul style="list-style-type: none"> - Vehicle ran off road - It hit a tree - Damage to front - Vehicle disabled - Vehicle towed - Multiple airbags deployed CARFAX Airbag Tips

CARFAX HAS THE MOST ACCIDENT & DAMAGE INFORMATION



CARFAX HAS THE MOST ACCIDENT & DAMAGE INFORMATION

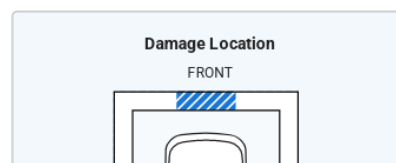
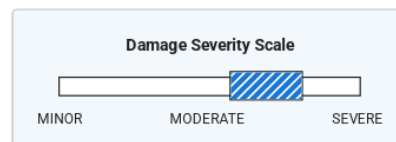

ACCIDENT & DAMAGE INFORMATION

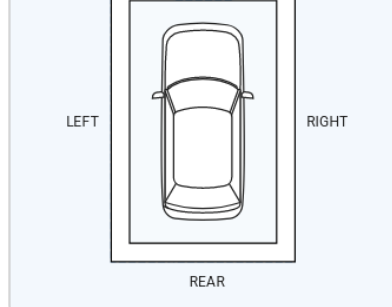

05/29/2025

North Carolina
Motor Vehicle Dept.

Title or registration issued to insurance company

05/29/2025

41,187

North Carolina
Motor Vehicle Dept.
Clayton, NC
Title #40013125149881F



TOTAL LOSS VEHICLE
- SALVAGE TITLE/CERTIFICATE ISSUED



There are many reasons an insurance company will declare a vehicle a total loss. Have this vehicle inspected by a qualified technician before you buy. [Learn More](#)

Have Questions? Consumers, please visit our Help Center at www.carfax.com. Dealers or Subscribers, please visit our Help Center at www.carfaxonline.com.

Accident Indicator

CARFAX receives information about accidents in all 50 states, the District of Columbia and Canada.

Not every accident is reported to CARFAX. As details about the accident become available, those additional details are added to the CARFAX Vehicle History Report. CARFAX recommends that you have this vehicle inspected by a qualified mechanic.

- According to the National Safety Council, Injury Facts, 2021 edition, 5% of the 276 million registered vehicles in the U.S. were involved in an accident in 2019. Over 77% of these were considered minor or moderate.
- This CARFAX Vehicle History Report is based only on information supplied to CARFAX and available as of 6/16/25 at 1:08:25 AM (CDT). Other information about this vehicle, including problems, may not have been reported to CARFAX. Use this report as one important tool, along with a vehicle inspection and test drive, to make a better decision about your next used car.

Airbag Deployment

Occurs when the driver, passenger or side airbag has been used or deployed during a crash or other incident. If an airbag has been deployed, it must be replaced by a qualified technician. Have this car inspected by a mechanic prior to purchase.

Damage Indicator

Damage can be a result of many different types of events. Examples include contact with objects (other cars, trees, traffic signs, road debris, etc), vandalism, or weather-related events. Not every damage event is reported to CARFAX. As details about the damage event become available, those additional details are added to the CARFAX Vehicle History Report. CARFAX recommends that you have this vehicle inspected by a qualified mechanic.

- This CARFAX Vehicle History Report is based only on information supplied to CARFAX and available as of 6/16/25 at 1:08:25 AM (CDT). Other information about this vehicle, including problems, may not have been reported to CARFAX. Use this report as one important tool, along with a vehicle inspection and test drive, to make a better decision about your next used car.

Damage Severity

Damage events result in one of the following severity levels:

- Minor: Generally, minor damage is cosmetic (including dents or scratches), may only require reconditioning, and typically does not compromise a vehicle's operation and/or safety.
- Moderate: Moderate damage may affect multiple components of the vehicle and may impair the vehicle's operation and/or safety.
- Severe: Severe damage usually affects multiple components of the vehicle and is likely to compromise the vehicle's operation and/or safety.

CARFAX recommends getting a pre-purchase inspection at a certified collision repair facility.

First Owner

When the first owner(s) obtains a title from a Department of Motor Vehicles as proof of ownership.

Ownership History

CARFAX defines an owner as an individual or business that possesses and uses a vehicle. Not all title transactions represent changes in ownership. To provide estimated number of owners, CARFAX proprietary technology analyzes all the events in a vehicle history. Estimated ownership is available for vehicles manufactured after 1991 and titled solely in the US including Puerto Rico. Dealers sometimes opt to take ownership of a vehicle and are required to in the following states: Maine, Massachusetts, New Jersey, Ohio, Oklahoma, Pennsylvania and South Dakota. Please consider this as you review a vehicle's estimated ownership history.

Salvage Title

A Salvage Title is issued on a vehicle damaged to the extent that the cost of repairing the vehicle exceeds approximately 75% of its pre-damage value. This damage threshold may vary by state. Some states treat Junk titles the same as Salvage but the majority use this title to indicate that a vehicle is not road worthy and cannot be titled again in that state. The following eleven states also use Salvage titles to identify stolen vehicles - AZ, FL, GA, IL, MD, MN, NJ, NM, NY, OK and OR.

Title Issued

A state issues a title to provide a vehicle owner with proof of ownership. Each title has a unique number. Each title or registration record on a CARFAX report does not necessarily indicate a change in ownership. In Canada, a registration and bill of sale are used as proof of ownership.

Total Loss Vehicle

An insurance or fleet company declares a vehicle a total loss when a claim exceeds approximately 75% of its pre-damage value or if the vehicle is stolen and not recovered. This damage threshold varies by company. These companies typically take possession and obtain the title. Not all total loss vehicles result in a DMV-reported branded title. This may occur when an insurance company's definition of a total loss is different than the state DMV's definition for a branded title or when the owner of the vehicle is a self-insured company, like a fleet or rental company.

Follow Us:  facebook.com/CARFAX  [@CARFAXinc](https://twitter.com/CARFAXinc)  [About CARFAX](#)

CARFAX DEPENDS ON ITS SOURCES FOR THE ACCURACY AND RELIABILITY OF ITS INFORMATION. THEREFORE, NO RESPONSIBILITY IS ASSUMED BY CARFAX OR ITS AGENTS FOR ERRORS OR OMISSIONS IN THIS REPORT. CARFAX FURTHER EXPRESSLY DISCLAIMS ALL WARRANTIES, EXPRESS OR IMPLIED, INCLUDING ANY IMPLIED WARRANTIES OF MERCHANTABILITY OR FITNESS FOR A PARTICULAR PURPOSE.

© 2025 CARFAX, Inc., part of S&P Global. All rights reserved.
6/16/25 1:08:25 AM (CDT)

I have reviewed and received a copy of the CARFAX Vehicle History Report for this 2021 TESLA MODEL Y vehicle (VIN: 5YJYGDEE0MF204377), which is based on information supplied to CARFAX and available as of 6/16/25 at 2:08 AM (EDT).

Customer Signature

Date

Dealer Signature

Date