

**CARFAX** History-Based Value Report

[Hide](#)

**\$18,290**

CARFAX Retail Value

Retail  Wholesale

History events affecting this vehicle's value

- Personal Vehicle
- Salvage Brand

**CARFAX** Vehicle History Report™

US \$44.99

**2021 TESLA MODEL Y LONG RANGE**

VIN: 5YJYGDEE5MF137825  
4 DOOR WAGON/SPORT UTILITY  
ELECTRIC  
ALL WHEEL DRIVE

Branded Title: Salvage >

3 Service history records >

2 Previous owners >

Personal vehicle >

Last owned in Texas >

34,764 Last reported odometer reading >

CARFAX HAS THE MOST ACCIDENT & DAMAGE INFORMATION



This CARFAX Vehicle History Report is based only on [information](#) supplied to CARFAX and available as of 8/13/25 at 7:13:15 AM (CDT). Other information about this vehicle, including problems, may not have been reported to CARFAX. Use this report as one important tool, along with a vehicle inspection and test drive, to make a better decision about your next used car.

**CARFAX** Accident / Damage History

Not all accidents / issues are reported to CARFAX

Event 1

12/11/2024

**Accident reported: minor to moderate damage** ⓘ

[View More Details >](#)

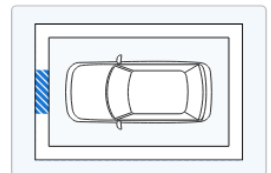
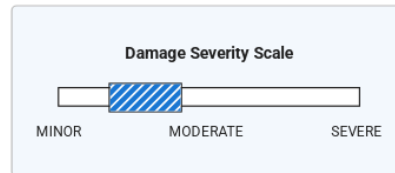

Event 2

07/31/2025

**TOTAL LOSS VEHICLE**

[View More Details >](#)

**CARFAX** Additional History

Not all accidents / issues are reported to CARFAX

Owner 1

Owner 2

**Total Loss** ⓘ

Total Loss Reported: 07/31/2025.

No Issues Reported

[Total Loss Reported](#)

Total Loss Reported: 07/31/2025.	<input checked="" type="checkbox"/> No Issues Reported	<a href="#">Total Loss Reported</a>
<b>Structural Damage</b> ⓘ CARFAX recommends that you have this vehicle inspected by a collision repair specialist.	<input checked="" type="checkbox"/> No Issues Reported	<input checked="" type="checkbox"/> No Issues Reported
<b>Airbag Deployment</b> ⓘ No airbag deployment reported to CARFAX.	<input checked="" type="checkbox"/> No Issues Reported	<input checked="" type="checkbox"/> No Issues Reported
<b>Odometer Check</b> ⓘ No indication of an odometer rollback.	<input checked="" type="checkbox"/> No Issues Indicated	<input checked="" type="checkbox"/> No Issues Indicated
<b>Accident / Damage</b> ⓘ DMV title problems reported. Accident reported: 12/11/2024.	<input checked="" type="checkbox"/> No Issues Reported	<a href="#">Severe Damage</a>
<b>Manufacturer Recall</b> ⓘ Check with an authorized Tesla dealer for any open recalls.	<b>Ask Your Dealer</b>	<b>Ask Your Dealer</b>
<b>Basic Warranty</b> ⓘ Original manufacturer warranty likely voided by manufacturer.	<input checked="" type="checkbox"/> Warranty Active	<b>Warranty Voided</b>

<b>CARFAX</b> Title History	Owner 1	Owner 2
<b>Damage Brands</b> ⓘ Salvage   Junk   Rebuilt   Fire   Flood   Hail   Lemon	No Problem	<b>Alert!</b> Problem Found
<b>Odometer Brands</b> ⓘ Not Actual Mileage   Exceeds Mechanical Limits	No Problem	No Problem
 <b>ALERT!</b> - Severe problems were reported by a state Department of Motor Vehicles (DMV). This vehicle does not qualify for the CARFAX Buyback Guarantee.		

<b>CARFAX</b> Ownership History	Owner 1	Owner 2
The number of owners is estimated		
Year purchased	2021	2022
Type of owner	Personal	Personal
Estimated length of ownership	1 yr. 1 mo.	3 yrs. 3 mo.
Owned in the following states/provinces	California	Texas, California
Estimated miles driven per year	11,607/yr	5,859/yr
Last reported odometer reading	12,593	34,764

**CARFAX** Detailed History [Glossary](#)

 <b>Owner 1</b> Purchased: 2021			Personal Vehicle 11,607 mi/yr
Date	Mileage	Source	Comments
03/02/2021	15	California Motor Vehicle Dept. San Jose, CA	<b>Odometer reading reported</b>

03/12/2021		California Motor Vehicle Dept. San Jose, CA		<b>Title issued or updated</b> - First owner reported - Titled or registered as personal vehicle - Loan or lien reported
04/12/2022	12,593	Vanguard Kia Arlington, TX 817-375-2700 vanguardkia.com ★ 4.6 / 5.0 <a href="#">924 Verified Reviews</a> ✓ ❤️ 10,413 Customer Favorites	🔧	<b>Vehicle serviced</b>

**Owner 2** Personal Vehicle  
Purchased: 2022 5,859 mi/yr

Date	Mileage	Source		Comments
04/20/2022		Texas Motor Vehicle Dept. Arlington, TX Title #22034144661145345		<b>Title issued or updated</b> - New owner reported - Loan or lien reported - Vehicle color noted as Black
03/11/2023	20,749	Vanguard Kia Arlington, TX 817-375-2700 vanguardkia.com ★ 4.6 / 5.0 <a href="#">924 Verified Reviews</a> ✓ ❤️ 10,413 Customer Favorites	🔧	<b>Vehicle serviced</b> - Maintenance inspection completed
04/01/2023		Texas Motor Vehicle Dept. Arlington, TX Title #22034144661145345		<b>Registration issued or renewed</b> - Loan or lien reported - Passed safety inspection - Vehicle color noted as Black
04/20/2023		California Motor Vehicle Dept. San Jose, CA		<b>Title issued or updated</b> - Loan or lien reported
02/29/2024	29,884	Vanguard Kia Arlington, TX 817-375-2700 vanguardkia.com ★ 4.6 / 5.0 <a href="#">924 Verified Reviews</a> ✓ ❤️ 10,413 Customer Favorites	🔧	<b>Vehicle serviced</b> - Maintenance inspection completed
04/01/2024		Texas Motor Vehicle Dept. Arlington, TX Title #22034144661145345		<b>Registration issued or renewed</b> - Loan or lien reported - Passed safety inspection - Vehicle color noted as Black
10/24/2024		California Motor Vehicle Dept. San Jose, CA		<b>Title issued or updated</b> - Loan or lien released

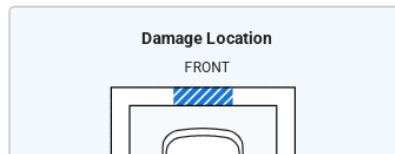
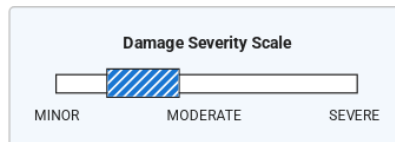

12/11/2024 **Damage Report**  **Accident reported: minor to moderate damage** ⓘ  
- Damage to front

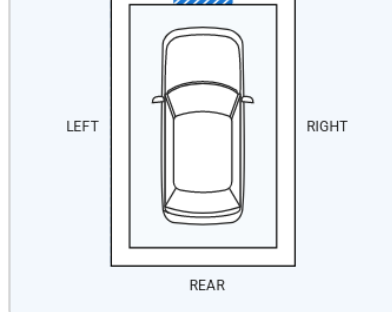

**CARFAX HAS THE MOST ACCIDENT & DAMAGE INFORMATION**

# CARFAX HAS THE MOST ACCIDENT & DAMAGE INFORMATION



01/03/2025		California Motor Vehicle Dept. Oklahoma City, OK		<b>Registration updated when owner moved the vehicle to a new location</b>
02/05/2025		California Motor Vehicle Dept. Oklahoma City, OK		<b>Title issued or updated</b> - Duplicate title issued
07/31/2025		Damage Report		<b>TOTAL LOSS VEHICLE</b>
			<div style="border: 1px solid #ccc; padding: 5px;"> <p>There are many reasons an insurance company will declare a vehicle a total loss. Have this vehicle inspected by a qualified technician before you buy. <a href="#">Learn More</a></p> </div>	
07/31/2025		Texas Motor Vehicle Dept.		<b>Title or registration issued to insurance company</b>
07/31/2025	34,764	Texas Motor Vehicle Dept. Fort Worth, TX Title #29758045865250016		<b>SALVAGE TITLE/CERTIFICATE ISSUED</b> - Vehicle color noted as Black

Have Questions? Consumers, please visit our Help Center at [www.carfax.com](http://www.carfax.com). Dealers or Subscribers, please visit our Help Center at [www.carfaxonline.com](http://www.carfaxonline.com).

## CARFAX Glossary

[Full Glossary](#)

### Accident Indicator

CARFAX receives information about accidents in all 50 states, the District of Columbia and Canada.

Not every accident is reported to CARFAX. As details about the accident become available, those additional details are added to the CARFAX Vehicle History Report. CARFAX recommends that you have this vehicle inspected by a qualified mechanic.

- According to the National Safety Council, Injury Facts, 2021 edition, 5% of the 276 million registered vehicles in the U.S. were involved in an accident in 2019. Over 77% of these were considered minor or moderate.
- This CARFAX Vehicle History Report is based only on information supplied to CARFAX and available as of 8/13/25 at 7:13:15 AM (CDT). Other information about this vehicle, including problems, may not have been reported to CARFAX. Use this report as one important tool, along with a vehicle inspection and test drive, to make a better decision about your next used car.

### Damage Indicator

Damage can be a result of many different types of events. Examples include contact with objects (other cars, trees, traffic signs, road debris, etc), vandalism, or weather-related events. Not every damage event is reported to CARFAX. As details about the damage event become available, those additional details are added to the CARFAX Vehicle History Report. CARFAX recommends that you have this vehicle inspected by a qualified mechanic.

- This CARFAX Vehicle History Report is based only on information supplied to CARFAX and available as of 8/13/25 at 7:13:15 AM (CDT). Other information about this vehicle, including problems, may not have been reported to CARFAX. Use this report as one important tool, along with a vehicle inspection and test drive, to make a better decision about your next used car.

### Damage Severity

Damage events result in one of the following severity levels:

- Minor: Generally, minor damage is cosmetic (including dents or scratches), may only require reconditioning, and typically does not compromise a vehicle's operation and/or safety.
- Moderate: Moderate damage may affect multiple components of the vehicle and may impair the vehicle's operation and/or safety.
- Severe: Severe damage usually affects multiple components of the vehicle and is likely to compromise the vehicle's operation and/or safety.

CARFAX recommends getting a pre-purchase inspection at a certified collision repair facility.

### First Owner

**First Owner**

When the first owner(s) obtains a title from a Department of Motor Vehicles as proof of ownership.

**New Owner Reported**

When a vehicle is sold to a new owner, the Title must be transferred to the new owner(s) at a Department of Motor Vehicles.

**Ownership History**

CARFAX defines an owner as an individual or business that possesses and uses a vehicle. Not all title transactions represent changes in ownership. To provide estimated number of owners, CARFAX proprietary technology analyzes all the events in a vehicle history. Estimated ownership is available for vehicles manufactured after 1991 and titled solely in the US including Puerto Rico. Dealers sometimes opt to take ownership of a vehicle and are required to in the following states: Maine, Massachusetts, New Jersey, Ohio, Oklahoma, Pennsylvania and South Dakota. Please consider this as you review a vehicle's estimated ownership history.

**Salvage Title**

A Salvage Title is issued on a vehicle damaged to the extent that the cost of repairing the vehicle exceeds approximately 75% of its pre-damage value. This damage threshold may vary by state. Some states treat Junk titles the same as Salvage but the majority use this title to indicate that a vehicle is not road worthy and cannot be titled again in that state. The following eleven states also use Salvage titles to identify stolen vehicles - AZ, FL, GA, IL, MD, MN, NJ, NM, NY, OK and OR.

**Title Issued**

A state issues a title to provide a vehicle owner with proof of ownership. Each title has a unique number. Each title or registration record on a CARFAX report does not necessarily indicate a change in ownership. In Canada, a registration and bill of sale are used as proof of ownership.

**Total Loss Vehicle**

An insurance or fleet company declares a vehicle a total loss when a claim exceeds approximately 75% of its pre-damage value or if the vehicle is stolen and not recovered. This damage threshold varies by company. These companies typically take possession and obtain the title. Not all total loss vehicles result in a DMV-reported branded title. This may occur when an insurance company's definition of a total loss is different than the state DMV's definition for a branded title or when the owner of the vehicle is a self-insured company, like a fleet or rental company.

Follow Us:  [facebook.com/CARFAX](https://facebook.com/CARFAX)  [@CARFAXinc](https://twitter.com/CARFAXinc)  [About CARFAX](#)

CARFAX DEPENDS ON ITS SOURCES FOR THE ACCURACY AND RELIABILITY OF ITS INFORMATION. THEREFORE, NO RESPONSIBILITY IS ASSUMED BY CARFAX OR ITS AGENTS FOR ERRORS OR OMISSIONS IN THIS REPORT. CARFAX FURTHER EXPRESSLY DISCLAIMS ALL WARRANTIES, EXPRESS OR IMPLIED, INCLUDING ANY IMPLIED WARRANTIES OF MERCHANTABILITY OR FITNESS FOR A PARTICULAR PURPOSE.

© 2025 CARFAX, Inc., part of S&P Global. All rights reserved.  
8/13/25 7:13:15 AM (CDT)

**I have reviewed and received a copy of the CARFAX Vehicle History Report for this 2021 TESLA MODEL Y vehicle (VIN: 5YJYGDEE5MF137825), which is based on information supplied to CARFAX and available as of 8/13/25 at 8:13 AM (EDT).**

\_\_\_\_\_  
Customer Signature

\_\_\_\_\_  
Date

\_\_\_\_\_  
Dealer Signature

\_\_\_\_\_  
Date