

CARFAX History-Based Value Report [Hide](#)

\$27,400

CARFAX Retail Value

Retail Wholesale

History events affecting this vehicle's value

- 1-Owner Vehicle
- Personal Vehicle
- Salvage Brand

CARFAX Vehicle History Report™ US \$44.99

2023 TESLA MODEL Y LONG RANGE

VIN: 7SAYGDEE2PF674286
4 DOOR WAGON/SPORT UTILITY
ELECTRIC
ALL WHEEL DRIVE

Branded Title: Salvage >

2 Service history records >

CARFAX 1-Owner vehicle >

Personal vehicle >

Last owned in North Carolina >

32,913 Last reported odometer reading >

CARFAX HAS THE MOST ACCIDENT & DAMAGE INFORMATION



This CARFAX Vehicle History Report is based only on [information](#) supplied to CARFAX and available as of 5/15/25 at 11:47:12 AM (CDT). Other information about this vehicle, including problems, may not have been reported to CARFAX. Use this report as one important tool, along with a vehicle inspection and test drive, to make a better decision about your next used car.

CARFAX Accident / Damage History

Not all accidents / issues are reported to CARFAX

Event 1

03/23/2025

Accident reported: minor to moderate damage

- Involving front or side impact
- Vehicle disabled
- Vehicle towed
- Airbags did not deploy

[View More Details >](#)

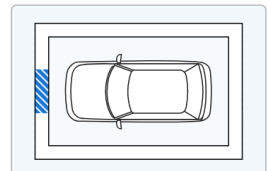
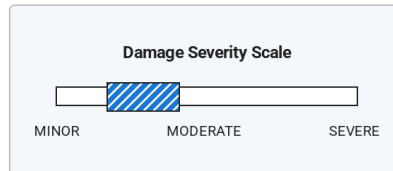

Event 2

03/24/2025

Accident reported: minor to moderate damage

- It hit a stationary object
- Vehicle drivable
- Airbags did not deploy

[View More Details >](#)

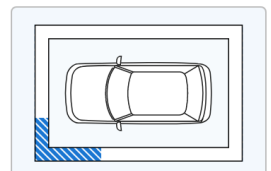
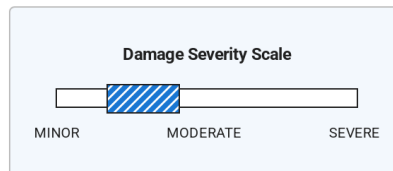



Additional History

Not all accidents / issues are reported to CARFAX

Owner 1

Total Loss ⓘ

No total loss reported to CARFAX.

✔ No Issues Reported

Structural Damage ⓘ

CARFAX recommends that you have this vehicle inspected by a collision repair specialist.

✔ No Issues Reported

Airbag Deployment ⓘ

No airbag deployment reported to CARFAX.

✔ No Issues Reported

Odometer Check ⓘ

No indication of an odometer rollback.

✔ No Issues Indicated

Accident / Damage ⓘ

DMV title problems reported. Accidents reported: 03/23/2025 and 03/24/2025.

[Severe Damage](#)

Manufacturer Recall ⓘ

Check with an authorized Tesla dealer for any open recalls.

Ask Your Dealer

Basic Warranty ⓘ

Original manufacturer warranty likely voided by manufacturer.

Warranty Voided



Title History

Owner 1

Damage Brands ⓘ

Salvage | Junk | Rebuilt | Fire | Flood | Hail | Lemon

Alert!
Problem Found

Odometer Brands ⓘ

Not Actual Mileage | Exceeds Mechanical Limits

No Problem



ALERT! - Severe problems were reported by a state Department of Motor Vehicles (DMV). This vehicle does not qualify for the CARFAX Buyback Guarantee.



Ownership History

The number of owners is estimated

Owner 1

Year purchased

2023

Type of owner

Personal

Estimated length of ownership

2 yrs. 2 mo.

Owned in the following states/provinces

North Carolina

Estimated miles driven per year

16,631/yr

Last reported odometer reading

32,913



Detailed History

[Glossary](#)







Owner 1

Purchased: 2023

Personal Vehicle

16,631 mi/yr

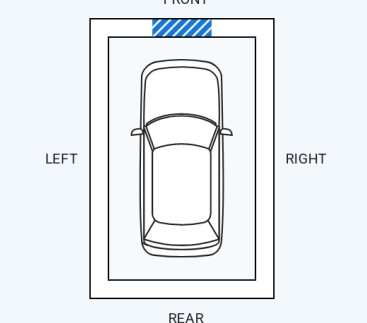
Date	Mileage	Source	Comments
02/21/2023	15	North Carolina Motor Vehicle Dept. Waxhaw, NC	Odometer reading reported - Titled or registered as personal vehicle
03/09/2023		North Carolina Motor Vehicle Dept. Waxhaw, NC Title #770386230684179	Registration issued or renewed - Title or registration issued - First owner reported
02/09/2024	14,034	Valvoline Instant Oil Change Waxhaw, NC 704-399-0999 https://valvoline.com ★ 4.7 / 5.0 165 Verified Reviews ✓ ♥ 1 Customer Favorite	 Vehicle serviced - Safety inspection performed
02/09/2024		North Carolina Motor Vehicle Dept. Waxhaw, NC Title #770386230684179	Registration issued or renewed
02/12/2025	32,913	Valvoline Instant Oil Change Waxhaw, NC 704-399-0999 https://valvoline.com ★ 4.7 / 5.0 165 Verified Reviews ✓ ♥ 1 Customer Favorite	 Vehicle serviced - Brakes checked - Safety inspection performed
02/13/2025		North Carolina Motor Vehicle Dept. Waxhaw, NC Title #770386230684179	Registration issued or renewed
03/23/2025		Damage Report	 Accident reported: minor to moderate damage ⓘ - Involving front or side impact - Damage to front - Vehicle disabled - Vehicle towed - Airbags did not deploy <div data-bbox="847 1413 1246 1554"> <p>Damage Severity Scale</p>  </div> <div data-bbox="847 1570 1246 1973"> <p>Damage Location</p>  </div>

CARFAX HAS THE MOST ACCIDENT & DAMAGE INFORMATION

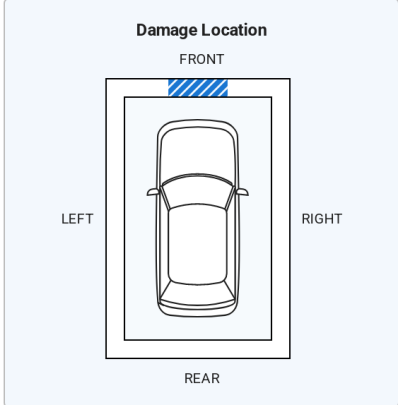
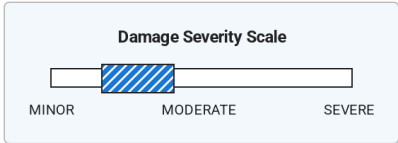

03/24/2025		Damage Report	 Accident reported: minor to moderate damage ⓘ - It hit a stationary object - Damage to left front - Vehicle drivable - Airbags did not deploy <div data-bbox="847 2197 1246 2240"> <p>Damage Severity Scale</p> </div>
------------	--	---------------	---

CARFAX HAS THE MOST ACCIDENT & DAMAGE INFORMATION

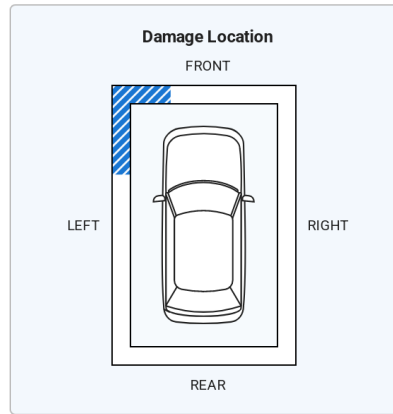
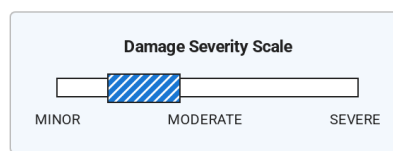

05/09/2025

Damage Report



SALVAGE TITLE/CERTIFICATE ISSUED

Have Questions? Consumers, please visit our Help Center at www.carfax.com. Dealers or Subscribers, please visit our Help Center at www.carfaxonline.com.

Accident Indicator

CARFAX receives information about accidents in all 50 states, the District of Columbia and Canada.

Not every accident is reported to CARFAX. As details about the accident become available, those additional details are added to the CARFAX Vehicle History Report. CARFAX recommends that you have this vehicle inspected by a qualified mechanic.

- According to the National Safety Council, Injury Facts, 2021 edition, 5% of the 276 million registered vehicles in the U.S. were involved in an accident in 2019. Over 77% of these were considered minor or moderate.
- This CARFAX Vehicle History Report is based only on information supplied to CARFAX and available as of 5/15/25 at 11:47:12 AM (CDT). Other information about this vehicle, including problems, may not have been reported to CARFAX. Use this report as one important tool, along with a vehicle inspection and test drive, to make a better decision about your next used car.

Damage Indicator

Damage can be a result of many different types of events. Examples include contact with objects (other cars, trees, traffic signs, road debris, etc), vandalism, or weather-related events. Not every damage event is reported to CARFAX. As details about the damage event become available, those additional details are added to the CARFAX Vehicle History Report. CARFAX recommends that you have this vehicle inspected by a qualified mechanic.

- This CARFAX Vehicle History Report is based only on information supplied to CARFAX and available as of 5/15/25 at 11:47:12 AM (CDT). Other information about this vehicle, including problems, may not have been reported to CARFAX. Use this report as one important tool, along with a vehicle inspection and test drive, to make a better decision about your next used car.

Damage Severity

Damage events result in one of the following severity levels:

- Minor: Generally, minor damage is cosmetic (including dents or scratches), may only require reconditioning, and typically does not compromise a vehicle's operation and/or safety.
- Moderate: Moderate damage may affect multiple components of the vehicle and may impair the vehicle's operation and/or safety.
- Severe: Severe damage usually affects multiple components of the vehicle and is likely to compromise the vehicle's operation and/or safety.

CARFAX recommends getting a pre-purchase inspection at a certified collision repair facility.

First Owner

When the first owner(s) obtains a title from a Department of Motor Vehicles as proof of ownership.



Ownership History

CARFAX defines an owner as an individual or business that possesses and uses a vehicle. Not all title transactions represent changes in ownership. To provide estimated number of owners, CARFAX proprietary technology analyzes all the events in a vehicle history. Estimated ownership is available for vehicles manufactured after 1991 and titled solely in the US including Puerto Rico. Dealers sometimes opt to take ownership of a vehicle and are required to in the following states: Maine, Massachusetts, New Jersey, Ohio, Oklahoma, Pennsylvania and South Dakota. Please consider this as you review a vehicle's estimated ownership history.

Salvage Title

A Salvage Title is issued on a vehicle damaged to the extent that the cost of repairing the vehicle exceeds approximately 75% of its pre-damage value. This damage threshold may vary by state. Some states treat Junk titles the same as Salvage but the majority use this title to indicate that a vehicle is not road worthy and cannot be titled again in that state. The following eleven states also use Salvage titles to identify stolen vehicles - AZ, FL, GA, IL, MD, MN, NJ, NM, NY, OK and OR.

itled again in that state. The following eleven states also use salvage titles to identify stolen vehicles - AZ, FL, GA, IL, MD, MN, NJ, NV, NY, OR and OK.

Follow Us:  facebook.com/CARFAX  [@CARFAXinc](https://twitter.com/CARFAXinc)  [About CARFAX](#)

CARFAX DEPENDS ON ITS SOURCES FOR THE ACCURACY AND RELIABILITY OF ITS INFORMATION. THEREFORE, NO RESPONSIBILITY IS ASSUMED BY CARFAX OR ITS AGENTS FOR ERRORS OR OMISSIONS IN THIS REPORT. CARFAX FURTHER EXPRESSLY DISCLAIMS ALL WARRANTIES, EXPRESS OR IMPLIED, INCLUDING ANY IMPLIED WARRANTIES OF MERCHANTABILITY OR FITNESS FOR A PARTICULAR PURPOSE.

© 2025 CARFAX, Inc., part of S&P Global. All rights reserved.
5/15/25 11:47:12 AM (CDT)

I have reviewed and received a copy of the CARFAX Vehicle History Report for this 2023 TESLA MODEL Y vehicle (VIN: 7SAYGDEE2PF674286), which is based on information supplied to CARFAX and available as of 5/15/25 at 12:47 PM (EDT).

Customer Signature

Date

Dealer Signature

Date