

CARFAX History-Based Value Report

\$10,730

CARFAX Retail Value

History events affecting this vehicle's value

- Service History
- Personal Vehicle
- Damage Brand
- Exceeds Mechanical Limits

CARFAX Vehicle History Report™

US \$44.99

2021 MAZDA CX-3 SPORT

VIN: JM1DKDB7XM1513656
 WAGON 4 DR
 2.0L I4 F DOHC 16V
 GASOLINE
 FRONT WHEEL DRIVE

Branded Titles: Exceeds Mechanical Limits, Rebuilt, Salvage >

7 Service history records >

3 Previous owners >

Personal vehicle >

Last owned in Texas >

23 Detailed records available >

This CARFAX Vehicle History Report is based only on [information](#) supplied to CARFAX and available as of 1/13/26 at 1:11:33 AM (CST). Other information about this vehicle, including problems, may not have been reported to CARFAX. Use this report as one important tool, along with a vehicle inspection and test drive, to make a better decision about your next used car.

CARFAX Accident / Damage History

Not all accidents / issues are reported to CARFAX

Event 1

01/10/2024

Accident reported: minor to moderate damage ⓘ

- Involving front or side impact with another motor vehicle
- Disabling damage reported
- Vehicle disabled
- Vehicle towed

[View More Details >](#)

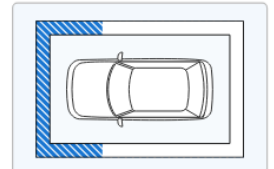
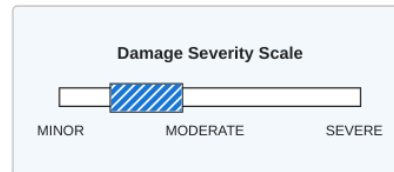

Event 2

01/10/2024

TOTAL LOSS VEHICLE

- Vehicle declared a total loss by an insurance company
- Collision damage reported

[View More Details >](#)

[View More Details >](#)

Event 3

09/11/2024

Accident reported: minor to moderate damage ⓘ

- Involving front or side impact
- Airbags did not deploy

[View More Details >](#)

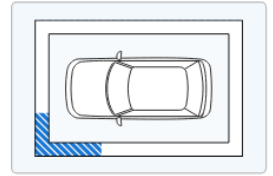
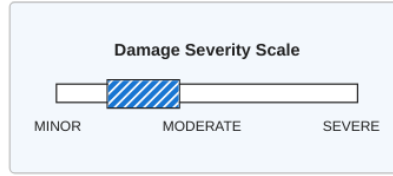

CARFAX Recent Service Highlights

Key services performed in the last 12 months

Service	Comments	Date	
Oil	✓ Oil and filter changed	10/27/2025	View Details >
 <div style="border: 1px solid #ccc; padding: 5px; display: inline-block;">This car has been recently serviced. That's a good thing!</div>			

CARFAX Additional History

Not all accidents / issues are reported to CARFAX

	Owner 1	Owner 2	Owner 3
Total Loss ⓘ Total Loss Reported: 01/10/2024.	Total Loss Reported	No New Issues Reported	No New Issues Reported
Structural Damage ⓘ CARFAX recommends that you have this vehicle inspected by a collision repair specialist.	✓ No Issues Reported	✓ No Issues Reported	✓ No Issues Reported
Airbag Deployment ⓘ No airbag deployment reported to CARFAX.	✓ No Issues Reported	✓ No Issues Reported	✓ No Issues Reported
Odometer Check ⓘ DMV title problems reported.	✓ No Issues Indicated	✓ No Issues Indicated	Odometer Problem
Accident / Damage ⓘ DMV title problems reported. Accidents reported: 01/10/2024 and 09/11/2024.	Severe Damage	Severe Damage	Severe Damage
Manufacturer Recall ⓘ No open recalls reported to CARFAX.	✓ No Recalls Reported	✓ No Recalls Reported	✓ No Recalls Reported
Basic Warranty ⓘ Original manufacturer warranty likely voided by manufacturer.	Warranty Voided	Warranty Voided	Warranty Voided

CARFAX Title History

	Owner 1	Owner 2	Owner 3
Damage Brands ⓘ Salvage Junk Rebuilt Fire Flood Hail Lemon	Alert! Problem Found	Alert! Problem Found	Alert! Problem Found
Odometer Brands ⓘ Not Actual Mileage Exceeds Mechanical Limits	No Problem	No Problem	Alert! Problem Found

 **ALERT!** - Severe problems were reported by a state Department of Motor Vehicles (DMV). This vehicle does not qualify for the CARFAX Buyback Guarantee.



Ownership History

The number of owners is estimated

	Owner 1	Owner 2	Owner 3
Year purchased	2021	2024	2025
Type of owner	Personal	Personal	Personal
Estimated length of ownership	2 yrs. 9 mo.	9 months	4 months
Owned in the following states/provinces	Louisiana, Texas	Texas	Texas
Estimated miles driven per year	13,395/yr	---	---
Last reported odometer reading	47,777	47,831	57,814



Detailed History

[Glossary](#)

Owner 1

Purchased: 2021

Personal Vehicle





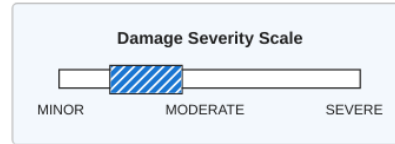

13,395 mi/yr

Date	Mileage	Source		Comments
04/09/2021		Mazda Motor of America, Inc.		Vehicle manufactured and shipped to original dealer
05/10/2021		Louisiana Motor Vehicle Dept.		Vehicle purchase reported - Titled or registered as personal vehicle
06/05/2021	7	Louisiana Motor Vehicle Dept. Homer, LA		Title issued or updated - First owner reported - Loan or lien reported - Vehicle color noted as Gray
10/20/2021	7,338	Brown Service Center Minden, LA 318-390-1520 https://sites.google.com/view/brownservicecenter		Vehicle serviced - Oil and filter changed
04/21/2022	14,682	Brown Service Center Minden, LA 318-390-1520 https://sites.google.com/view/brownservicecenter		Vehicle serviced - Oil and filter changed
11/17/2022	21,851	Brown Service Center Minden, LA 318-390-1520 https://sites.google.com/view/brownservicecenter		Vehicle serviced - Oil and filter changed
02/23/2023		Louisiana Motor Vehicle Dept. Homer, LA		Registration issued or renewed - Loan or lien reported - Vehicle color noted as Gray
05/26/2023	29,707	Brown Service Center Minden, LA 318-390-1520 https://sites.google.com/view/brownservicecenter		Vehicle serviced - Oil and filter changed
01/10/2024		Damage Report		Accident reported: minor to moderate damage - Involving front or side impact with another motor vehicle - Damage to front - Damage to left front - Damage to right front

- Damage to left front
- Damage to right front
- Disabling damage reported
- Vehicle disabled
- Vehicle towed

CARFAX HAS THE MOST ACCIDENT & DAMAGE INFORMATION



01/10/2024		Damage Report	 TOTAL LOSS VEHICLE - Vehicle declared a total loss by an insurance company - Collision damage reported
			There are many reasons an insurance company will declare a vehicle a total loss. Have this vehicle inspected by a qualified technician before you buy. Learn More
02/14/2024		Louisiana Motor Vehicle Dept.	Vehicle purchase reported
02/15/2024		Louisiana Motor Vehicle Dept.	Title or registration issued to insurance company
02/15/2024	37,104	Louisiana Motor Vehicle Dept. Columbia, MO	 Dealer took title of this vehicle while it was in inventory - SALVAGE TITLE/CERTIFICATE ISSUED - Vehicle color noted as Gray
02/29/2024		Auto Auction	Vehicle sold
03/29/2024	37,129	Take 5 Oil Change Murphy, TX 504-837-0674 take5.com/oil-change/  2 Customer Favorites	 Vehicle serviced - Oil and filter changed
04/30/2024		Texas Motor Vehicle Dept. Mesquite, TX Title #05748645402105738	 Dealer took title of this vehicle while it was in inventory - SALVAGE TITLE/CERTIFICATE ISSUED - REBUILT TITLE ISSUED - Vehicle color noted as Gray

09/11/2024		Damage Report	 Accident reported: minor to moderate damage ⓘ - Involving front or side impact - Damage to left front - Airbags did not deploy
------------	--	---------------	--

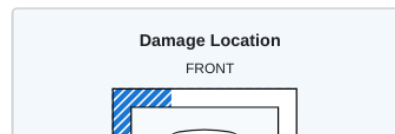
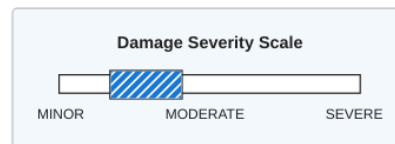

CARFAX HAS THE MOST ACCIDENT & DAMAGE INFORMATION

CARFAX HAS THE MOST ACCIDENT & DAMAGE INFORMATION

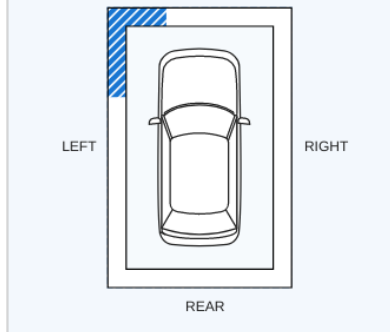

11/04/2024 47,777 Texas Inspection Station Allen, TX **Passed emissions inspection**

Owner 2 Personal Vehicle
Purchased: 2024

Date	Mileage	Source	Comments
11/14/2024		Texas Motor Vehicle Dept. Allen, TX Title #05749845600132122	New owner reported - SALVAGE TITLE/CERTIFICATE ISSUED - REBUILT TITLE ISSUED - Vehicle color noted as Gray
05/26/2025	47,831	Walmart Auto Care Center Plano, TX 972-422-1888 https://www.walmart.com 2 Customer Favorites	Vehicle serviced - Oil and filter changed

Owner 3 Personal Vehicle
Purchased: 2025

Date	Mileage	Source	Comments
09/13/2025	45,000	Texas Motor Vehicle Dept. Plano, TX Title #04333845903115817	New owner reported - SALVAGE TITLE/CERTIFICATE ISSUED - EXCEEDS MECHANICAL LIMITS TITLE ISSUED - REBUILT TITLE ISSUED - Vehicle color noted as Gray
			An EML title is issued when the owner discloses an odometer rollover to a DMV. Rollovers occur on vehicles with 5-digit odometers that go from 99,999 to 00,000 every 100,000 miles. Mileage reported after this reading is potentially unreliable.
10/08/2025		Texas Motor Vehicle Dept. Plano, TX Title #04333745928134404	SALVAGE TITLE/CERTIFICATE ISSUED - EXCEEDS MECHANICAL LIMITS TITLE ISSUED - REBUILT TITLE ISSUED - Loan or lien reported - Vehicle color noted as Gray
			Avoid financial headaches. Make sure the loan has been paid off if you're buying from a private seller. Learn More
10/27/2025	57,814	Walmart Auto Care Center Dallas, TX 972-233-8567 https://www.walmart.com 2 Customer Favorites	Vehicle serviced - Oil and filter changed

Have Questions? Consumers, please visit our Help Center at www.carfax.com. Dealers or Subscribers, please visit our Help Center at www.carfaxonline.com.

Accident Indicator

CARFAX receives information about accidents in all 50 states, the District of Columbia and Canada.

Not every accident is reported to CARFAX. As details about the accident become available, those additional details are added to the CARFAX Vehicle History Report. CARFAX recommends that you have this vehicle inspected by a qualified mechanic.

- According to the National Safety Council, Injury Facts, 2021 edition, 5% of the 276 million registered vehicles in the U.S. were involved in an accident in 2019. Over 77% of these were considered minor or moderate.
- This CARFAX Vehicle History Report is based only on information supplied to CARFAX and available as of 1/13/26 at 1:11:33 AM (CST). Other information about this vehicle, including problems, may not have been reported to CARFAX. Use this report as one important tool, along with a vehicle inspection and test drive, to make a better decision about your next used car.

Damage Indicator

Damage can be a result of many different types of events. Examples include contact with objects (other cars, trees, traffic signs, road debris, etc), vandalism, or weather-related events. Not every damage event is reported to CARFAX. As details about the damage event become available, those additional details are added to the CARFAX Vehicle History Report. CARFAX recommends that you have this vehicle inspected by a qualified mechanic.

- This CARFAX Vehicle History Report is based only on information supplied to CARFAX and available as of 1/13/26 at 1:11:33 AM (CST). Other information about this vehicle, including problems, may not have been reported to CARFAX. Use this report as one important tool, along with a vehicle inspection and test drive, to make a better decision about your next used car.

Damage Severity

Damage events result in one of the following severity levels:

- Minor: Generally, minor damage is cosmetic (including dents or scratches), may only require reconditioning, and typically does not compromise a vehicle's operation and/or safety.
- Moderate: Moderate damage may affect multiple components of the vehicle and may impair the vehicle's operation and/or safety.
- Severe: Severe damage usually affects multiple components of the vehicle and is likely to compromise the vehicle's operation and/or safety.

CARFAX recommends getting a pre-purchase inspection at a certified collision repair facility.

Exceeds Mechanical Limits

A vehicle with a 5-digit odometer cannot accurately track mileage after 99,999 miles because the odometer rolls over. This title is the result of a seller certifying under the Federal Odometer Act, that the odometer reading EXCEEDS MECHANICAL LIMITS of the odometer.

Federal Odometer Act

The Federal Odometer Act requires a seller to disclose the vehicle's mileage on the title when ownership is transferred. Congress enacted this Act to prohibit odometer tampering and to protect consumers from mileage fraud. Under this act, sellers must disclose any issues with the vehicle's odometer. These disclosures translate into the Exceed Mechanical Limits and Not Actual Mileage titles.

First Owner

When the first owner(s) obtains a title from a Department of Motor Vehicles as proof of ownership.

New Owner Reported

When a vehicle is sold to a new owner, the Title must be transferred to the new owner(s) at a Department of Motor Vehicles.

Ownership History

CARFAX defines an owner as an individual or business that possesses and uses a vehicle. Not all title transactions represent changes in ownership. To provide estimated number of owners, CARFAX proprietary technology analyzes all the events in a vehicle history. Estimated ownership is available for vehicles manufactured after 1991 and titled solely in the US including Puerto Rico. Dealers sometimes opt to take ownership of a vehicle and are required to in the following states: Maine, Massachusetts, New Jersey, Ohio, Oklahoma, Pennsylvania and South Dakota. Please consider this as you review a vehicle's estimated ownership history.

Rebuilt/Reconstructed Title

A Rebuilt/Reconstructed vehicle is a salvage vehicle that has been repaired and restored to operation. These vehicles are often severely damaged before they are rebuilt and refurbished parts are typically used during reconstruction. In most states, an inspection of the vehicle is required before the vehicle is allowed to return to the road.

Salvage Title

A Salvage Title is issued on a vehicle damaged to the extent that the cost of repairing the vehicle exceeds approximately 75% of its pre-damage value. This damage threshold may vary by state. Some states treat Junk titles the same as Salvage but the majority use this title to indicate that a vehicle is not road worthy and cannot be titled again in that state. The following eleven states also use Salvage titles to identify stolen vehicles - AZ, FL, GA, IL, MD, MN, NJ, NM, NY, OK and OR.

Title Issued

A state issues a title to provide a vehicle owner with proof of ownership. Each title has a unique number. Each title or registration record on a CARFAX report does not necessarily indicate a change in ownership. In Canada, a registration and bill of sale are used as proof of ownership.

Total Loss Vehicle

An insurance or fleet company declares a vehicle a total loss when a claim exceeds approximately 75% of its pre-damage value or if the vehicle is stolen and not recovered. This damage threshold varies by company. These companies typically take possession and obtain the title. Not all total loss vehicles result in a DMV-reported branded title. This may occur when an insurance company's definition of a total loss is different than the state DMV's definition for a branded title or when the owner of the vehicle is a self-insured company, like a fleet or rental company.

Follow
Us:



facebook.com/CARFAX



[@CARFAXinc](https://twitter.com/CARFAXinc)



[About CARFAX](#)

CARFAX DEPENDS ON ITS SOURCES FOR THE ACCURACY AND RELIABILITY OF ITS INFORMATION. THEREFORE, NO RESPONSIBILITY IS ASSUMED BY CARFAX OR ITS AGENTS FOR ERRORS OR OMISSIONS IN THIS REPORT. CARFAX FURTHER EXPRESSLY DISCLAIMS ALL WARRANTIES, EXPRESS OR IMPLIED, INCLUDING ANY IMPLIED WARRANTIES OF MERCHANTABILITY OR FITNESS FOR A PARTICULAR PURPOSE.

© 2026 CARFAX, Inc., part of S&P Global. All rights reserved.
1/13/26 1:11:33 AM (CST)

I have reviewed and received a copy of the CARFAX Vehicle History Report for this 2021 MAZDA CX-3 vehicle (VIN: JM1DKDB7XM1513656), which is based on information supplied to CARFAX and available as of 1/13/26 at 2:11 AM (EST).

Customer Signature

Date

Dealer Signature

Date