

### 2018 Mazda Mazda6 Signature

VIN: JM1GL1XY2J1320052

[Vehicle Details](#) ▾

CARFAX HAS THE MOST ACCIDENT & DAMAGE INFORMATION



**BRANDED TITLE**

Not Actual Mileage, Salvage

**CARFAX VALUE** \$11,200

[Update Trim & Options](#)

**11 Service History Records**

**3 Previous Owners**

**Personal Vehicle**

**Last Owned in Georgia**

**34 Detailed Records Available**

This CARFAX Vehicle History Report is based only on [information](#) supplied to CARFAX and available as of 4/23/26 at 8:46:01 AM (CDT). Other information about this vehicle, including problems, may not have been reported to CARFAX. Use this report as one important tool, along with a vehicle inspection and test drive, to make a better decision about your next used car.

### Accident / Damage History

Not all accidents / issues are reported to CARFAX

#### Event 1

10/17/2019

**Damage reported: minor damage** ⓘ

[View More Details](#) >

#### Damage Severity Scale



Minor

Moderate

Severe

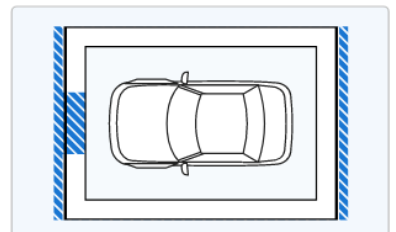

Event 2

06/27/2023

Accident reported: minor damage ⓘ

-Airbags did not deploy

[View More Details >](#)

Damage Severity Scale

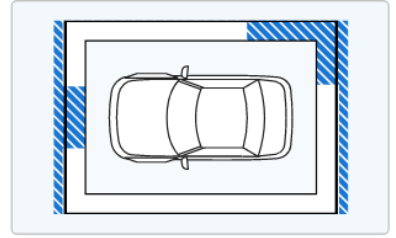
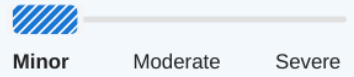

Event 3

12/31/2025

Accident reported: moderate damage ⓘ

-Airbag deployed

[View More Details >](#)

Damage Severity Scale

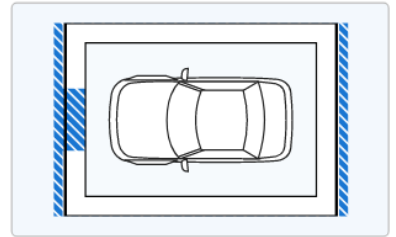

[Show More >](#)

**CARFAX** Recent Service Highlights

Key services performed in the last 12 months

Service	Comments	Date	
Oil	✓ Oil and filter changed	07/07/2025	<a href="#">View Details &gt;</a>
 <div style="border: 1px solid #ccc; padding: 5px; display: inline-block;">This car has been recently serviced. That's a good thing!</div>			

**CARFAX** History-Based Value Report

**\$11,200**

CARFAX Retail Value

History events affecting this vehicle's value

- Service History
- Personal Vehicle
- Salvage Brand
- Not Actual Mileage

<b>CARFAX</b> Additional History Not all accidents / issues are reported to CARFAX	Owner 1	Owner 2	Owner 3
<b>Total Loss</b> ⓘ Total Loss Reported: 04/07/2026.	✓	✓	<a href="#">Total Loss Reported</a>
<b>Structural Damage</b> ⓘ CARFAX recommends that you have this vehicle inspected by a collision repair specialist.	✓	✓	✓
<b>Airbag Deployment</b> ⓘ Airbag deployment reported: 12/31/2025.	✓	✓	<a href="#">Airbag Deployment</a>
<b>Odometer Check</b> ⓘ DMV title problems reported.	✓	✓	<a href="#">Odometer Problem</a>
<b>Accident / Damage</b> ⓘ DMV title problems reported. Damage reported: 10/17/2019. Accidents reported: 06/27/2023 and 12/31/2025.	<a href="#">Damage Reported</a>	No New Issues Reported	<a href="#">Severe Damage</a>
<b>Manufacturer Recall</b> ⓘ No open recalls reported to CARFAX.	No Recalls Reported	No Recalls Reported	No Recalls Reported
<b>Basic Warranty</b> ⓘ Original manufacturer warranty likely voided by manufacturer.	✓	✓	<b>Warranty Voided</b>

<b>CARFAX</b> Title History	Owner 1	Owner 2	Owner 3
<b>Damage Brands</b> ⓘ Salvage   Junk   Rebuilt   Fire   Flood   Hail   Lemon	No Problem	No Problem	<b>Alert!</b> Problem Found
<b>Odometer Brands</b> ⓘ Not Actual Mileage   Exceeds Mechanical Limits	No Problem	No Problem	<b>Alert!</b> Problem Found

 **ALERT!** - Severe problems were reported by a state Department of Motor Vehicles (DMV). This vehicle does not qualify for the CARFAX Buyback Guarantee.

<b>CARFAX</b> Ownership History The number of owners is estimated	Owner 1	Owner 2	Owner 3
Year purchased	2018	2022	2022
Type of owner	Personal	Personal	Personal
Estimated length of ownership	3 yrs. 3 mo.	1 month	3 yrs. 10 mo.
Owned in the following states/provinces	Georgia	Georgia	Georgia
Estimated miles driven per year	15,464/yr	---	---
Last reported odometer reading	53,498	55,421	114,000

**Owner 1**  
Purchased: 2018

Personal Vehicle  
15,464 mi/yr

Date	Mileage	Source	Comments
07/23/2018		NICB	<b>Vehicle manufactured and shipped to Georgia</b>
07/27/2018		Georgia Motor Vehicle Dept.	<b>Vehicle purchase reported</b> - Titled or registered as personal vehicle
08/23/2018	16	Georgia Motor Vehicle Dept. Bishop, GA Title #771719182352965	<b>Vehicle purchase reported</b> - Title issued or updated - Registration issued or renewed - Title or registration issued - First owner reported - Vehicle color noted as Red
10/02/2019		Georgia Motor Vehicle Dept. Bishop, GA Title #771719182352965	<b>Registration issued or renewed</b> - Vehicle color noted as Red
10/17/2019		Damage Report	<b>Damage reported: minor damage</b> ⓘ - Damage to front
<div data-bbox="81 1144 478 1252" data-label="Text"><p><b>CARFAX HAS THE MOST ACCIDENT &amp; DAMAGE INFORMATION</b></p></div> <div data-bbox="547 974 834 1265" data-label="Image"></div> <div data-bbox="898 902 1313 1061" data-label="Figure"><p><b>Damage Severity Scale</b></p><p>Minor      Moderate      Severe</p></div> <div data-bbox="898 1072 1313 1500" data-label="Diagram"><p><b>Damage Location</b></p><p>FRONT</p><p>LEFT      RIGHT</p><p>REAR</p></div>			
10/01/2020		Georgia Motor Vehicle Dept. Bishop, GA Title #771719182352965	<b>Registration issued or renewed</b> - Vehicle color noted as Red
10/04/2021		Georgia Motor Vehicle Dept. Bishop, GA Title #771719182352965	<b>Registration issued or renewed</b> - Vehicle color noted as Red
10/29/2021	50,420	Mazda Mall Of Georgia Buford, GA	<b>Vehicle offered for sale</b>
01/20/2022		Georgia Motor Vehicle Dept.	<b>Vehicle purchase reported</b>
02/11/2022	53,498	Georgia Inspection Station	<b>Passed emissions inspection</b>

**Owner 2**  
Purchased: 2022

Personal Vehicle









 **Owner 2**  
Purchased: 2022

Personal Vehicle

Date	Mileage	Source	Comments
02/11/2022		Georgia Motor Vehicle Dept. Lawrenceville, GA Title #770104276200965	<b>Title or registration issued</b> - New owner reported - Loan or lien reported - Vehicle color noted as Red
04/05/2022	55,421	Mazda Mall Of Georgia Buford, GA	<b>Vehicle offered for sale</b>

 **Owner 3**  
Purchased: 2022

Personal Vehicle



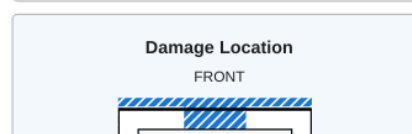
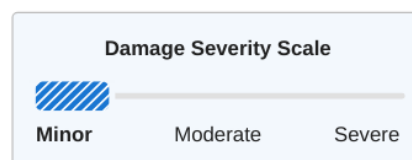





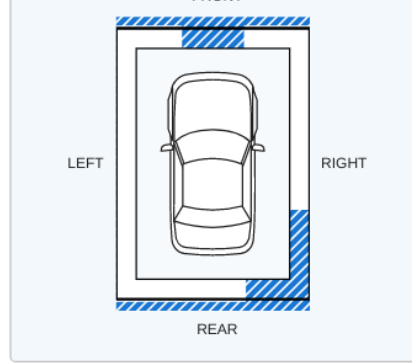





Date	Mileage	Source	Comments
05/25/2022		Georgia Motor Vehicle Dept.	<b>Vehicle purchase reported</b>
06/06/2022		Georgia Motor Vehicle Dept. Gainesville, GA Title #770119236814965	<b>Title issued or updated</b> - Title or registration issued - New owner reported - Loan or lien reported - Vehicle color noted as Red
09/02/2022 	64,515	Club Corners Car Wash - Gainesville Gainesville, GA 770-536-6464  3 Customer Favorites	<b>Vehicle serviced</b> - Oil and filter changed
11/11/2022 	68,977	Club Corners Car Wash - Gainesville Gainesville, GA 770-536-6464  3 Customer Favorites	<b>Vehicle serviced</b> - Oil and filter changed
01/20/2023 	73,410	Club Corners Car Wash - Gainesville Gainesville, GA 770-536-6464  3 Customer Favorites	<b>Vehicle serviced</b> - Oil and filter changed
04/15/2023 	78,504	Club Corners Car Wash - Gainesville Gainesville, GA 770-536-6464  3 Customer Favorites	<b>Vehicle serviced</b> - Air filter replaced - Cabin air filter replaced/cleaned - Oil and filter changed - Transmission fluid changed
06/04/2023		Georgia Motor Vehicle Dept. Gainesville, GA Title #770119236814965	<b>Registration issued or renewed</b> - Loan or lien reported - Vehicle color noted as Red
06/27/2023		Damage Report	<b>Accident reported: minor damage</b>  - Damage to right rear - Damage to front - Airbags did not deploy





**CARFAX HAS THE MOST  
ACCIDENT & DAMAGE**

**CARFAX HAS THE MOST ACCIDENT & DAMAGE INFORMATION**



09/13/2023 	83,381	Club Corners Car Wash - Gainesville Gainesville, GA 770-536-6464  3 Customer Favorites	<b>Vehicle serviced</b> -Oil and filter changed
01/08/2024 	88,671	Club Corners Car Wash - Gainesville Gainesville, GA 770-536-6464  3 Customer Favorites	<b>Vehicle serviced</b> -Oil and filter changed
06/10/2024 	93,734	Club Corners Car Wash - Gainesville Gainesville, GA 770-536-6464  3 Customer Favorites	<b>Vehicle serviced</b> -Oil and filter changed
06/16/2024		Georgia Motor Vehicle Dept. Gainesville, GA Title #770119236814965	<b>Registration issued or renewed</b> -Loan or lien reported -Vehicle color noted as Red
10/10/2024 	98,719	Club Corners Car Wash - Gainesville Gainesville, GA 770-536-6464  3 Customer Favorites	<b>Vehicle serviced</b> -Oil and filter changed
02/01/2025 	103,893	Club Corners Car Wash - Gainesville Gainesville, GA 770-536-6464  3 Customer Favorites	<b>Vehicle serviced</b> -Oil and filter changed
04/04/2025 	105,653	Jim Shorkey Mazda Gainesville, GA 470-208-1516 jimshorkeymazda.com/  600 Customer Favorites	<b>Vehicle serviced</b> -Cylinder head gasket(s) replaced -Cylinder head replaced
06/05/2025		Georgia Motor Vehicle Dept. Gainesville, GA Title #770119236814965	<b>Registration issued or renewed</b> -Loan or lien reported -Vehicle color noted as Red
07/07/2025 	109,570	Club Corners Car Wash - Gainesville Gainesville, GA 770-536-6464  3 Customer Favorites	<b>Vehicle serviced</b> -Oil and filter changed

12/31/2025 		Damage Report	<b>Accident reported: moderate damage</b>  -Damage to front -Airbag deployed <a href="#">CARFAX Airbag Tips</a>
--	--	---------------	---

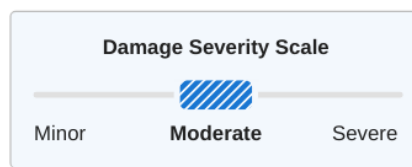

**CARFAX HAS THE MOST ACCIDENT & DAMAGE INFORMATION**

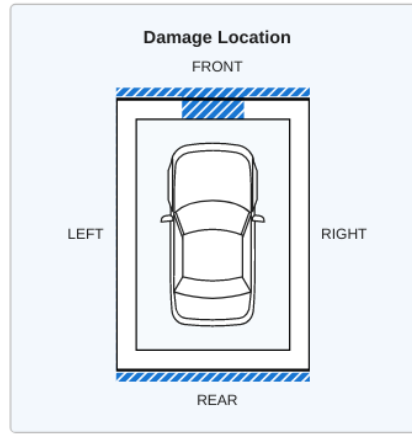

04/03/2026		Georgia Motor Vehicle Dept.	<b>Vehicle purchase reported</b>
04/07/2026		Damage Report	<b>TOTAL LOSS VEHICLE</b>
			There are many reasons an insurance company will declare a vehicle a total loss. Have this vehicle inspected by a qualified technician before you buy. <a href="#">Learn More</a>
04/07/2026		Georgia Motor Vehicle Dept.	<b>Title or registration issued to insurance company</b>
04/07/2026	114,000	Georgia Motor Vehicle Dept. Cleveland, OH Title #400270261678964	<b>SALVAGE TITLE/CERTIFICATE ISSUED</b> <b>-NOT ACTUAL MILEAGE TITLE ISSUED</b> -Vehicle color noted as Red
			A NAM title is issued when the owner discloses to a DMV mileage fraud, a broken odometer or that the actual mileage of this vehicle is unknown. Mileage reported after this reading is potentially unreliable.

Have Questions? Consumers, please visit our Help Center at [www.carfax.com](http://www.carfax.com). Dealers or Subscribers, please visit our Help Center at [www.carfaxonline.com](http://www.carfaxonline.com).

**Accident Indicator**

CARFAX receives information about accidents in all 50 states, the District of Columbia and Canada.

Not every accident is reported to CARFAX. As details about the accident become available, those additional details are added to the CARFAX Vehicle History Report. CARFAX recommends that you have this vehicle inspected by a qualified mechanic.

- According to the National Safety Council, Injury Facts, 2021 edition, 5% of the 276 million registered vehicles in the U.S. were involved in an accident in 2019. Over 77% of these were considered minor or moderate.
- This CARFAX Vehicle History Report is based only on information supplied to CARFAX and available as of 4/23/26 at 8:46:01 AM (CDT). Other information about this vehicle, including problems, may not have been reported to CARFAX. Use this report as one important tool, along with a vehicle inspection and test drive, to make a better decision about your next used car.

**Airbag Deployment**

Occurs when the driver, passenger or side airbag has been used or deployed during a crash or other incident. If an airbag has been deployed, it must be replaced by a qualified technician. Have this car inspected by a mechanic prior to purchase.

**Damage Indicator**

Damage can be a result of many different types of events. Examples include contact with objects (other cars, trees, traffic signs, road debris, etc), vandalism, or weather-related events. Not every damage event is reported to CARFAX. As details about the damage event become available, those additional details are added to the CARFAX Vehicle History Report. CARFAX recommends that you have this vehicle inspected by a qualified mechanic.

- This CARFAX Vehicle History Report is based only on information supplied to CARFAX and available as of 4/23/26 at 8:46:01 AM (CDT). Other information about this vehicle, including problems, may not have been reported to CARFAX. Use this report as one important tool, along with a

- This CARFAX Vehicle History Report is based only on information supplied to CARFAX and available as of 4/23/26 at 8:46:01 AM (CDT). Other information about this vehicle, including problems, may not have been reported to CARFAX. Use this report as one important tool, along with a vehicle inspection and test drive, to make a better decision about your next used car.

### Damage Severity

Damage events result in one of the following severity levels:

- Minor: Generally, minor damage is cosmetic (including dents or scratches), may only require reconditioning, and typically does not compromise a vehicle's operation and/or safety.
- Moderate: Moderate damage may affect multiple components of the vehicle and may impair the vehicle's operation and/or safety.
- Severe: Severe damage usually affects multiple components of the vehicle and is likely to compromise the vehicle's operation and/or safety.

CARFAX recommends getting a pre-purchase inspection at a certified collision repair facility.

### Federal Odometer Act

The Federal Odometer Act requires a seller to disclose the vehicle's mileage on the title when ownership is transferred. Congress enacted this Act to prohibit odometer tampering and to protect consumers from mileage fraud. Under this act, sellers must disclose any issues with the vehicle's odometer. These disclosures translate into the Exceed Mechanical Limits and Not Actual Mileage titles.

### First Owner

When the first owner(s) obtains a title from a Department of Motor Vehicles as proof of ownership.

### New Owner Reported

When a vehicle is sold to a new owner, the Title must be transferred to the new owner(s) at a Department of Motor Vehicles.

### Not Actual Mileage Title

When the seller certifies, under the Federal Odometer Act, that the odometer reading does not reflect the vehicle's actual mileage. This may occur because the odometer was tampered with, broken, or replaced.

### Ownership History

CARFAX defines an owner as an individual or business that possesses and uses a vehicle. Not all title transactions represent changes in ownership. To provide estimated number of owners, CARFAX proprietary technology analyzes all the events in a vehicle history. Estimated ownership is available for vehicles manufactured after 1991 and titled solely in the US including Puerto Rico. Dealers sometimes opt to take ownership of a vehicle and are required to in the following states: Maine, Massachusetts, New Jersey, Ohio, Oklahoma, Pennsylvania and South Dakota. Please consider this as you review a vehicle's estimated ownership history.

### Salvage Title

A Salvage Title is issued on a vehicle damaged to the extent that the cost of repairing the vehicle exceeds approximately 75% of its pre-damage value. This damage threshold may vary by state. Some states treat Junk titles the same as Salvage but the majority use this title to indicate that a vehicle is not road worthy and cannot be titled again in that state. The following eleven states also use Salvage titles to identify stolen vehicles - AZ, FL, GA, IL, MD, MN, NJ, NM, NY, OK and OR.

### Title Issued

A state issues a title to provide a vehicle owner with proof of ownership. Each title has a unique number. Each title or registration record on a CARFAX report does not necessarily indicate a change in ownership. In Canada, a registration and bill of sale are used as proof of ownership.

### Total Loss Vehicle

An insurance or fleet company declares a vehicle a total loss when a claim exceeds approximately 75% of its pre-damage value or if the vehicle is stolen and not recovered. This damage threshold varies by company. These companies typically take possession and obtain the title. Not all total loss vehicles result in a DMV-reported branded title. This may occur when an insurance company's definition of a total loss is different than the state DMV's definition for a branded title or when the owner of the vehicle is a self-insured company, like a fleet or rental company.

[Full Glossary](#)

Follow Us:



[facebook.com/CARFAX](https://facebook.com/CARFAX)



[@CARFAXinc](https://twitter.com/CARFAXinc)



[About CARFAX](#)

CARFAX DEPENDS ON ITS SOURCES FOR THE ACCURACY AND RELIABILITY OF ITS INFORMATION. THEREFORE, NO RESPONSIBILITY IS ASSUMED BY CARFAX OR ITS AGENTS FOR ERRORS OR OMISSIONS IN THIS REPORT. CARFAX FURTHER EXPRESSLY DISCLAIMS ALL WARRANTIES, EXPRESS OR IMPLIED, INCLUDING ANY IMPLIED WARRANTIES OF MERCHANTABILITY OR FITNESS FOR A PARTICULAR PURPOSE.

© 2026 CARFAX, Inc., part of S&P Global. All rights reserved.  
4/23/26 8:46:01 AM (CDT)

I have reviewed and received a copy of the CARFAX Vehicle History Report for this 2018 MAZDA MAZDA6 vehicle (VIN: JM1GL1XY2J1320052), which is based on information supplied to CARFAX and available as of 4/23/26 at 9:46 AM (EDT).

Customer Signature

Date

Dealer Signature

Date

