

History-Based Value Report

\$18,950

CARFAX Retail Value

History events affecting this vehicle's value

- 1-Owner Vehicle
- Service History
- Personal Vehicle
- Salvage Brand

Vehicle History Report™

US \$44.99

2020 TOYOTA PRIUS PRIME XLE

VIN: JTDKARFP6L3146081
 HATCHBACK 4 DR
 1.8L I4 F DOHC 16V
 HYBRID
 FRONT WHEEL DRIVE

Branded Title: Salvage >

14 Service history records >

CARFAX 1-Owner vehicle >

Personal vehicle >

Last owned in California >

42,644 Last reported odometer reading >

This CARFAX Vehicle History Report is based only on [information](#) supplied to CARFAX and available as of 2/26/26 at 1:28:36 AM (CST). Other information about this vehicle, including problems, may not have been reported to CARFAX. Use this report as one important tool, along with a vehicle inspection and test drive, to make a better decision about your next used car.

Accident / Damage History

Not all accidents / issues are reported to CARFAX

Event 1

06/27/2023

Damage reported: very minor damage

[View More Details >](#)

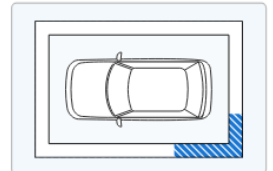
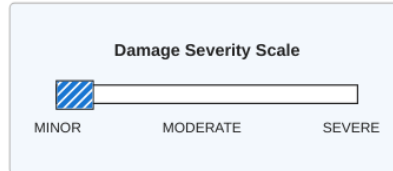

Event 2

11/06/2025

Accident reported: minor to moderate damage

[View More Details >](#)

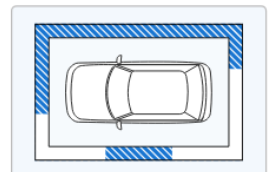
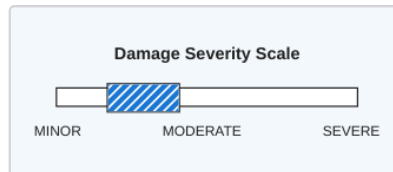

CARFAX Additional History
Not all accidents / issues are reported to CARFAX

Owner 1

<p>Total Loss ⓘ No total loss reported to CARFAX.</p>	<p>✔ No Issues Reported</p>
<p>Structural Damage ⓘ CARFAX recommends that you have this vehicle inspected by a collision repair specialist.</p>	<p>✔ No Issues Reported</p>
<p>Airbag Deployment ⓘ No airbag deployment reported to CARFAX.</p>	<p>✔ No Issues Reported</p>
<p>Odometer Check ⓘ No indication of an odometer rollback.</p>	<p>✔ No Issues Indicated</p>
<p>Accident / Damage ⓘ DMV title problems reported. Damage reported: 06/27/2023. Accident reported: 11/06/2025.</p>	<p>Severe Damage</p>
<p>Manufacturer Recall ⓘ No open recalls reported to CARFAX. View Toyota disclosure</p>	<p>✔ No Recalls Reported</p>
<p>Basic Warranty ⓘ Original manufacturer warranty likely voided by manufacturer.</p>	<p>Warranty Voided</p>

CARFAX Title History

Owner 1

<p>Damage Brands ⓘ Salvage Junk Rebuilt Fire Flood Hail Lemon</p>	<p>Alert! Problem Found</p>
<p>Odometer Brands ⓘ Not Actual Mileage Exceeds Mechanical Limits</p>	<p>No Problem</p>
<p>ALERT! - Severe problems were reported by a state Department of Motor Vehicles (DMV). This vehicle does not qualify for the CARFAX Buyback Guarantee.</p>	

CARFAX Ownership History
The number of owners is estimated

Owner 1











Year purchased	2020
Type of owner	Personal
Estimated length of ownership	6 yrs. 1 mo.
Owned in the following states/provinces	California
Estimated miles driven per year	9,578/yr
Last reported odometer reading	42,644

CARFAX Detailed History

[Glossary](#)

Owner 1 Personal Vehicle
Purchased: 2020 9,578 mi/yr

Date	Mileage	Source	Comments
------	---------	--------	----------

12/28/2019		Toyota Motor Sales, USA, Inc.		
01/06/2020	7	City Toyota Daly City, CA 650-755-5500 citytoyota.com  14,447 Customer Favorites		Vehicle serviced -Pre-delivery inspection completed
01/21/2020	14	California Motor Vehicle Dept. Burlingame, CA		Odometer reading reported
01/29/2020		California Motor Vehicle Dept. Burlingame, CA		Title issued or updated -First owner reported -Titled or registered as personal vehicle
10/06/2020	5,086	Toyota 101 Redwood City, CA 650-365-5000 toyota101.com		Vehicle serviced -Maintenance inspection completed -5,000 mile service performed -Carpet/floor mats secured -Fluids checked -Oil and filter changed -Tire condition and pressure checked -Tires rotated
01/13/2021	7,219	Toyota 101 Redwood City, CA 650-365-5000 toyota101.com		Vehicle serviced -10,000 mile service performed -Carpet/floor mats secured -Maintenance reminder reset -Oil and filter changed -Tire condition and pressure checked -Tires rotated
07/08/2021	12,496	Toyota 101 Redwood City, CA 650-365-5000 toyota101.com		Vehicle serviced -15,000 mile service performed -Brakes checked -Oil and filter changed -Tire condition and pressure checked -Tires rotated
12/10/2021	17,632	Toyota 101 Redwood City, CA 650-365-5000 toyota101.com		Vehicle serviced -20,000 mile service performed -Oil and filter changed -Tire condition and pressure checked
06/03/2022	25,566	Toyota 101 Redwood City, CA 650-365-5000 toyota101.com		Vehicle serviced -25,000 mile service performed -Oil and filter changed -Tire condition and pressure checked -Tires rotated
10/18/2022	26,376	Toyota 101 Redwood City, CA 650-365-5000 toyota101.com		Vehicle serviced -Maintenance inspection completed -Radio/sound system checked -Tire condition and pressure checked
12/09/2022	27,934	Toyota 101 Redwood City, CA 650-365-5000 toyota101.com		Vehicle serviced -Maintenance inspection completed -30,000 mile service performed -Carpet/floor mats secured -Fluids checked -Oil and filter changed -Tire condition and pressure checked -Tires rotated
05/17/2023	32,862	Toyota 101 Redwood City, CA 650-365-5000 toyota101.com		Vehicle serviced -Maintenance inspection completed -Recommended maintenance performed -35,000 mile service performed -Brakes checked -Brake fluid flushed/changed -Carpet/floor mats secured -Fluids checked -Tire condition and pressure checked -Tires rotated

06/27/2023

Damage Report



Damage reported: very minor damage

- Damage to left rear

CARFAX HAS THE MOST ACCIDENT & DAMAGE INFORMATION

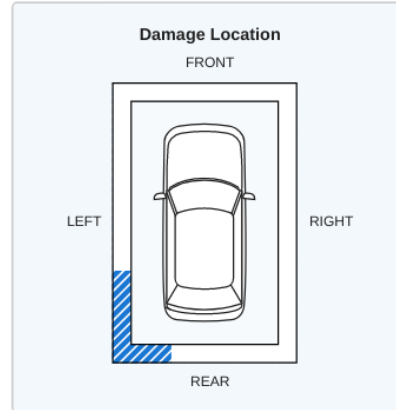
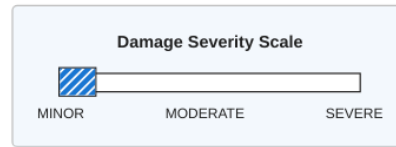

09/28/2023

37,279

Toyota 101
Redwood City, CA
650-365-5000
toyota101.com



Vehicle serviced

- Maintenance inspection completed
- Recommended maintenance performed
- Fluids checked
- Oil and filter changed
- Tire condition and pressure checked
- Trim checked

03/28/2024

40,815

Toyota 101
Redwood City, CA
650-365-5000
toyota101.com



Vehicle serviced

- Maintenance inspection completed
- Recommended maintenance performed
- Battery replaced
- Tire condition and pressure checked

05/09/2024

41,489

Toyota 101
Redwood City, CA
650-365-5000
toyota101.com



Vehicle serviced

- Maintenance inspection completed
- Tire condition and pressure checked

06/24/2024

42,244

Toyota 101
Redwood City, CA
650-365-5000
toyota101.com



Vehicle serviced

- Maintenance inspection completed
- Carpet/floor mats secured
- Interior cleaned
- Oil and filter changed
- Tire condition and pressure checked
- Tires rotated
- Trim checked

07/11/2024

42,644

Toyota 101
Redwood City, CA
650-365-5000
toyota101.com



Vehicle serviced

- Maintenance inspection completed
- Fender liner replaced/repared
- Tire condition and pressure checked
- Trim checked

11/06/2025

Damage Report



Accident reported: minor to moderate damage

- Damage to front
- Damage to right front
- Damage to right rear
- Damage to right side
- Damage to left side

CARFAX HAS THE MOST ACCIDENT & DAMAGE INFORMATION

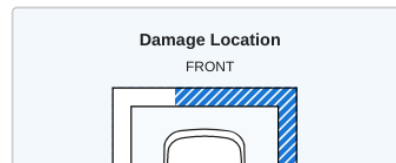
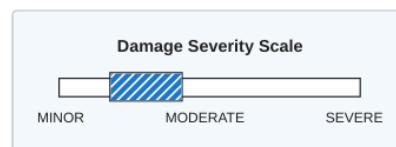

ACCIDENT & DAMAGE INFORMATION

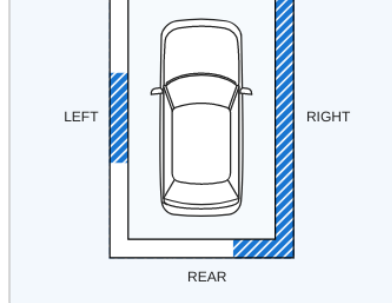

02/21/2026

Damage Report



SALVAGE TITLE/CERTIFICATE ISSUED

Have Questions? Consumers, please visit our Help Center at www.carfax.com. Dealers or Subscribers, please visit our Help Center at www.carfaxonline.com.

CARFAX Glossary

[Full Glossary](#)

Accident Indicator

CARFAX receives information about accidents in all 50 states, the District of Columbia and Canada.

Not every accident is reported to CARFAX. As details about the accident become available, those additional details are added to the CARFAX Vehicle History Report. CARFAX recommends that you have this vehicle inspected by a qualified mechanic.

- According to the National Safety Council, Injury Facts, 2021 edition, 5% of the 276 million registered vehicles in the U.S. were involved in an accident in 2019. Over 77% of these were considered minor or moderate.
- This CARFAX Vehicle History Report is based only on information supplied to CARFAX and available as of 2/26/26 at 1:28:36 AM (CST). Other information about this vehicle, including problems, may not have been reported to CARFAX. Use this report as one important tool, along with a vehicle inspection and test drive, to make a better decision about your next used car.

Damage Indicator

Damage can be a result of many different types of events. Examples include contact with objects (other cars, trees, traffic signs, road debris, etc), vandalism, or weather-related events. Not every damage event is reported to CARFAX. As details about the damage event become available, those additional details are added to the CARFAX Vehicle History Report. CARFAX recommends that you have this vehicle inspected by a qualified mechanic.

- This CARFAX Vehicle History Report is based only on information supplied to CARFAX and available as of 2/26/26 at 1:28:36 AM (CST). Other information about this vehicle, including problems, may not have been reported to CARFAX. Use this report as one important tool, along with a vehicle inspection and test drive, to make a better decision about your next used car.

Damage Severity

Damage events result in one of the following severity levels:

- Minor: Generally, minor damage is cosmetic (including dents or scratches), may only require reconditioning, and typically does not compromise a vehicle's operation and/or safety.
- Moderate: Moderate damage may affect multiple components of the vehicle and may impair the vehicle's operation and/or safety.
- Severe: Severe damage usually affects multiple components of the vehicle and is likely to compromise the vehicle's operation and/or safety.

CARFAX recommends getting a pre-purchase inspection at a certified collision repair facility.

First Owner

When the first owner(s) obtains a title from a Department of Motor Vehicles as proof of ownership.

Ownership History

CARFAX defines an owner as an individual or business that possesses and uses a vehicle. Not all title transactions represent changes in ownership. To provide estimated number of owners, CARFAX proprietary technology analyzes all the events in a vehicle history. Estimated ownership is available for vehicles manufactured after 1991 and titled solely in the US including Puerto Rico. Dealers sometimes opt to take ownership of a vehicle and are required to in the following states: Maine, Massachusetts, New Jersey, Ohio, Oklahoma, Pennsylvania and South Dakota. Please consider this as you review a vehicle's estimated ownership history.

Salvage Title

A Salvage Title is issued on a vehicle damaged to the extent that the cost of repairing the vehicle exceeds approximately 75% of its pre-damage value. This damage threshold may vary by state. Some states treat Junk titles the same as Salvage but the majority use this title to indicate that a vehicle is not road worthy and cannot be titled again in that state. The following eleven states also use Salvage titles to identify stolen vehicles - AZ, FL, GA, IL, MD, MN, NJ, NM, NY, OK and OR.

Title Issued

A state issues a title to provide a vehicle owner with proof of ownership. Each title has a unique number. Each title or registration record on a CARFAX report does not necessarily indicate a change in ownership. In Canada, a registration and bill of sale are used as proof of ownership.

Toyota Recall / Service Campaign

Portions of this report have been included under license from Toyota Motor North America, Inc. ("TOYOTA"), License Agreement TMS1013. This data applies only to vehicle marketed or originally sold in Mexico and the United States of America, including Guam, Saipan, American Samoa, Puerto Rico, the U.S. Virgin Islands and the other United States territories and protectorates with currently open safety or emissions recalls, or service campaigns. While TOYOTA provides data to Carfax Inc. on a regular basis, this report may not include very recent activity. For the manufacturer's most current information on recall/campaign activity for any Toyota, Lexus or Scion brand vehicle, you must go to <http://toyota.com/recall> or <http://lexus.com/recall>.

regular basis, this report may not include very recent activity. For the manufacturer's most current information on recall/campaign activity for any Toyota, Lexus or Scion brand vehicle, you must go to <http://toyota.com/recall> or <http://lexus.com/recall>.

Follow

Us:



facebook.com/CARFAX



[@CARFAXinc](https://twitter.com/CARFAXinc)



[About CARFAX](#)

CARFAX DEPENDS ON ITS SOURCES FOR THE ACCURACY AND RELIABILITY OF ITS INFORMATION. THEREFORE, NO RESPONSIBILITY IS ASSUMED BY CARFAX OR ITS AGENTS FOR ERRORS OR OMISSIONS IN THIS REPORT. CARFAX FURTHER EXPRESSLY DISCLAIMS ALL WARRANTIES, EXPRESS OR IMPLIED, INCLUDING ANY IMPLIED WARRANTIES OF MERCHANTABILITY OR FITNESS FOR A PARTICULAR PURPOSE.

© 2026 CARFAX, Inc., part of S&P Global. All rights reserved.

2/26/26 1:28:36 AM (CST)

I have reviewed and received a copy of the CARFAX Vehicle History Report for this 2020 TOYOTA PRIUS PRIME vehicle (VIN: JTDKARFP6L3146081), which is based on information supplied to CARFAX and available as of 2/26/26 at 2:28 AM (EST).

Customer Signature

Date

Dealer Signature

Date