

2023 Toyota Rav4 Prime SE

32,722 mi | VIN: JTMAB3FV4PD146813

[Vehicle Details](#) ▾

CARFAX HAS THE MOST ACCIDENT & DAMAGE INFORMATION



BRANDED TITLE >

Salvage

CARFAX VALUE \$25,220 >

[Update Trim & Options](#)

Regular oil changes >

CARFAX 1-Owner vehicle >

Personal vehicle >

Last owned in New York >

20 Detailed records available >

This CARFAX Vehicle History Report is based only on [information](#) supplied to CARFAX and available as of 4/14/26 at 7:17:48 AM (CDT). Other information about this vehicle, including problems, may not have been reported to CARFAX. Use this report as one important tool, along with a vehicle inspection and test drive, to make a better decision about your next used car.

Accident / Damage History

Not all accidents / issues are reported to CARFAX

Event 1

01/26/2026

TOTAL LOSS VEHICLE

- Accident reported
- Vehicle declared a total loss by an insurance company

[View More Details](#) >

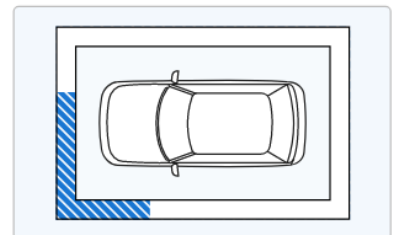

Event 2

02/02/2026

Damage reported: moderate damage ⓘ

Damage Severity Scale

02/02/2026

Damage reported: moderate damage ⓘ

- Airbag deployed

[View More Details >](#)

Damage Severity Scale

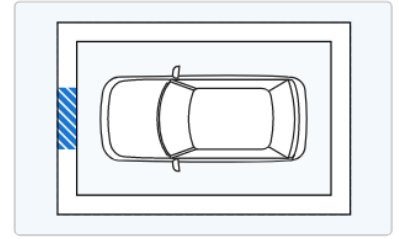
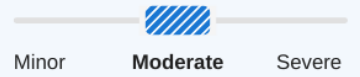

CARFAX Recent Service Highlights

Key services performed in the last 12 months

Service	Comments	Date	
Oil	✓ Oil and filter changed	11/08/2025	View Details >
Tires	✓ Tire(s) replaced ✓ Tires rotated ✓ Two tires replaced	11/08/2025	View Details >

This car has been recently serviced. That's a good thing!

CARFAX History-Based Value Report

\$25,220

CARFAX Retail Value

History events affecting this vehicle's value

- ↑ 1 1-Owner Vehicle
- ↑ Regular Oil Changes
- ↓ Salvage Brand
- ↓ Airbag Deployed

CARFAX Additional History

Not all accidents / issues are reported to CARFAX

Owner 1

Total Loss ⓘ

Total Loss Reported: 01/26/2026.

[Total Loss Reported](#)

Structural Damage ⓘ

CARFAX recommends that you have this vehicle inspected by a collision repair specialist.



Airbag Deployment ⓘ

Airbag deployment reported: 02/02/2026.

[Airbag Deployment](#)

Odometer Check ⓘ

No indication of an odometer rollback.



Accident / Damage ⓘ



Severe Damage

















Accident / Damage ⓘ DMV title problems reported. Accident reported: 01/26/2026. Damage reported: 02/02/2026.	Severe Damage
Manufacturer Recall ⓘ No open recalls reported to CARFAX. View Toyota disclosure	No Recalls Reported
Basic Warranty ⓘ Original manufacturer warranty likely voided by manufacturer.	Warranty Voided

CARFAX Title History	Owner 1
Damage Brands ⓘ Salvage Junk Rebuilt Fire Flood Hail Lemon	Alert! Problem Found
Odometer Brands ⓘ Not Actual Mileage Exceeds Mechanical Limits	No Problem
 ALERT! - Severe problems were reported by a state Department of Motor Vehicles (DMV). This vehicle does not qualify for the CARFAX Buyback Guarantee.	

CARFAX Ownership History <small>The number of owners is estimated</small>	Owner 1
Year purchased	2023
Type of owner	Personal
Estimated length of ownership	2 yrs. 6 mo.
Owned in the following states/provinces	New York
Estimated miles driven per year	14,618/yr
Last reported odometer reading	32,722

CARFAX Detailed History [Glossary](#)

 Owner 1 Purchased: 2023			Personal Vehicle 14,618 mi/yr
Date	Mileage	Source	Comments
07/28/2023		Toyota Motor Sales, USA, Inc.	Vehicle manufactured and shipped to original dealer
08/05/2023		Millennium Toyota Hempstead, NY 516-485-1400 millenniumtoyota.com  12,585 Customer Favorites	Vehicle offered for sale
08/05/2023	6	New York Inspection Station	Passed safety inspection -Emissions inspection performed
08/07/2023		 Millennium Toyota Hempstead, NY 516-485-1400	Vehicle serviced -Safety inspection performed

		 Hempstead, NY 516-485-1400 millenniumtoyota.com  12,585 Customer Favorites	- Safety inspection performed
08/13/2023		Millennium Toyota Hempstead, NY 516-485-1400 millenniumtoyota.com  12,585 Customer Favorites	Vehicle sold
09/11/2023		New York Motor Vehicle Dept. Glen Cove, NY	Title issued or updated -Registration issued or renewed -First owner reported -Titled or registered as personal vehicle -Loan or lien reported -Passed safety inspection
12/09/2023	5,424	 Millennium Toyota Hempstead, NY 516-485-1400 millenniumtoyota.com  12,585 Customer Favorites	Vehicle serviced -Recommended maintenance performed -Anti-theft/keyless device/alarm repaired -Tires rotated
04/30/2024	11,296	 Millennium Toyota Hempstead, NY 516-485-1400 millenniumtoyota.com  12,585 Customer Favorites	Vehicle serviced -10,000 mile service performed -Emissions or safety inspection performed -Oil and filter changed -Tire condition and pressure checked -Tires rotated
08/10/2024	15,334	 Millennium Toyota Hempstead, NY 516-485-1400 millenniumtoyota.com  12,585 Customer Favorites	Vehicle serviced -Drive belts checked -Safety inspection performed -Tires rotated
08/10/2024	15,344	New York Inspection Station	Passed safety inspection -Emissions inspection performed
11/23/2024	19,381	 Millennium Toyota Hempstead, NY 516-485-1400 millenniumtoyota.com  12,585 Customer Favorites	Vehicle serviced -Emissions or safety inspection performed -Oil and filter changed -Tires rotated
05/07/2025	26,127	 Millennium Toyota Hempstead, NY 516-485-1400 millenniumtoyota.com  12,585 Customer Favorites	Vehicle serviced -Maintenance inspection completed -Emissions or safety inspection performed -Oil and filter changed -Tires rotated
05/20/2025		New York Motor Vehicle Dept. Glen Cove, NY	Registration issued or renewed -Titled or registered as personal vehicle -Passed safety inspection
07/12/2025	28,573	New York Inspection Station	Passed safety inspection -Passed emissions inspection
11/08/2025	32,722	 Millennium Toyota Hempstead, NY 516-485-1400 millenniumtoyota.com  12,585 Customer Favorites	Vehicle serviced -Oil and filter changed -Tire(s) replaced -Tires rotated -Two tires replaced
01/26/2026		 Damage Report	TOTAL LOSS VEHICLE -Accident reported -Vehicle declared a total loss by an insurance company -Damage to front -Damage to left front

-Damage to left front

CARFAX HAS THE MOST ACCIDENT & DAMAGE INFORMATION

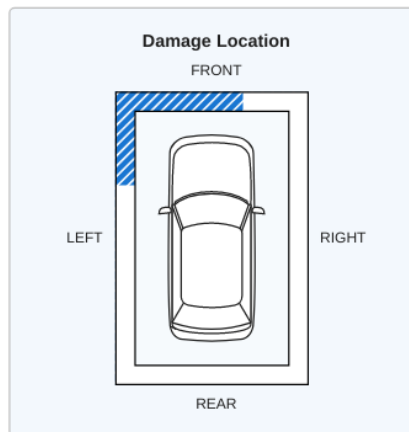

There are many reasons an insurance company will declare a vehicle a total loss. Have this vehicle inspected by a qualified technician before you buy. [Learn More](#)

02/02/2026



Damage Report

Damage reported: moderate damage ⓘ

- Damage to front
 - Airbag deployed
- [CARFAX Airbag Tips](#)

CARFAX HAS THE MOST ACCIDENT & DAMAGE INFORMATION

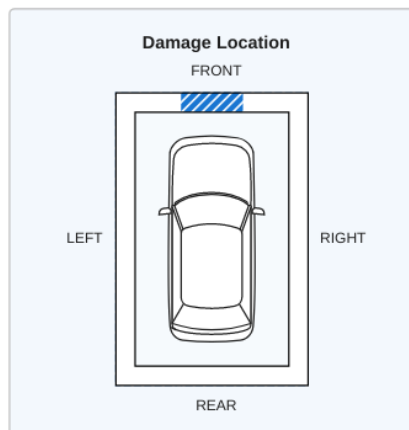
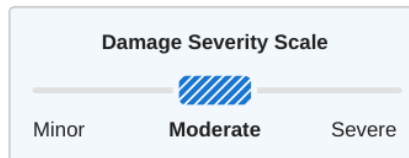

04/09/2026

New York
Motor Vehicle Dept.

Title or registration issued to insurance company

04/09/2026



New York
Motor Vehicle Dept.
Albany, NY

SALVAGE TITLE/CERTIFICATE ISSUED

04/10/2026



Damage Report

SALVAGE TITLE/CERTIFICATE ISSUED



This vehicle's oil change history, as reported to CARFAX, follows the manufacturer's recommendation. Track your service history for free at carfax.com/service.

Have Questions? Consumers, please visit our Help Center at www.carfax.com. Dealers or Subscribers, please visit our Help Center at www.carfaxonline.com.

Accident Indicator

CARFAX receives information about accidents in all 50 states, the District of Columbia and Canada.

Not every accident is reported to CARFAX. As details about the accident become available, those additional details are added to the CARFAX Vehicle History Report. CARFAX recommends that you have this vehicle inspected by a qualified mechanic.

- According to the National Safety Council, Injury Facts, 2021 edition, 5% of the 276 million registered vehicles in the U.S. were involved in an accident in 2019. Over 77% of these were considered minor or moderate.
- This CARFAX Vehicle History Report is based only on information supplied to CARFAX and available as of 4/14/26 at 7:17:48 AM (CDT). Other information about this vehicle, including problems, may not have been reported to CARFAX. Use this report as one important tool, along with a vehicle inspection and test drive, to make a better decision about your next used car.

Airbag Deployment

Occurs when the driver, passenger or side airbag has been used or deployed during a crash or other incident. If an airbag has been deployed, it must be replaced by a qualified technician. Have this car inspected by a mechanic prior to purchase.

CARFAX Well Maintained - Regular Oil Changes

CARFAX identifies a "Well Maintained - Regular Oil Change" vehicle as having a regular oil change history when all its recommended oil changes, based on the vehicle's maintenance schedule, have been reported to CARFAX. CARFAX uses the manufacturer's schedule and assumes normal driving conditions. When an oil change schedule is not available, CARFAX may analyze reported service events to determine what is typical for the same make and model vehicle. Dealers and service shops may publish different recommended service schedules.

Damage Indicator

Damage can be a result of many different types of events. Examples include contact with objects (other cars, trees, traffic signs, road debris, etc), vandalism, or weather-related events. Not every damage event is reported to CARFAX. As details about the damage event become available, those additional details are added to the CARFAX Vehicle History Report. CARFAX recommends that you have this vehicle inspected by a qualified mechanic.

- This CARFAX Vehicle History Report is based only on information supplied to CARFAX and available as of 4/14/26 at 7:17:48 AM (CDT). Other information about this vehicle, including problems, may not have been reported to CARFAX. Use this report as one important tool, along with a vehicle inspection and test drive, to make a better decision about your next used car.

Damage Severity

Damage events result in one of the following severity levels:

- Minor: Generally, minor damage is cosmetic (including dents or scratches), may only require reconditioning, and typically does not compromise a vehicle's operation and/or safety.
- Moderate: Moderate damage may affect multiple components of the vehicle and may impair the vehicle's operation and/or safety.
- Severe: Severe damage usually affects multiple components of the vehicle and is likely to compromise the vehicle's operation and/or safety.

CARFAX recommends getting a pre-purchase inspection at a certified collision repair facility.

First Owner

When the first owner(s) obtains a title from a Department of Motor Vehicles as proof of ownership.

Ownership History

CARFAX defines an owner as an individual or business that possesses and uses a vehicle. Not all title transactions represent changes in ownership. To provide estimated number of owners, CARFAX proprietary technology analyzes all the events in a vehicle history. Estimated ownership is available for vehicles manufactured after 1991 and titled solely in the US including Puerto Rico. Dealers sometimes opt to take ownership of a vehicle and are required to in the following states: Maine, Massachusetts, New Jersey, Ohio, Oklahoma, Pennsylvania and South Dakota. Please consider this as you review a vehicle's estimated ownership history.

Salvage Title

A Salvage Title is issued on a vehicle damaged to the extent that the cost of repairing the vehicle exceeds approximately 75% of its pre-damage value. This damage threshold may vary by state. Some states treat Junk titles the same as Salvage but the majority use this title to indicate that a vehicle is not road worthy and cannot be titled again in that state. The following eleven states also use Salvage titles to identify stolen vehicles - AZ, FL, GA, IL, MD, MN, NJ, NM, NY, OK and OR.

Title Issued

A state issues a title to provide a vehicle owner with proof of ownership. Each title has a unique number. Each title or registration record on a CARFAX report does not necessarily indicate a change in ownership. In Canada, a registration and bill of sale are used as proof of ownership.

Total Loss Vehicle

An insurance or fleet company declares a vehicle a total loss when a claim exceeds approximately 75% of its pre-damage value or if the vehicle is stolen and not recovered. This damage threshold varies by company. These companies typically take possession and obtain the title. Not all total loss vehicles result in a DMV-reported branded title. This may occur when an insurance company's definition of a total loss is different than the state DMV's definition for a branded title or when the owner of the vehicle is a self-insured company, like a fleet or rental company.

Toyota Recall / Service Campaign

Portions of this report have been included under license from Toyota Motor North America, Inc. ("TOYOTA"), License Agreement TMS1013 . This data applies only to vehicle marketed or originally sold in Mexico and the United States of America, including Guam, Saipan, American Samoa, Puerto Rico, the U.S. Virgin Islands and the other United States territories and protectorates with currently open safety or emissions recalls, or service campaigns. While TOYOTA provides data to Carfax Inc. on a regular basis, this report may not include very recent activity. For the manufacturer's most current information on recall/campaign

Islands and the other United States territories and protectorates with currently open safety or emissions recalls, or service campaigns. While TOYOTA provides data to Carfax Inc. on a regular basis, this report may not include very recent activity. For the manufacturer's most current information on recall/campaign activity for any Toyota, Lexus or Scion brand vehicle, you must go to <http://toyota.com/recall> or <http://lexus.com/recall>.

[Full Glossary](#)

Follow
Us:



facebook.com/CARFAX



[@CARFAXinc](https://twitter.com/CARFAXinc)



About CARFAX

CARFAX DEPENDS ON ITS SOURCES FOR THE ACCURACY AND RELIABILITY OF ITS INFORMATION. THEREFORE, NO RESPONSIBILITY IS ASSUMED BY CARFAX OR ITS AGENTS FOR ERRORS OR OMISSIONS IN THIS REPORT. CARFAX FURTHER EXPRESSLY DISCLAIMS ALL WARRANTIES, EXPRESS OR IMPLIED, INCLUDING ANY IMPLIED WARRANTIES OF MERCHANTABILITY OR FITNESS FOR A PARTICULAR PURPOSE.

© 2026 CARFAX, Inc., part of S&P Global. All rights reserved.
4/14/26 7:17:48 AM (CDT)

I have reviewed and received a copy of the CARFAX Vehicle History Report for this 2023 TOYOTA RAV4 PRIME vehicle (VIN: JTMAB3FV4PD146813), which is based on information supplied to CARFAX and available as of 4/14/26 at 8:17 AM (EDT).

Customer Signature

Date

Dealer Signature

Date