

2022 Mercedes-Benz Sprinter 2500

85,857 mi | VIN: W1W40CHY7NT103486

[Vehicle Details](#) ▾

CARFAX HAS THE MOST ACCIDENT & DAMAGE INFORMATION



BRANDED TITLE



Salvage



13 Service history records



4 Previous owners



Types of owners: Commercial, Personal



Last owned in South Carolina



37 Detailed records available

This CARFAX Vehicle History Report is based only on [information](#) supplied to CARFAX and available as of 4/6/26 at 9:13:13 PM (CDT). Other information about this vehicle, including problems, may not have been reported to CARFAX. Use this report as one important tool, along with a vehicle inspection and test drive, to make a better decision about your next used car.

CARFAX Accident / Damage History

Not all accidents / issues are reported to CARFAX

Event 1

12/12/2022

Accident reported: minor damage ⓘ

-Airbags did not deploy

[View More Details](#) >

Damage Severity Scale



Minor

Moderate

Severe

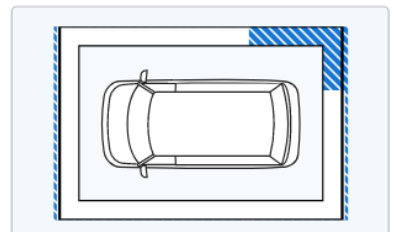

Event 2

11/11/2025

TOTAL LOSS VEHICLE

- Vehicle declared a total loss by an insurance company

[View More Details >](#)

Event 3

01/27/2026

Damage reported: minor damage ⓘ

Damage Severity Scale

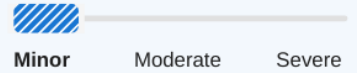

CARFAX Recent Service Highlights

Key services performed in the last 12 months

Service	Comments	Date	
Oil	✓ Oil and filter changed	10/31/2025	View Details >
Tires	✓ Tire(s) replaced	06/21/2025	View Details >

This car has been recently serviced. That's a good thing!

CARFAX Additional History

Not all accidents / issues are reported to CARFAX

	Owners 1-2	Owner 3	Owner 4
Total Loss ⓘ Total Loss Reported: 11/11/2025.	✓	✓	Total Loss Reported
Structural Damage ⓘ CARFAX recommends that you have this vehicle inspected by a collision repair specialist.	✓	✓	✓
Airbag Deployment ⓘ No airbag deployment reported to CARFAX.	✓	✓	✓
Odometer Check ⓘ No indication of an odometer rollback.	✓	✓	✓
Accident / Damage ⓘ DMV title problems reported. Accident reported: 12/12/2022. Damage reported: 01/27/2026.	Accident Reported	No New Issues Reported	Severe Damage
Manufacturer Recall ⓘ No open recalls reported to CARFAX.	No Recalls Reported	No Recalls Reported	No Recalls Reported
Basic Warranty ⓘ Original manufacturer warranty likely voided by manufacturer.	✓	✓	Warranty Voided

Title History	Owners 1-2	Owner 3	Owner 4
Damage Brands Salvage Junk Rebuilt Fire Flood Hail Lemon	No Problem	No Problem	Alert! Problem Found
Odometer Brands Not Actual Mileage Exceeds Mechanical Limits	No Problem	No Problem	No Problem
ALERT! - Severe problems were reported by a state Department of Motor Vehicles (DMV). This vehicle does not qualify for the CARFAX Buyback Guarantee.			

Ownership History	Owners 1-2	Owner 3	Owner 4
The number of owners is estimated			
Year purchased	2022	2024	2025
Type of owner	See Details	Personal	Personal
Estimated length of ownership	2 years	1 month	11 months
Owned in the following states/provinces	See Details	See Details	South Carolina
Estimated miles driven per year	---	---	---
Last reported odometer reading	16,612	23,599	85,857

Detailed History [Glossary](#)

Owner 1 Purchased: 2022		Commercial Vehicle	
Date	Mileage	Source	Comments
06/30/2022	3	Mercedes-Benz Vans Center - Baker Summerville, SC 843-377-1120 mbvanssummerville.com 1 Customer Favorite	Vehicle serviced -Pre-delivery inspection completed
07/12/2022		Mercedes-Benz of Gilbert Gilbert, AZ 480-407-5800 mbgilbert.com/ 633 Customer Favorites	Vehicle sold
09/01/2022	340	Mercedes-Benz of Athens WATKINSVILLE, GA 855-651-0116 https://mercedesbenzofathens.com/ 12 Customer Favorites	Vehicle serviced -Fuel tank removed and reinstalled
10/25/2022		Oregon Motor Vehicle Dept.	Vehicle purchase reported -Titled or registered as commercial vehicle
10/26/2022		Oregon Motor Vehicle Dept. Ontario, OR Title #OR0004281478	Title issued or updated -Registration issued or renewed -First owner reported -Loan or lien reported

Ontario, OR
Title #OR0004281478

-First owner reported
-Loan or lien reported

12/12/2022

Damage Report

Accident reported: minor damage ⓘ

-Damage to right rear
-Airbags did not deploy

CARFAX HAS THE MOST ACCIDENT & DAMAGE INFORMATION

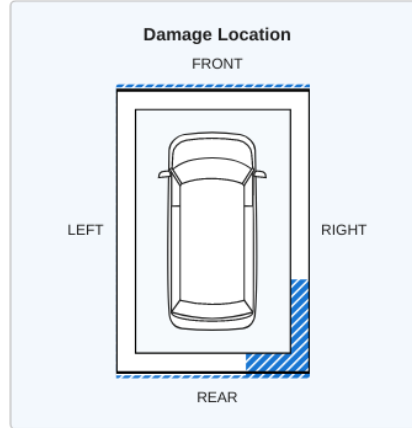
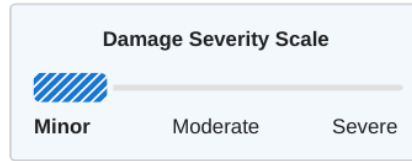

04/25/2023

Virginia
Motor Vehicle Dept.

Vehicle purchase reported

04/28/2023

Online Listing

Vehicle offered for sale

05/01/2023

16,350

Auto Auction

Vehicle sold

-Listed as a fleet/lease vehicle

05/16/2023

Virginia
Motor Vehicle Dept.
Denver, CO

Title issued or updated

-Dealer took title of this vehicle while it was in inventory

06/01/2023

16,370

Auto Auction

Vehicle sold

07/22/2023

Nesh Auto Sales
Decatur, GA
404-360-8643
neshautosales1.com/

Vehicle offered for sale

01/16/2024

16,612



Mercedes-Benz of Marietta
Marietta, GA
954-769-7000
mbmarietta.com

♥ 202 Customer Favorites

Vehicle serviced

-Maintenance inspection completed
-Battery/charging system checked
-Brakes checked
-Fuel pump module replaced
-Fuel pump replaced
-Fuel tank removed and reinstalled
-Tire condition and pressure checked



Owner 2

Purchased: 2024

Personal Vehicle

Date	Mileage	Source	Comments
------	---------	--------	----------

02/05/2024

Georgia
Motor Vehicle Dept.

Vehicle purchase reported

02/12/2024

Georgia
Motor Vehicle Dept.
Villa Rica, GA
Title #770184213058963



Title or registration issued

-New owner reported
-Loan or lien reported
-Vehicle color noted as White

**Owner 3**

Purchased: 2024







Personal Vehicle











Date	Mileage	Source	Comments
11/16/2024		Georgia Motor Vehicle Dept. Villa Rica, GA Title #770214294124980	Vehicle purchase reported - Title issued or updated - Registration issued or renewed - New owner reported - Loan or lien reported - Vehicle color noted as White
12/26/2024		Virginia Motor Vehicle Dept.	Vehicle purchase reported
02/17/2025	23,515	Virginia Motor Vehicle Dept. Winchester, VA	Title issued or updated - Vehicle repossessed
02/25/2025		Online Listing	Vehicle offered for sale
03/11/2025	23,594	Auto Auction	Vehicle sold
03/19/2025		South Carolina Motor Vehicle Dept.	Vehicle purchase reported
03/31/2025	23,599	Mercedes-Benz Vans Center - Baker Summerville, SC 843-377-1120 mbvanssummerville.com   1 Customer Favorite	Vehicle serviced - Battery replaced - Fuel injection system flushed/serviced - Hood prop rod replaced - Oil and filter changed - Safety inspection performed
04/18/2025		South Carolina Motor Vehicle Dept. Goose Creek, SC Title #772060484003258	Registration issued or renewed

**Owner 4**

Purchased: 2025

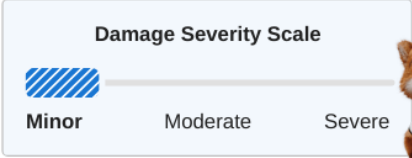
Personal Vehicle

Date	Mileage	Source	Comments
04/20/2025		South Carolina Motor Vehicle Dept. Goose Creek, SC Title #772060484003258	Title issued or updated - New owner reported - Loan or lien reported
06/21/2025	50,000	Pep Boys Cinnaminson, NJ 856-303-0300 pepboys.com   139 Customer Favorites	Vehicle serviced - Maintenance inspection completed - Alignment checked - Oil and filter changed - Tire(s) balanced - Tire(s) mounted - Tire(s) replaced
07/08/2025		East Commerce Automotive Lewisburg, TN 931-422-7063   40 Customer Favorites	Vehicle serviced - Battery replaced
09/13/2025	70,138	Midas Chillicothe, OH 740-775-2626 midas.com  	Vehicle serviced - Maintenance inspection completed

		740-775-2020 midas.com ♥ 54 Customer Favorites	
09/29/2025 	73,149	Valvoline Instant Oil Change Greenville, NC 252-317-2595 vioc.com ♥ 99 Customer Favorites	Vehicle serviced - Air filter replaced
10/13/2025 	78,137	Midas Bolingbrook, IL 630-739-5900 midas.com ♥ 972 Customer Favorites	Vehicle serviced - Spark plug(s) replaced
10/29/2025 	80,643	Mercedes-Benz of Farmington Farmington, UT 801-447-3300 mercedesfarmington.com ♥ 7,818 Customer Favorites	Vehicle serviced - Maintenance inspection completed - One tire balanced - One tire mounted - Tire(s) balanced - Tire(s) mounted
10/31/2025 	81,169	Valvoline Instant Oil Change Las Vegas, NV 725-231-1581 vioc.com ♥ 1 Customer Favorite	Vehicle serviced - Oil and filter changed
11/11/2025 		Damage Report	TOTAL LOSS VEHICLE - Vehicle declared a total loss by an insurance company
			There are many reasons an insurance company will declare a vehicle a total loss. Have this vehicle inspected by a qualified technician before you buy. Learn More
12/03/2025 	85,857	Mercedes-Benz of Romeoville Romeoville, IL 815-933-2100 mercedesbenzofbourbonnais.com ♥ 25 Customer Favorites	Vehicle serviced
01/27/2026		Damage Report	Damage reported: minor damage ⓘ
			 
02/21/2026 		Mercedes-Benz Vans Center - Baker Summerville, SC 843-377-1120 mbvanssummerville.com ♥ 1 Customer Favorite	Vehicle serviced - Maintenance inspection completed - Vehicle washed/detailed
03/17/2026		South Carolina Motor Vehicle Dept. Goose Creek, SC Title #772060484003258	Title issued or updated - Loan or lien released
03/31/2026 		Damage Report	SALVAGE TITLE/CERTIFICATE ISSUED

Accident Indicator

CARFAX receives information about accidents in all 50 states, the District of Columbia and Canada.

Not every accident is reported to CARFAX. As details about the accident become available, those additional details are added to the CARFAX Vehicle History Report. CARFAX recommends that you have this vehicle inspected by a qualified mechanic.

- According to the National Safety Council, Injury Facts, 2021 edition, 5% of the 276 million registered vehicles in the U.S. were involved in an accident in 2019. Over 77% of these were considered minor or moderate.
- This CARFAX Vehicle History Report is based only on information supplied to CARFAX and available as of 4/6/26 at 9:13:13 PM (CDT). Other information about this vehicle, including problems, may not have been reported to CARFAX. Use this report as one important tool, along with a vehicle inspection and test drive, to make a better decision about your next used car.

Commercial

Vehicle was registered for business purposes.

Damage Indicator

Damage can be a result of many different types of events. Examples include contact with objects (other cars, trees, traffic signs, road debris, etc), vandalism, or weather-related events. Not every damage event is reported to CARFAX. As details about the damage event become available, those additional details are added to the CARFAX Vehicle History Report. CARFAX recommends that you have this vehicle inspected by a qualified mechanic.

- This CARFAX Vehicle History Report is based only on information supplied to CARFAX and available as of 4/6/26 at 9:13:13 PM (CDT). Other information about this vehicle, including problems, may not have been reported to CARFAX. Use this report as one important tool, along with a vehicle inspection and test drive, to make a better decision about your next used car.

Damage Severity

Damage events result in one of the following severity levels:

- Minor: Generally, minor damage is cosmetic (including dents or scratches), may only require reconditioning, and typically does not compromise a vehicle's operation and/or safety.
- Moderate: Moderate damage may affect multiple components of the vehicle and may impair the vehicle's operation and/or safety.
- Severe: Severe damage usually affects multiple components of the vehicle and is likely to compromise the vehicle's operation and/or safety.

CARFAX recommends getting a pre-purchase inspection at a certified collision repair facility.

First Owner

When the first owner(s) obtains a title from a Department of Motor Vehicles as proof of ownership.

New Owner Reported

When a vehicle is sold to a new owner, the Title must be transferred to the new owner(s) at a Department of Motor Vehicles.

Ownership History

CARFAX defines an owner as an individual or business that possesses and uses a vehicle. Not all title transactions represent changes in ownership. To provide estimated number of owners, CARFAX proprietary technology analyzes all the events in a vehicle history. Estimated ownership is available for vehicles manufactured after 1991 and titled solely in the US including Puerto Rico. Dealers sometimes opt to take ownership of a vehicle and are required to in the following states: Maine, Massachusetts, New Jersey, Ohio, Oklahoma, Pennsylvania and South Dakota. Please consider this as you review a vehicle's estimated ownership history.

Repossession

When a repossession occurs a vehicle owner fails to make loan payments, and the financial institution holding the title takes possession of the vehicle.

Salvage Title

A Salvage Title is issued on a vehicle damaged to the extent that the cost of repairing the vehicle exceeds approximately 75% of its pre-damage value. This damage threshold may vary by state. Some states treat Junk titles the same as Salvage but the majority use this title to indicate that a vehicle is not road worthy and cannot be titled again in that state. The following eleven states also use Salvage titles to identify stolen vehicles - AZ, FL, GA, IL, MD, MN, NJ, NM, NY, OK and OR.

Title Issued

A state issues a title to provide a vehicle owner with proof of ownership. Each title has a unique number. Each title or registration record on a CARFAX report does not necessarily indicate a change in ownership. In Canada, a registration and bill of sale are used as proof of ownership.

Total Loss Vehicle

An insurance or fleet company declares a vehicle a total loss when a claim exceeds approximately 75% of its pre-damage value or if the vehicle is stolen and not recovered. This damage threshold varies by company. These companies typically take possession and obtain the title. Not all total loss vehicles result in a DMV-reported branded title. This may occur when an insurance company's definition of a total loss is different than the state DMV's definition for a branded title or when the owner of the vehicle is a self-insured company, like a fleet or rental company.

Follow
Us:



facebook.com/CARFAX



[@CARFAXinc](https://twitter.com/CARFAXinc)



[About CARFAX](#)

CARFAX DEPENDS ON ITS SOURCES FOR THE ACCURACY AND RELIABILITY OF ITS INFORMATION. THEREFORE, NO RESPONSIBILITY IS ASSUMED BY CARFAX OR ITS AGENTS FOR ERRORS OR OMISSIONS IN THIS REPORT. CARFAX FURTHER EXPRESSLY DISCLAIMS ALL WARRANTIES, EXPRESS OR IMPLIED, INCLUDING ANY IMPLIED WARRANTIES OF MERCHANTABILITY OR FITNESS FOR A PARTICULAR PURPOSE.

© 2026 CARFAX, Inc., part of S&P Global. All rights reserved.
4/6/26 9:13:13 PM (CDT)

I have reviewed and received a copy of the CARFAX Vehicle History Report for this 2022 MERCEDES-BENZ SPRINTER vehicle (VIN: W1W40CHY7NT103486), which is based on information supplied to CARFAX and available as of 4/6/26 at 10:13 PM (EDT).

Customer Signature

Date

Dealer Signature

Date