

**2023 Mercedes-Benz Metris Passenger**

18,472 mi | VIN: W1WV0FEY5P4362260

[Vehicle Details](#)

CARFAX HAS THE MOST ACCIDENT &amp; DAMAGE INFORMATION

**ACCIDENT**

Severe Damage

Minor

Moderate

Severe

**CARFAX VALUE** \$37,650

[Update Trim & Options](#)

Regular oil changes

CARFAX 1-Owner vehicle

Corporate vehicle

Last owned in California

22 Detailed records available

This CARFAX Vehicle History Report is based only on [information](#) supplied to CARFAX and available as of 3/21/26 at 1:27:02 AM (CDT). Other information about this vehicle, including problems, may not have been reported to CARFAX. Use this report as one important tool, along with a vehicle inspection and test drive, to make a better decision about your next used car.

**Accident / Damage History**

Not all accidents / issues are reported to CARFAX

## Event 1

06/29/2024

**Damage reported: minor damage**
[View More Details](#)
**Damage Severity Scale**

Minor

Moderate

Severe

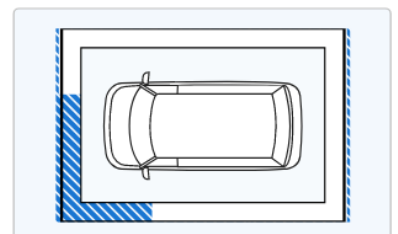

Event 2

07/04/2025

**Accident reported: severe damage** ⓘ

- Involving front or side impact with another motor vehicle
- Airbag deployed

[View More Details >](#)

Damage Severity Scale

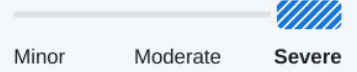

**CARFAX** History-Based Value Report

**\$37,650**

CARFAX Retail Value

History events affecting this vehicle's value

- ↑ 1 1-Owner Vehicle
- ↑ 🛢️ Regular Oil Changes
- ↓ ⚠️ Severe Damage
- ↓ ⚠️ Airbag Deployed

**CARFAX** Additional History

Not all accidents / issues are reported to CARFAX

👤 Owner 1

**Total Loss** ⓘ

No total loss reported to CARFAX.



**Structural Damage** ⓘ

CARFAX recommends that you have this vehicle inspected by a collision repair specialist.



**Airbag Deployment** ⓘ

Airbag deployment reported: 07/04/2025.

[Airbag Deployment](#)

**Odometer Check** ⓘ

No indication of an odometer rollback.



**Accident / Damage** ⓘ

Damage reported: 06/29/2024. Accident reported: 07/04/2025.

[Severe Damage](#)

**Manufacturer Recall** ⓘ

No open recalls reported to CARFAX.

No Recalls Reported

**Basic Warranty** ⓘ

[Original warranty](#) estimated to have 16 months or 17,528 miles remaining. Confirm with dealer or vehicle manufacturer.



**CARFAX** Title History

CARFAX guarantees the information in this section

👤 Owner 1

**Damage Brands** ⓘ

Salvage | Junk | Rebuilt | Fire | Flood | Hail | Lemon



**Odometer Brands** ⓘ

Not Actual Mileage | Exceeds Mechanical Limits



Odometer Brands | Exceeds Mechanical Limits



**GUARANTEED** - None of these title problems were reported by a U.S. state Department of Motor Vehicles (DMV). If you find that any of these title problems were reported by a DMV and not included in this report, you may qualify. [View Terms](#) | [View Certificate](#)



### Ownership History

The number of owners is estimated

Owner 1

Year purchased

2024

Type of owner

Corporate

Estimated length of ownership

1 yr. 8 mo.

Owned in the following states/provinces



California

Estimated miles driven per year

---

Last reported odometer reading

18,472



### Detailed History

[Glossary](#)

Owner 1

Purchased: 2024

Corporate Vehicle

Date	Mileage	Source	Comments
05/24/2024 	4	Keyes European Sherman Oaks, CA 800-852-1454 <a href="https://keyesmercedes.com">https://keyesmercedes.com</a> 15,627 Customer Favorites	<b>Vehicle serviced</b> -Pre-delivery inspection completed -Vehicle washed/detailed
06/15/2024 		Get Spiffy Inc Durham, NC 844-438-7743 <a href="https://getspiffy.com/">getspiffy.com/</a> 1 Customer Favorite	<b>Vehicle serviced</b> -Vehicle washed/detailed
06/26/2024		California Motor Vehicle Dept. Palmdale, CA	<b>Title issued or updated</b> -First owner reported -Titled or registered as corporate vehicle
06/27/2024 		Get Spiffy Inc Durham, NC 844-438-7743 <a href="https://getspiffy.com/">getspiffy.com/</a> 1 Customer Favorite	<b>Vehicle serviced</b> -Vehicle washed/detailed

06/29/2024

Damage Report

**Damage reported: minor damage** ⓘ

-Damage to left front  
-Damage to front



#### Damage Severity Scale



Minor

Moderate









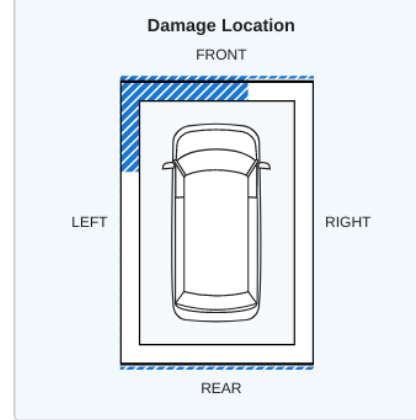









Severe

















#### Damage Location

FRONT

**CARFAX HAS THE MOST ACCIDENT & DAMAGE INFORMATION**



08/10/2024 		Get Spiffy Inc Durham, NC 844-438-7743 getspiffy.com/  1 Customer Favorite	<b>Vehicle serviced</b> - Vehicle washed/detailed
08/31/2024 		Get Spiffy Inc Durham, NC 844-438-7743 getspiffy.com/  1 Customer Favorite	<b>Vehicle serviced</b> - Vehicle washed/detailed
10/19/2024 	7,571	Keyes European Sherman Oaks, CA 800-852-1454 https://keyesmercedes.com  15,627 Customer Favorites	<b>Vehicle serviced</b> - Maintenance inspection completed - Body electrical system checked - Doors checked - Electrical system checked - Tire condition and pressure checked
10/24/2024 		Get Spiffy Inc Durham, NC 844-438-7743 getspiffy.com/  1 Customer Favorite	<b>Vehicle serviced</b> - Vehicle washed/detailed
10/31/2024 		Get Spiffy Inc Durham, NC 844-438-7743 getspiffy.com/  1 Customer Favorite	<b>Vehicle serviced</b> - Vehicle washed/detailed
11/12/2024 		Get Spiffy Inc Durham, NC 844-438-7743 getspiffy.com/  1 Customer Favorite	<b>Vehicle serviced</b> - Vehicle washed/detailed
11/24/2024 		Get Spiffy Inc Durham, NC 844-438-7743 getspiffy.com/  1 Customer Favorite	<b>Vehicle serviced</b> - Vehicle washed/detailed
12/04/2024 		Get Spiffy Inc Durham, NC 844-438-7743 getspiffy.com/  1 Customer Favorite	<b>Vehicle serviced</b> - Vehicle washed/detailed
12/21/2024 		Get Spiffy Inc Durham, NC 844-438-7743 getspiffy.com/  1 Customer Favorite	<b>Vehicle serviced</b> - Vehicle washed/detailed
01/04/2025 		Get Spiffy Inc Durham, NC 844-438-7743 getspiffy.com/  1 Customer Favorite	<b>Vehicle serviced</b> - Vehicle washed/detailed

01/04/2025 		Get Spiffy Inc Durham, NC 844-438-7743 getspiffy.com/  1 Customer Favorite	<b>Vehicle serviced</b> -Vehicle washed/detailed
01/17/2025 		Get Spiffy Inc Durham, NC 844-438-7743 getspiffy.com/  1 Customer Favorite	<b>Vehicle serviced</b> -Vehicle washed/detailed
01/29/2025 		Get Spiffy Inc Durham, NC 844-438-7743 getspiffy.com/  1 Customer Favorite	<b>Vehicle serviced</b> -Vehicle washed/detailed
02/16/2025 	16,772	Get Spiffy Inc Durham, NC 844-438-7743 getspiffy.com/  1 Customer Favorite	<b>Vehicle serviced</b> -Oil and filter changed -Vehicle washed/detailed
02/25/2025 		Get Spiffy Inc Durham, NC 844-438-7743 getspiffy.com/  1 Customer Favorite	<b>Vehicle serviced</b> -Vehicle washed/detailed
03/12/2025 	18,472	Keyes European Sherman Oaks, CA 800-852-1454 https://keyesmercedes.com  15,627 Customer Favorites	<b>Vehicle serviced</b> -Maintenance inspection completed -Electrical system checked -Tire condition and pressure checked
07/04/2025 		Damage Report	<b>Accident reported: severe damage</b> ⓘ -Involving front or side impact with another motor vehicle -Airbag deployed <a href="#">CARFAX Airbag Tips</a>
<div data-bbox="906 1339 1321 1496"> <p><b>Damage Severity Scale</b></p> <p>Minor      Moderate      <b>Severe</b></p> </div> 			
03/16/2026		California Motor Vehicle Dept. Palmdale, CA	<b>Title issued or updated</b> -Loan or lien reported
 <div data-bbox="839 1659 1493 1765" style="border: 1px solid blue; padding: 5px;"> <p>Avoid financial headaches. Make sure the loan has been paid off if you're buying from a private seller. <a href="#">Learn More</a></p> </div>			
 <div data-bbox="320 1794 1501 1921" style="border: 1px solid blue; padding: 10px;"> <p>This vehicle's oil change history, as reported to CARFAX, follows the manufacturer's recommendation. Track your service history for free at <a href="https://carfax.com/service">carfax.com/service</a>.</p> </div>			

Have Questions? Consumers, please visit our Help Center at [www.carfax.com](http://www.carfax.com). Dealers or Subscribers, please visit our Help Center at [www.carfaxonline.com](http://www.carfaxonline.com).

### Accident Indicator

CARFAX receives information about accidents in all 50 states, the District of Columbia and Canada.

Not every accident is reported to CARFAX. As details about the accident become available, those additional details are added to the CARFAX Vehicle History Report. CARFAX recommends that you have this vehicle inspected by a qualified mechanic.

- According to the National Safety Council, Injury Facts, 2021 edition, 5% of the 276 million registered vehicles in the U.S. were involved in an accident in 2019. Over 77% of these were considered minor or moderate.
- This CARFAX Vehicle History Report is based only on information supplied to CARFAX and available as of 3/21/26 at 1:27:02 AM (CDT). Other information about this vehicle, including problems, may not have been reported to CARFAX. Use this report as one important tool, along with a vehicle inspection and test drive, to make a better decision about your next used car.

### Airbag Deployment

Occurs when the driver, passenger or side airbag has been used or deployed during a crash or other incident. If an airbag has been deployed, it must be replaced by a qualified technician. Have this car inspected by a mechanic prior to purchase.

### CARFAX Well Maintained - Regular Oil Changes

CARFAX identifies a "Well Maintained - Regular Oil Change" vehicle as having a regular oil change history when all its recommended oil changes, based on the vehicle's maintenance schedule, have been reported to CARFAX. CARFAX uses the manufacturer's schedule and assumes normal driving conditions. When an oil change schedule is not available, CARFAX may analyze reported service events to determine what is typical for the same make and model vehicle. Dealers and service shops may publish different recommended service schedules.

### Damage Indicator

Damage can be a result of many different types of events. Examples include contact with objects (other cars, trees, traffic signs, road debris, etc), vandalism, or weather-related events. Not every damage event is reported to CARFAX. As details about the damage event become available, those additional details are added to the CARFAX Vehicle History Report. CARFAX recommends that you have this vehicle inspected by a qualified mechanic.

- This CARFAX Vehicle History Report is based only on information supplied to CARFAX and available as of 3/21/26 at 1:27:02 AM (CDT). Other information about this vehicle, including problems, may not have been reported to CARFAX. Use this report as one important tool, along with a vehicle inspection and test drive, to make a better decision about your next used car.

### Damage Severity

Damage events result in one of the following severity levels:

- Minor: Generally, minor damage is cosmetic (including dents or scratches), may only require reconditioning, and typically does not compromise a vehicle's operation and/or safety.
- Moderate: Moderate damage may affect multiple components of the vehicle and may impair the vehicle's operation and/or safety.
- Severe: Severe damage usually affects multiple components of the vehicle and is likely to compromise the vehicle's operation and/or safety.

CARFAX recommends getting a pre-purchase inspection at a certified collision repair facility.

### First Owner

When the first owner(s) obtains a title from a Department of Motor Vehicles as proof of ownership.

### Ownership History

CARFAX defines an owner as an individual or business that possesses and uses a vehicle. Not all title transactions represent changes in ownership. To provide estimated number of owners, CARFAX proprietary technology analyzes all the events in a vehicle history. Estimated ownership is available for vehicles manufactured after 1991 and titled solely in the US including Puerto Rico. Dealers sometimes opt to take ownership of a vehicle and are required to in the following states: Maine, Massachusetts, New Jersey, Ohio, Oklahoma, Pennsylvania and South Dakota. Please consider this as you review a vehicle's estimated ownership history.

### Title Issued

A state issues a title to provide a vehicle owner with proof of ownership. Each title has a unique number. Each title or registration record on a CARFAX report does not necessarily indicate a change in ownership. In Canada, a registration and bill of sale are used as proof of ownership.

Follow  
Us:



[facebook.com/CARFAX](https://facebook.com/CARFAX)



[@CARFAXinc](https://twitter.com/CARFAXinc)



[About CARFAX](#)

CARFAX DEPENDS ON ITS SOURCES FOR THE ACCURACY AND RELIABILITY OF ITS INFORMATION. THEREFORE, NO RESPONSIBILITY IS ASSUMED BY CARFAX OR ITS AGENTS FOR ERRORS OR OMISSIONS IN THIS REPORT. CARFAX FURTHER EXPRESSLY DISCLAIMS ALL WARRANTIES, EXPRESS OR IMPLIED, INCLUDING ANY IMPLIED WARRANTIES OF MERCHANTABILITY OR FITNESS FOR A PARTICULAR PURPOSE.

© 2026 CARFAX, Inc., part of S&P Global. All rights reserved.  
3/21/26 1:27:02 AM (CDT)

I have reviewed and received a copy of the CARFAX Vehicle History Report for this 2023 MERCEDES-BENZ METRIS vehicle (VIN: W1WV0FEY5P4362260), which is based on information supplied to CARFAX and available as of 3/21/26 at 2:27 AM (EDT).

Customer Signature

Date

Dealer Signature

Date

Customer Signature

Date

Dealer Signature

Date