

History-Based Value Report

\$18,400

CARFAX Retail Value

History events affecting this vehicle's value

- 1-Owner Vehicle
- Service History
- Salvage Brand
- Open Recall

Vehicle History Report™

US \$44.99

2022 MERCEDES-BENZ METRIS CARGO

VIN: W1YV0BEY2N3957540
 CARGO VAN
 2.0L I4
 GASOLINE
 REAR WHEEL DRIVE

Branded Title: Salvage >

10 Service history records >

At least 1 open recall >

CARFAX 1-Owner vehicle >

Corporate vehicle >

Last owned in Florida >

This CARFAX Vehicle History Report is based only on [information](#) supplied to CARFAX and available as of 1/21/26 at 12:07:32 PM (CST). Other information about this vehicle, including problems, may not have been reported to CARFAX. Use this report as one important tool, along with a vehicle inspection and test drive, to make a better decision about your next used car.

Accident / Damage History

Not all accidents / issues are reported to CARFAX

Event 1

09/13/2025

Accident reported

- Disabling damage reported
- Airbags did not deploy

[View More Details >](#)

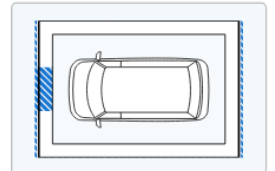

Event 2

09/13/2025



TOTAL LOSS VEHICLE

- Vehicle declared a total loss by an insurance company
- Collision damage reported

[View More Details >](#)

CARFAX Recent Service Highlights

Key services performed in the last 12 months

Service	Comments	Date	
 Oil	 Oil and filter changed	06/06/2025	View Details >



This car has been recently serviced. That's a good thing!

CARFAX Additional History

Not all accidents / issues are reported to CARFAX

 Owner 1

Total Loss

Total Loss Reported: 09/13/2025.

[Total Loss Reported](#)

Structural Damage

CARFAX recommends that you have this vehicle inspected by a collision repair specialist.

 No Issues Reported

Airbag Deployment

No airbag deployment reported to CARFAX.

 No Issues Reported

Odometer Check

Inconsistent mileage indicated.

[Mileage Inconsistency](#)

Accident / Damage

DMV title problems reported. Accident reported: 09/13/2025.

[Severe Damage](#)

Manufacturer Recall

At least 1 manufacturer recall requires repair. Most recalls can be repaired free of charge.

[Recall Reported](#)

Basic Warranty

Original manufacturer warranty likely voided by manufacturer.

Warranty Voided

CARFAX Title History

 Owner 1

Damage Brands

Salvage | Junk | Rebuilt | Fire | Flood | Hail | Lemon

Alert!
Problem Found

Odometer Brands

Not Actual Mileage | Exceeds Mechanical Limits

No Problem

 **ALERT!** - Severe problems were reported by a state Department of Motor Vehicles (DMV). This vehicle does not qualify for the CARFAX Buyback Guarantee.

CARFAX Ownership History

The number of owners is estimated

 Owner 1

Year purchased

2023

Type of owner

Corporate

Estimated length of ownership

2 yrs. 3 mo.

Owned in the following states/provinces

Florida

Estimated miles driven per year

??

Estimated miles driven per year

Last reported odometer reading















 Detailed History

[Glossary](#)

Owner 1

Purchased: 2023









Corporate Vehicle

Date	Mileage	Source		Comments
04/11/2022	8	Mercedes-Benz of Hoffman Estates Hoffman Estates, IL 847-885-7000 mercedeshoffman.com  7,632 Customer Favorites		Vehicle serviced -Pre-delivery inspection completed
06/20/2022	9,283	Mercedes-Benz of Hoffman Estates Hoffman Estates, IL 847-885-7000 mercedeshoffman.com  7,632 Customer Favorites		Vehicle serviced -Oil and filter changed
07/21/2022	10,369	Mercedes-Benz of Hoffman Estates Hoffman Estates, IL 847-885-7000 mercedeshoffman.com  7,632 Customer Favorites		Vehicle serviced -Maintenance inspection completed -Electrical system checked -Engine checked
08/09/2022	10,797	Mercedes-Benz of Hoffman Estates Hoffman Estates, IL 847-885-7000 mercedeshoffman.com  7,632 Customer Favorites		Vehicle serviced -Maintenance inspection completed -Electrical system checked -Fuel system checked -Fuel pump module replaced -Fuel pump replaced -Fuel tank drained and cleaned -Fuel tank removed and reinstalled
02/23/2023	22,636	Mercedes-Benz of Hoffman Estates Hoffman Estates, IL 847-885-7000 mercedeshoffman.com  7,632 Customer Favorites		Vehicle serviced -Air filter replaced -Cabin air filter replaced/cleaned -Oil and filter changed -One tire replaced
07/31/2023	35,796	Mercedes-Benz of Hoffman Estates Hoffman Estates, IL 847-885-7000 mercedeshoffman.com  7,632 Customer Favorites		Vehicle serviced -Maintenance inspection completed -Oil and filter changed -Tire(s) replaced -Two tires replaced
09/29/2023	39,083	Mercedes-Benz of Hoffman Estates Hoffman Estates, IL 847-885-7000 mercedeshoffman.com  7,632 Customer Favorites		Vehicle serviced -Pre-delivery inspection completed -Maintenance inspection completed -Brakes checked -One tire replaced -Trim checked
10/02/2023		Florida Motor Vehicle Dept.		Vehicle purchase reported -Titled or registered as corporate vehicle
11/20/2023		Florida Motor Vehicle Dept. Miami, FL Title #0152839947		Title issued or updated -Registration issued or renewed -First owner reported -Loan or lien reported -Vehicle color noted as White
12/22/2023		Mercedes-Benz USA LLC		Manufacturer Safety recall issued -NHTSA #23V444 -Recall #2023100006 Status/Remarks Available

-NHTSA #23V444
-Recall #2023100006
-Status: Remedy Available

[Click here](#) or call 1-800-367-6372 to locate an authorized Mercedes-Benz dealer near you to obtain more information about this recall

[+ Learn more about this recall](#)

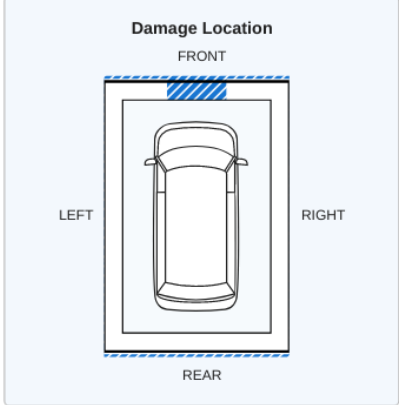
01/18/2024		Florida Motor Vehicle Dept. Miami Beach, FL Title #0152839947		Registration issued or renewed -Loan or lien reported -Registration updated when owner moved the vehicle to a new location -Vehicle color noted as White
06/28/2024		Florida Motor Vehicle Dept. Miami Beach, FL Title #0152839947		Registration issued or renewed -Loan or lien reported -Vehicle color noted as White
11/22/2024		Express Oil Change & Tire Engineers Roswell, GA 770-642-0133  6 Customer Favorites		Vehicle serviced -Maintenance inspection completed -Brake pads replaced -Brake rotor(s) replaced -Four tires balanced -Four tires mounted -Four tires replaced -Front brake pads replaced -Front brakes serviced -Oil and filter changed -Rear brake pads replaced -Tire condition and pressure checked -Tire repaired -Tire(s) balanced -Tire(s) mounted -Tire(s) replaced -Tires rotated
04/22/2025	76,494	Express Oil Change & Tire Engineers Roswell, GA 770-642-0133  6 Customer Favorites		Vehicle serviced -Maintenance inspection completed -Brake light bulb(s) replaced -Light bulb(s) replaced -Oil and filter changed
06/06/2025	82,084	Andrews Auto Repair Monroe, GA 770-342-9448  6 Customer Favorites		Vehicle serviced -Oil and filter changed
09/13/2025		Damage Report		Accident reported -Damage to front -Disabling damage reported -Airbags did not deploy
				

CARFAX HAS THE MOST ACCIDENT & DAMAGE INFORMATION

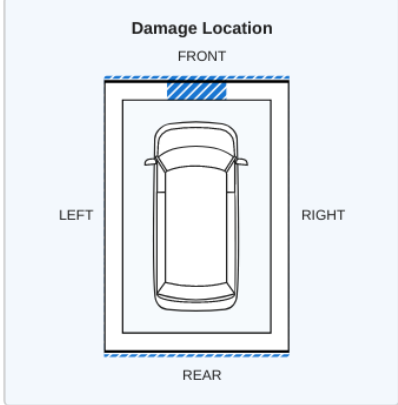



09/13/2025		Damage Report		TOTAL LOSS VEHICLE -Vehicle declared a total loss by an insurance company -Collision damage reported
------------	--	---------------	---	---



There are many reasons an insurance company will declare a vehicle a total loss. Have this vehicle inspected by a qualified technician before you buy. [Learn More](#)



vehicle a total loss. Have this vehicle inspected by a qualified technician before you buy. [Learn More](#)

10/21/2025	Mercedes-Benz USA LLC	Manufacturer Safety recall issued -NHTSA #25V463 -Recall #2025090006 -Status: Remedy Available
		Click here or call 1-800-367-6372 to locate an authorized Mercedes-Benz dealer near you to obtain more information about this recall
		+ Learn more about this recall
12/23/2025	Florida Motor Vehicle Dept. Miami Beach, FL Title #0152839947	Registration issued or renewed -Vehicle color noted as White
01/12/2026	62,083 Florida Motor Vehicle Dept. Acworth, GA	Odometer reading reported MILEAGE INCONSISTENCY
		 The mileage reported here conflicts with this vehicle's odometer history. Ask a mechanic or the seller to confirm the actual mileage - this entry may just be a clerical error.
01/13/2026	Florida Motor Vehicle Dept.	Title or registration issued to insurance company
01/13/2026	Florida Motor Vehicle Dept. Acworth, GA Title #0152839947	 SALVAGE TITLE/CERTIFICATE ISSUED -Vehicle color noted as White
01/15/2026	Damage Report	 SALVAGE TITLE/CERTIFICATE ISSUED

Have Questions? Consumers, please visit our Help Center at www.carfax.com. Dealers or Subscribers, please visit our Help Center at www.carfaxonline.com.

CARFAX Glossary

[Full Glossary](#)

Accident Indicator

CARFAX receives information about accidents in all 50 states, the District of Columbia and Canada.

Not every accident is reported to CARFAX. As details about the accident become available, those additional details are added to the CARFAX Vehicle History Report. CARFAX recommends that you have this vehicle inspected by a qualified mechanic.

- According to the National Safety Council, Injury Facts, 2021 edition, 5% of the 276 million registered vehicles in the U.S. were involved in an accident in 2019. Over 77% of these were considered minor or moderate.
- This CARFAX Vehicle History Report is based only on information supplied to CARFAX and available as of 1/21/26 at 12:07:32 PM (CST). Other information about this vehicle, including problems, may not have been reported to CARFAX. Use this report as one important tool, along with a vehicle inspection and test drive, to make a better decision about your next used car.

Damage Indicator

Damage can be a result of many different types of events. Examples include contact with objects (other cars, trees, traffic signs, road debris, etc), vandalism, or weather-related events. Not every damage event is reported to CARFAX. As details about the damage event become available, those additional details are added to the CARFAX Vehicle History Report. CARFAX recommends that you have this vehicle inspected by a qualified mechanic.

- This CARFAX Vehicle History Report is based only on information supplied to CARFAX and available as of 1/21/26 at 12:07:32 PM (CST). Other information about this vehicle, including problems, may not have been reported to CARFAX. Use this report as one important tool, along with a vehicle inspection and test drive, to make a better decision about your next used car.

First Owner

When the first owner(s) obtains a title from a Department of Motor Vehicles as proof of ownership.

Manufacturer Recall

Automobile manufacturers issue recall notices to inform vehicle owners of a safety defect or failure to meet minimum federal safety or emissions standards. Manufacturer recalls are repaired at no cost to the customer.

Mileage Inconsistency

If an odometer reading is less than a previous reading but CARFAX is uncertain whether the discrepancy is a rollback or a clerical error, then CARFAX calls it a

Mileage Inconsistency

If an odometer reading is less than a previous reading but CARFAX is uncertain whether the discrepancy is a rollback or a clerical error, then CARFAX calls it a "Mileage Inconsistency". In this case, you should verify the mileage with your dealer or a qualified mechanic.

Ownership History

CARFAX defines an owner as an individual or business that possesses and uses a vehicle. Not all title transactions represent changes in ownership. To provide estimated number of owners, CARFAX proprietary technology analyzes all the events in a vehicle history. Estimated ownership is available for vehicles manufactured after 1991 and titled solely in the US including Puerto Rico. Dealers sometimes opt to take ownership of a vehicle and are required to in the following states: Maine, Massachusetts, New Jersey, Ohio, Oklahoma, Pennsylvania and South Dakota. Please consider this as you review a vehicle's estimated ownership history.

Salvage Title

A Salvage Title is issued on a vehicle damaged to the extent that the cost of repairing the vehicle exceeds approximately 75% of its pre-damage value. This damage threshold may vary by state. Some states treat Junk titles the same as Salvage but the majority use this title to indicate that a vehicle is not road worthy and cannot be titled again in that state. The following eleven states also use Salvage titles to identify stolen vehicles - AZ, FL, GA, IL, MD, MN, NJ, NM, NY, OK and OR.

Title Issued

A state issues a title to provide a vehicle owner with proof of ownership. Each title has a unique number. Each title or registration record on a CARFAX report does not necessarily indicate a change in ownership. In Canada, a registration and bill of sale are used as proof of ownership.

Total Loss Vehicle

An insurance or fleet company declares a vehicle a total loss when a claim exceeds approximately 75% of its pre-damage value or if the vehicle is stolen and not recovered. This damage threshold varies by company. These companies typically take possession and obtain the title. Not all total loss vehicles result in a DMV-reported branded title. This may occur when an insurance company's definition of a total loss is different than the state DMV's definition for a branded title or when the owner of the vehicle is a self-insured company, like a fleet or rental company.

Follow
Us:



facebook.com/CARFAX



[@CARFAXinc](https://twitter.com/CARFAXinc)



[About CARFAX](#)

CARFAX DEPENDS ON ITS SOURCES FOR THE ACCURACY AND RELIABILITY OF ITS INFORMATION. THEREFORE, NO RESPONSIBILITY IS ASSUMED BY CARFAX OR ITS AGENTS FOR ERRORS OR OMISSIONS IN THIS REPORT. CARFAX FURTHER EXPRESSLY DISCLAIMS ALL WARRANTIES, EXPRESS OR IMPLIED, INCLUDING ANY IMPLIED WARRANTIES OF MERCHANTABILITY OR FITNESS FOR A PARTICULAR PURPOSE.

© 2026 CARFAX, Inc., part of S&P Global. All rights reserved.
1/21/26 12:07:32 PM (CST)

I have reviewed and received a copy of the CARFAX Vehicle History Report for this 2022 MERCEDES-BENZ METRIS vehicle (VIN: W1YV0BEY2N3957540), which is based on information supplied to CARFAX and available as of 1/21/26 at 1:07 PM (EST).

Customer Signature

Date

Dealer Signature

Date