

CARFAX History-Based Value Report

[Hide](#)

\$22,870

CARFAX Retail Value

Retail Wholesale

History events affecting this vehicle's value

- 1-Owner Vehicle
- Regular Oil Changes
- Personal Vehicle
- Salvage Brand

CARFAX Vehicle History Report™

US \$44.99

2023 AUDI Q5 QUATTRO PREMIUM 40 TFSI

VIN: WA1ABAFY0P2193566
4 DOOR WAGON/SPORT UTILITY
2.0L I4
GASOLINE
ALL WHEEL DRIVE

Branded Title: Salvage >

Regular oil changes >

CARFAX 1-Owner vehicle >

Personal vehicle >

Last owned in California >

35,478 Last reported odometer reading >

CARFAX HAS THE MOST ACCIDENT & DAMAGE INFORMATION



This CARFAX Vehicle History Report is based only on [information](#) supplied to CARFAX and available as of 5/24/25 at 3:15:03 AM (CDT). Other information about this vehicle, including problems, may not have been reported to CARFAX. Use this report as one important tool, along with a vehicle inspection and test drive, to make a better decision about your next used car.

CARFAX Accident / Damage History

Not all accidents / issues are reported to CARFAX

Event 1

02/06/2025

Damage reported: minor damage

[View More Details >](#)

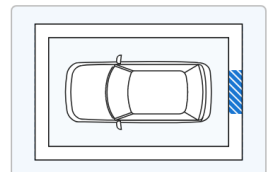
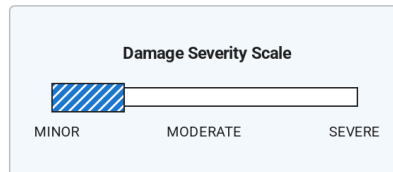

Event 2

02/28/2025

Accident reported: moderate damage

- Airbags did not deploy

[View More Details >](#)

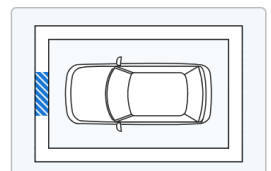
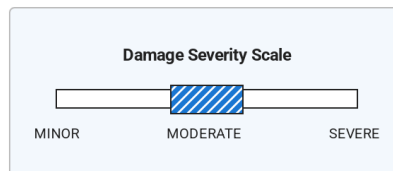

Event 3

02/28/2025

02/28/2025

TOTAL LOSS VEHICLE

- Vehicle declared a total loss by an insurance company
- Collision damage reported

[View More Details >](#)

CARFAX Recent Service Highlights

Key services performed in the last 12 months

| Service | Comments | Date | |
|---------|--|------------|-----------------------------------|
| Oil | ✓ Oil and filter changed | 12/12/2024 | View Details > |
| Tires | ✓ Tire(s) replaced ✓ Two tires replaced | 07/25/2024 | View Details > |
| Brakes | ✓ Brake fluid flushed/changed | 12/12/2024 | View Details > |



This car has been recently serviced. That's a good thing!

CARFAX Additional History

Not all accidents / issues are reported to CARFAX

Owner 1

Total Loss ⓘ

Total Loss Reported: 02/28/2025.

[Total Loss Reported](#)

Structural Damage ⓘ

CARFAX recommends that you have this vehicle inspected by a collision repair specialist.

✓ No Issues Reported

Airbag Deployment ⓘ

No airbag deployment reported to CARFAX.

✓ No Issues Reported

Odometer Check ⓘ

No indication of an odometer rollback.

✓ No Issues Indicated

Accident / Damage ⓘ

DMV title problems reported. Damage reported: 02/06/2025. Accident reported: 02/28/2025.

[Severe Damage](#)

Manufacturer Recall ⓘ

No open recalls reported to CARFAX.

✓ No Recalls Reported

Basic Warranty ⓘ

Original manufacturer warranty likely voided by manufacturer.

Warranty Voided

CARFAX Title History

Owner 1

Damage Brands ⓘ

Salvage | Junk | Rebuilt | Fire | Flood | Hail | Lemon

Alert!
Problem Found

Odometer Brands ⓘ

Not Actual Mileage | Exceeds Mechanical Limits

No Problem



ALERT! - Severe problems were reported by a state Department of Motor Vehicles (DMV). This vehicle does not qualify for the CARFAX Buyback Guarantee.

ALERT: Severe problems were reported by a state Department of Motor Vehicles (DMV). This vehicle does not qualify for the CARFAX Buyback Guarantee.



Ownership History

The number of owners is estimated

Owner 1

Year purchased

2023

Type of owner

Personal

Estimated length of ownership

1 yr. 8 mo.

Owned in the following states/provinces

California

Estimated miles driven per year

21,690/yr

Last reported odometer reading

35,478



Detailed History



[Glossary](#)

Owner 1

Purchased: 2023

Personal Vehicle

21,690 mi/yr

| Date | Mileage | Source | Comments |
|--------------|---------|---|--|
| Not Reported | | NICB | Vehicle manufactured and shipped to California |
| 08/11/2023 | 12 | Audi Pasadena Pasadena, CA 626-449-0770 audipasadena.com/ ★ 4.7 / 5.0 50 Verified Reviews ✓ ♥ 1,958 Customer Favorites |  Vehicle serviced - Pre-delivery inspection completed - Tire condition and pressure checked |
| 08/23/2023 | | Audi Pasadena Pasadena, CA 626-449-0770 audipasadena.com/ ★ 4.7 / 5.0 50 Verified Reviews ✓ ♥ 1,958 Customer Favorites | Vehicle offered for sale |
| 09/10/2023 | 27 | California Motor Vehicle Dept. San Marino, CA | Odometer reading reported |
| 09/11/2023 | | Audi Pasadena Pasadena, CA 626-449-0770 audipasadena.com/ ★ 4.7 / 5.0 50 Verified Reviews ✓ ♥ 1,958 Customer Favorites | Vehicle sold |
| 09/26/2023 | | California Motor Vehicle Dept. San Marino, CA | Title issued or updated - First owner reported - Titled or registered as personal vehicle - Loan or lien reported |
| 03/27/2024 | 11,531 | Audi Pasadena Pasadena, CA 626-449-0770 audipasadena.com/ ★ 4.7 / 5.0 50 Verified Reviews ✓ ♥ 1,958 Customer Favorites |  Vehicle serviced - Maintenance inspection completed - 10,000 mile service performed - Oil and filter changed - Tire condition and pressure checked |

★ 4.7 / 5.0 [50 Verified Reviews](#) ✓
♥ 1,958 Customer Favorites

05/15/2024 13,357

Audi Pasadena
Pasadena, CA
626-449-0770
audipasadena.com/

★ 4.7 / 5.0 [50 Verified Reviews](#) ✓

♥ 1,958 Customer Favorites



Vehicle serviced

- Maintenance inspection completed
- Computer reprogrammed
- Tire condition and pressure checked
- Transmission computer/module reprogrammed

07/25/2024 20,944

Audi Pasadena
Pasadena, CA
626-449-0770
audipasadena.com/

★ 4.7 / 5.0 [50 Verified Reviews](#) ✓

♥ 1,958 Customer Favorites



Vehicle serviced

- Maintenance inspection completed
- 20,000 mile service performed
- Brakes checked
- Brake fluid flushed/changed
- Oil and filter changed
- Tire condition and pressure checked
- Tire(s) replaced
- Two tires replaced

10/27/2024 27,932

Big Brand Tire
Rosemead, CA
626-288-8662
bigbrandtire.com

★ 4.6 / 5.0 [46 Verified Reviews](#) ✓

♥ 6 Customer Favorites



Vehicle serviced

- Tire(s) balanced

12/12/2024 31,150

Audi Pasadena
Pasadena, CA
626-449-0770
audipasadena.com/

★ 4.7 / 5.0 [50 Verified Reviews](#) ✓

♥ 1,958 Customer Favorites



Vehicle serviced

- Maintenance inspection completed
- 30,000 mile service performed
- Brakes checked
- Brake fluid flushed/changed
- Oil and filter changed
- Tire condition and pressure checked

02/06/2025

Damage Report



Damage reported: minor damage ⓘ

- Damage to rear

**CARFAX HAS THE MOST
ACCIDENT & DAMAGE
INFORMATION**

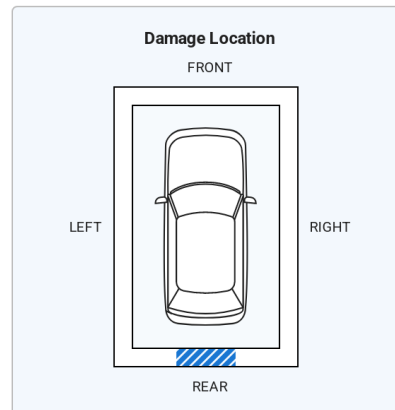
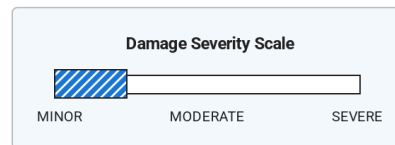

02/28/2025

Damage Report



Accident reported: moderate damage ⓘ

- Damage to front
- Airbags did not deploy

**CARFAX HAS THE MOST
ACCIDENT & DAMAGE
INFORMATION**

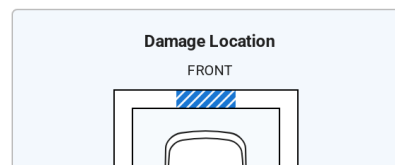
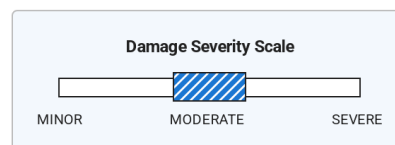

ACCIDENT & DAMAGE INFORMATION

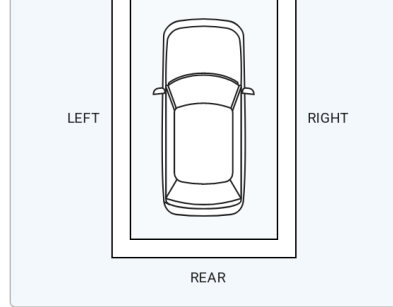

| | | | | |
|------------|--------|---|--|---|
| 02/28/2025 | | Damage Report | | TOTAL LOSS VEHICLE - Vehicle declared a total loss by an insurance company - Collision damage reported |
| | | | | There are many reasons an insurance company will declare a vehicle a total loss. Have this vehicle inspected by a qualified technician before you buy. Learn More |
| 05/01/2025 | | California Motor Vehicle Dept. San Marino, CA | | Title issued or updated - Loan or lien reported |
| 05/15/2025 | | California Motor Vehicle Dept. | | Title or registration issued to insurance company |
| 05/15/2025 | 35,478 | California Motor Vehicle Dept. Gardena, CA | | SALVAGE TITLE/CERTIFICATE ISSUED |
| 05/16/2025 | | Damage Report | | SALVAGE TITLE/CERTIFICATE ISSUED |
| 05/24/2025 | | Audi | | Connect Service available with subscription Connect offers services to enhance navigation, infotainment, and peace of mind Learn more |
| | | | | This vehicle's oil change history, as reported to CARFAX, follows the manufacturer's recommendation. Track your service history for free at carfax.com/service . |

Have Questions? Consumers, please visit our Help Center at www.carfax.com. Dealers or Subscribers, please visit our Help Center at www.carfaxonline.com.

Accident Indicator

CARFAX receives information about accidents in all 50 states, the District of Columbia and Canada.

Not every accident is reported to CARFAX. As details about the accident become available, those additional details are added to the CARFAX Vehicle History Report. CARFAX recommends that you have this vehicle inspected by a qualified mechanic.

- According to the National Safety Council, Injury Facts, 2021 edition, 5% of the 276 million registered vehicles in the U.S. were involved in an accident in 2019. Over 77% of these were considered minor or moderate.
- This CARFAX Vehicle History Report is based only on information supplied to CARFAX and available as of 5/24/25 at 3:15:03 AM (CDT). Other information about this vehicle, including problems, may not have been reported to CARFAX. Use this report as one important tool, along with a vehicle inspection and test drive, to make a better decision about your next used car.

CARFAX Well Maintained - Regular Oil Changes

CARFAX identifies a "Well Maintained - Regular Oil Change" vehicle as having a regular oil change history when all its recommended oil changes, based on the vehicle's maintenance schedule, have been reported to CARFAX. CARFAX uses the manufacturer's schedule and assumes normal driving conditions. When an oil change schedule is not available, CARFAX may analyze reported service events to determine what is typical for the same make and model vehicle. Dealers and service shops may publish different recommended service schedules.

Damage Indicator

Damage can be a result of many different types of events. Examples include contact with objects (other cars, trees, traffic signs, road debris, etc), vandalism, or weather-related events. Not every damage event is reported to CARFAX. As details about the damage event become available, those additional details are added to the CARFAX

Damage can be a result of many different types of events. Examples include contact with objects (other cars, trees, traffic signs, road debris, etc), vandalism, or weather-related events. Not every damage event is reported to CARFAX. As details about the damage event become available, those additional details are added to the CARFAX Vehicle History Report. CARFAX recommends that you have this vehicle inspected by a qualified mechanic.

- This CARFAX Vehicle History Report is based only on information supplied to CARFAX and available as of 5/24/25 at 3:15:03 AM (CDT). Other information about this vehicle, including problems, may not have been reported to CARFAX. Use this report as one important tool, along with a vehicle inspection and test drive, to make a better decision about your next used car.

Damage Severity

Damage events result in one of the following severity levels:

- Minor: Generally, minor damage is cosmetic (including dents or scratches), may only require reconditioning, and typically does not compromise a vehicle's operation and/or safety.
- Moderate: Moderate damage may affect multiple components of the vehicle and may impair the vehicle's operation and/or safety.
- Severe: Severe damage usually affects multiple components of the vehicle and is likely to compromise the vehicle's operation and/or safety.

CARFAX recommends getting a pre-purchase inspection at a certified collision repair facility.

First Owner

When the first owner(s) obtains a title from a Department of Motor Vehicles as proof of ownership.

Ownership History

CARFAX defines an owner as an individual or business that possesses and uses a vehicle. Not all title transactions represent changes in ownership. To provide estimated number of owners, CARFAX proprietary technology analyzes all the events in a vehicle history. Estimated ownership is available for vehicles manufactured after 1991 and titled solely in the US including Puerto Rico. Dealers sometimes opt to take ownership of a vehicle and are required to in the following states: Maine, Massachusetts, New Jersey, Ohio, Oklahoma, Pennsylvania and South Dakota. Please consider this as you review a vehicle's estimated ownership history.

Salvage Title



A Salvage Title is issued on a vehicle damaged to the extent that the cost of repairing the vehicle exceeds approximately 75% of its pre-damage value. This damage threshold may vary by state. Some states treat Junk titles the same as Salvage but the majority use this title to indicate that a vehicle is not road worthy and cannot be titled again in that state. The following eleven states also use Salvage titles to identify stolen vehicles - AZ, FL, GA, IL, MD, MN, NJ, NM, NY, OK and OR.

Title Issued

A state issues a title to provide a vehicle owner with proof of ownership. Each title has a unique number. Each title or registration record on a CARFAX report does not necessarily indicate a change in ownership. In Canada, a registration and bill of sale are used as proof of ownership.

Total Loss Vehicle

An insurance or fleet company declares a vehicle a total loss when a claim exceeds approximately 75% of its pre-damage value or if the vehicle is stolen and not recovered. This damage threshold varies by company. These companies typically take possession and obtain the title. Not all total loss vehicles result in a DMV-reported branded title. This may occur when an insurance company's definition of a total loss is different than the state DMV's definition for a branded title or when the owner of the vehicle is a self-insured company, like a fleet or rental company.

Follow Us:  facebook.com/CARFAX  [@CARFAXinc](https://twitter.com/CARFAXinc)  [About CARFAX](#)

CARFAX DEPENDS ON ITS SOURCES FOR THE ACCURACY AND RELIABILITY OF ITS INFORMATION. THEREFORE, NO RESPONSIBILITY IS ASSUMED BY CARFAX OR ITS AGENTS FOR ERRORS OR OMISSIONS IN THIS REPORT. CARFAX FURTHER EXPRESSLY DISCLAIMS ALL WARRANTIES, EXPRESS OR IMPLIED, INCLUDING ANY IMPLIED WARRANTIES OF MERCHANTABILITY OR FITNESS FOR A PARTICULAR PURPOSE.

© 2025 CARFAX, Inc., part of S&P Global. All rights reserved.
5/24/25 3:15:03 AM (CDT)

I have reviewed and received a copy of the CARFAX Vehicle History Report for this 2023 AUDI Q5 vehicle (VIN: WA1ABAFY0P2193566), which is based on information supplied to CARFAX and available as of 5/24/25 at 4:15 AM (EDT).

Customer Signature

Date

Dealer Signature

Date

