

CARFAX History-Based Value Report

[Hide](#)

\$14,600

CARFAX Retail Value

Retail
 Wholesale

History events affecting this vehicle's value

- Service History
- Personal Vehicle
- Salvage Brand

CARFAX Vehicle History Report™

US \$44.99

2020 AUDI Q5 PREMIUM/TITANIUM PREMI

VIN: WA1ANAFY9L2051282
 4 DOOR WAGON/SPORT UTILITY
 2.0L I4
 GASOLINE
 ALL WHEEL DRIVE

Branded Title: Salvage >

11 Service history records >

2 Previous owners >

Types of owners: Personal lease, Personal >

Last owned in North Carolina >

69,305 Last reported odometer reading >

CARFAX HAS THE MOST ACCIDENT & DAMAGE INFORMATION



This CARFAX Vehicle History Report is based only on [information](#) supplied to CARFAX and available as of 10/30/25 at 5:33:52 AM (CDT). Other information about this vehicle, including problems, may not have been reported to CARFAX. Use this report as one important tool, along with a vehicle inspection and test drive, to make a better decision about your next used car.

CARFAX Accident / Damage History

Not all accidents / issues are reported to CARFAX

Event 1

09/13/2022

Accident reported: minor damage with another motor vehicle ⓘ

[View More Details >](#)

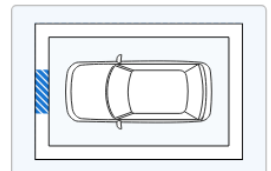
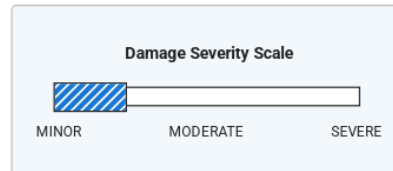

Event 2

09/18/2022

Accident reported: minor damage ⓘ

[View More Details >](#)

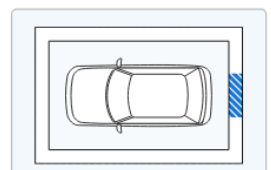
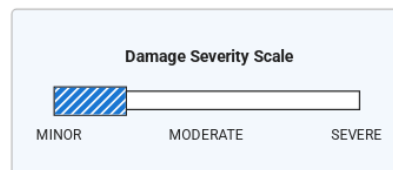

Event 3

08/16/2025

Accident reported: moderate damage ⓘ

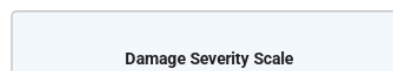

08/16/2025

Accident reported: moderate damage ⓘ

- Vehicle involved in a rear-end collision
- Vehicle towed
- Airbags did not deploy

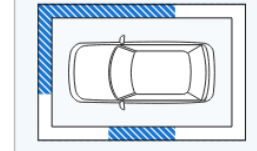
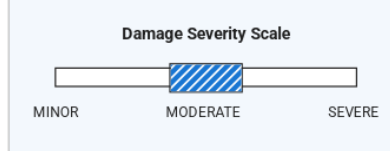
[View More Details >](#)[Show More ▾](#)**CARFAX** Recent Service Highlights

Key services performed in the last 12 months

Service & Comments	Service	Comments	View Details Links
Oil	✓ Oil and filter changed	08/11/2025	View Details >
 <div style="border: 1px solid #ccc; padding: 5px; display: inline-block;">This car has been recently serviced. That's a good thing!</div>			

CARFAX Additional History

Not all accidents / issues are reported to CARFAX

	Owner 1	Owner 2
Total Loss ⓘ Total Loss Reported: 10/13/2025.	✓ No Issues Reported	Total Loss Reported
Structural Damage ⓘ CARFAX recommends that you have this vehicle inspected by a collision repair specialist.	✓ No Issues Reported	✓ No Issues Reported
Airbag Deployment ⓘ No airbag deployment reported to CARFAX.	✓ No Issues Reported	✓ No Issues Reported
Odometer Check ⓘ No indication of an odometer rollback.	✓ No Issues Indicated	✓ No Issues Indicated
Accident / Damage ⓘ DMV title problems reported. Accidents reported: 09/13/2022, 09/18/2022, and 08/16/2025.	Accident Reported	Severe Damage
Manufacturer Recall ⓘ No open recalls reported to CARFAX.	✓ No Recalls Reported	✓ No Recalls Reported
Basic Warranty ⓘ Original manufacturer warranty likely voided by manufacturer.	✓ Warranty Active	Warranty Voided

CARFAX Title History

	Owner 1	Owner 2
Damage Brands ⓘ Salvage Junk Rebuilt Fire Flood Hail Lemon	No Problem	Alert! Problem Found
Odometer Brands ⓘ Not Actual Mileage Exceeds Mechanical Limits	No Problem	No Problem



ALERT! - Severe problems were reported by a state Department of Motor Vehicles (DMV). This vehicle does not qualify for the CARFAX Buyback Guarantee.

CARFAX Ownership History

The number of owners is estimated

	Owner 1	Owner 2

CARFAX Ownership History



The number of owners is estimated

	Owner 1	Owner 2
Year purchased	2020	2023
Type of owner	Personal lease	Personal
Estimated length of ownership	3 yrs. 3 mo.	1 yr. 11 mo.
Owned in the following states/provinces	New Jersey	Virginia, North Carolina
Estimated miles driven per year	11,423/yr	16,011/yr
Last reported odometer reading	37,560	69,305

CARFAX Detailed History

[Glossary](#)

Owner 1 Personal Lease Vehicle
 Purchased: 2020 11,423 mi/yr

Date	Mileage	Source	Comments
01/31/2020		NICB	Vehicle manufactured and shipped to original dealer
01/31/2020	66	Ciocca Porsche Audi Volkswagen of Flemington Flemington, NJ 908-782-2400 flemingtonporsche.com/ ★ 4.7 / 5.0 648 Verified Reviews ✓ ♥ 922 Customer Favorites	Vehicle sold
01/31/2020		Ciocca Porsche Audi Volkswagen of Flemington Flemington, NJ 908-782-2400 flemingtonporsche.com/ ★ 4.7 / 5.0 648 Verified Reviews ✓ ♥ 922 Customer Favorites	 Vehicle serviced - Pre-delivery inspection completed
02/12/2020		New Jersey Motor Vehicle Dept. Marlboro, NJ Title #GD20200431706	Title issued or updated - Registration issued or renewed - First owner reported - Titled or registered as personal lease vehicle - Vehicle color noted as Beige
05/19/2020		New Jersey Motor Vehicle Dept. Livingston, NJ	Registration issued or renewed - Registration updated when owner moved the vehicle to a new location - Vehicle color noted as Beige
03/22/2021	10,351	Paul Miller Audi Parsippany, NJ 973-575-7750 paulmilleraudi.com ★ 4.8 / 5.0 1,194 Verified Reviews ✓ ♥ 10,527 Customer Favorites	 Vehicle serviced - Engine/powertrain computer/module reprogrammed - Oil and filter changed - Tail light bulb(s) replaced - Vehicle washed/detailed
07/06/2021	15,110	Paul Miller Audi Parsippany, NJ 973-575-7750 paulmilleraudi.com ★ 4.8 / 5.0 1,194 Verified Reviews ✓ ♥ 10,527 Customer Favorites	 Vehicle serviced - Engine/powertrain computer/module reprogrammed - Vehicle washed/detailed

03/22/2022 24,478

Livingston Tire Company
Livingston, NJ
973-533-0101
livingstontire.com/

★ 4.9 / 5.0 [428 Verified Reviews](#) ✓

♥ 323 Customer Favorites



Vehicle serviced

- Tire condition and pressure checked
- Tire(s) balanced
- Tire(s) mounted
- Tire(s) replaced

04/15/2022 25,351

Paul Miller Audi
Parsippany, NJ
973-575-7750
paulmilleraudi.com

★ 4.8 / 5.0 [1,194 Verified Reviews](#) ✓

♥ 10,527 Customer Favorites



Vehicle serviced

- Alignment performed
- Tire condition and pressure checked
- Two wheel alignment performed
- Vehicle washed/detailed

09/13/2022

Damage Report



Accident reported: minor damage with another motor vehicle ⓘ

- Damage to front

CARFAX HAS THE MOST ACCIDENT & DAMAGE INFORMATION

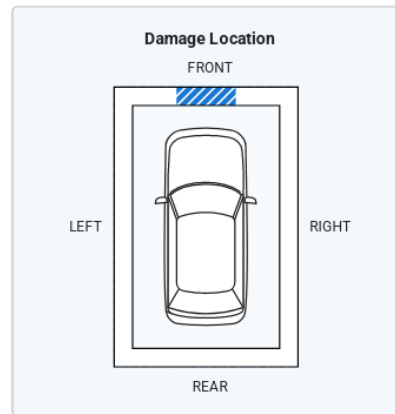
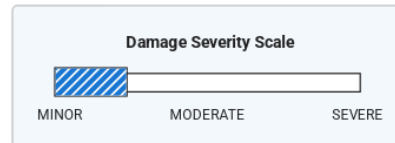

09/18/2022

Damage Report



Accident reported: minor damage ⓘ

- Damage to rear

CARFAX HAS THE MOST ACCIDENT & DAMAGE INFORMATION

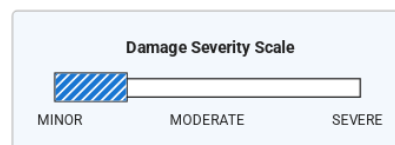

12/15/2022

New Jersey
Motor Vehicle Dept.
Livingston, NJ

Registration issued or renewed

- Vehicle color noted as Beige

05/24/2023

37,463

Volkswagen World of Newton
Newton, NJ
973-756-3100
newtonvolkswagen.com/

Vehicle offered for sale

newtonvolkswagen.com/

★ 4.4 / 5.0 [51 Verified Reviews](#) ✓

♥ 4 Customer Favorites

07/10/2023

37,516

Westgate Chrysler Jeep Dodge Ram
Raleigh, NC
919-865-5000
westgatejeep.com



Vehicle serviced

- Pre-delivery inspection completed
- Brakes checked
- Emissions inspection performed
- Oil and filter changed
- Safety inspection performed

★ 3.9 / 5.0 [1,289 Verified Reviews](#) ✓

♥ 18,135 Customer Favorites

09/07/2023

New Jersey
Motor Vehicle Dept.
Newton, NJ
Title #DA20232501010

Dealer took registration of this vehicle

- Title issued or updated
- Dealer took title of this vehicle while it was in inventory
- Vehicle color noted as Beige

09/22/2023

Westgate Chrysler Jeep Dodge Ram
Raleigh, NC
919-865-5000
westgatechryslerjeepdodge.com/

Vehicle offered for sale

★ 3.9 / 5.0 [1,289 Verified Reviews](#) ✓

♥ 18,135 Customer Favorites

10/23/2023

Virginia
Motor Vehicle Dept.

Vehicle purchase reported

10/30/2023

37,560

Westgate Imports
Raleigh, NC
919-782-7871
westgateimports.net



Vehicle serviced

- Paint protection applied

★ 4.5 / 5.0 [136 Verified Reviews](#) ✓

♥ 2 Customer Favorites

Owner 2

Purchased: 2023

Personal Vehicle

16,011 mi/yr

Date	Mileage	Source	Comments
11/06/2023		Virginia Motor Vehicle Dept. Charlottesville, VA	Title issued or updated - Title or registration issued - New owner reported - Loan or lien reported
11/07/2023	38,335	Westgate Imports Raleigh, NC 919-782-7871 westgateimports.net ★ 4.5 / 5.0 136 Verified Reviews ✓ ♥ 2 Customer Favorites	Vehicle serviced - Brakes checked - Tire condition and pressure checked
12/03/2024		Virginia Motor Vehicle Dept. Charlottesville, VA	Registration issued or renewed - Loan or lien reported
01/08/2025	58,520	Westgate Imports Raleigh, NC 919-782-7871 westgateimports.net ★ 4.5 / 5.0 136 Verified Reviews ✓ ♥ 2 Customer Favorites	Vehicle serviced - Fluids checked - Emissions or safety inspection performed - Oil and filter changed - Tire condition and pressure checked
05/09/2025	63,751	Westgate Imports Raleigh, NC 919-782-7871 westgateimports.net ★ 4.5 / 5.0 136 Verified Reviews ✓	Vehicle serviced - Maintenance inspection completed - Engine/powertrain computer/module checked

★ 4.5 / 5.0 [136 Verified Reviews](#) ✓
♥ 2 Customer Favorites

08/11/2025

68,885

Take 5 Oil Change
Raleigh, NC
919-782-2657
take5.com/



Vehicle serviced
- Oil and filter changed

★ 4.6 / 5.0 [207 Verified Reviews](#) ✓
♥ 126 Customer Favorites

08/16/2025

Damage Report



Accident reported: moderate damage ⓘ
- Vehicle involved in a rear-end collision
- Damage to right front
- Damage to front
- Damage to right side
- Damage to left side
- Vehicle towed
- Airbags did not deploy

**CARFAX HAS THE MOST
ACCIDENT & DAMAGE
INFORMATION**

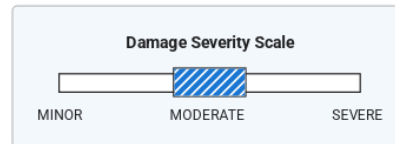

10/13/2025

North Carolina
Motor Vehicle Dept.

Title or registration issued to insurance company

10/13/2025

69,305

North Carolina
Motor Vehicle Dept.
Clayton, NC
Title #40960425286781A



TOTAL LOSS VEHICLE
- **SALVAGE TITLE/CERTIFICATE ISSUED**



There are many reasons an insurance company will declare a vehicle a total loss. Have this vehicle inspected by a qualified technician before you buy. [Learn More](#)

10/30/2025

Audi

Connect Service available with subscription

Connect offers services to enhance navigation, infotainment, and peace of mind

[Learn more](#)

Have Questions? Consumers, please visit our Help Center at www.carfax.com. Dealers or Subscribers, please visit our Help Center at www.carfaxonline.com.

Accident Indicator

CARFAX receives information about accidents in all 50 states, the District of Columbia and Canada.

Not every accident is reported to CARFAX. As details about the accident become available, those additional details are added to the CARFAX Vehicle History Report. CARFAX recommends that you have this vehicle inspected by a qualified mechanic.

CARFAX recommends that you have this vehicle inspected by a qualified mechanic.

- According to the National Safety Council, Injury Facts, 2021 edition, 5% of the 276 million registered vehicles in the U.S. were involved in an accident in 2019. Over 77% of these were considered minor or moderate.
- This CARFAX Vehicle History Report is based only on information supplied to CARFAX and available as of 10/30/25 at 5:33:52 AM (CDT). Other information about this vehicle, including problems, may not have been reported to CARFAX. Use this report as one important tool, along with a vehicle inspection and test drive, to make a better decision about your next used car.

Damage Indicator

Damage can be a result of many different types of events. Examples include contact with objects (other cars, trees, traffic signs, road debris, etc), vandalism, or weather-related events. Not every damage event is reported to CARFAX. As details about the damage event become available, those additional details are added to the CARFAX Vehicle History Report. CARFAX recommends that you have this vehicle inspected by a qualified mechanic.

- This CARFAX Vehicle History Report is based only on information supplied to CARFAX and available as of 10/30/25 at 5:33:52 AM (CDT). Other information about this vehicle, including problems, may not have been reported to CARFAX. Use this report as one important tool, along with a vehicle inspection and test drive, to make a better decision about your next used car.

Damage Severity

Damage events result in one of the following severity levels:

- Minor: Generally, minor damage is cosmetic (including dents or scratches), may only require reconditioning, and typically does not compromise a vehicle's operation and/or safety.
- Moderate: Moderate damage may affect multiple components of the vehicle and may impair the vehicle's operation and/or safety.
- Severe: Severe damage usually affects multiple components of the vehicle and is likely to compromise the vehicle's operation and/or safety.

CARFAX recommends getting a pre-purchase inspection at a certified collision repair facility.

First Owner

When the first owner(s) obtains a title from a Department of Motor Vehicles as proof of ownership.

New Owner Reported

When a vehicle is sold to a new owner, the Title must be transferred to the new owner(s) at a Department of Motor Vehicles.

Ownership History

CARFAX defines an owner as an individual or business that possesses and uses a vehicle. Not all title transactions represent changes in ownership. To provide estimated number of owners, CARFAX proprietary technology analyzes all the events in a vehicle history. Estimated ownership is available for vehicles manufactured after 1991 and titled solely in the US including Puerto Rico. Dealers sometimes opt to take ownership of a vehicle and are required to in the following states: Maine, Massachusetts, New Jersey, Ohio, Oklahoma, Pennsylvania and South Dakota. Please consider this as you review a vehicle's estimated ownership history.

Salvage Title



A Salvage Title is issued on a vehicle damaged to the extent that the cost of repairing the vehicle exceeds approximately 75% of its pre-damage value. This damage threshold may vary by state. Some states treat Junk titles the same as Salvage but the majority use this title to indicate that a vehicle is not road worthy and cannot be titled again in that state. The following eleven states also use Salvage titles to identify stolen vehicles - AZ, FL, GA, IL, MD, MN, NJ, NM, NY, OK and OR.

Title Issued

A state issues a title to provide a vehicle owner with proof of ownership. Each title has a unique number. Each title or registration record on a CARFAX report does not necessarily indicate a change in ownership. In Canada, a registration and bill of sale are used as proof of ownership.

Total Loss Vehicle

An insurance or fleet company declares a vehicle a total loss when a claim exceeds approximately 75% of its pre-damage value or if the vehicle is stolen and not recovered. This damage threshold varies by company. These companies typically take possession and obtain the title. Not all total loss vehicles result in a DMV-reported branded title. This may occur when an insurance company's definition of a total loss is different than the state DMV's definition for a branded title or when the owner of the vehicle is a self-insured company, like a fleet or rental company.

Follow Us:  facebook.com/CARFAX  [@CARFAXinc](https://twitter.com/CARFAXinc)  [About CARFAX](#)

CARFAX DEPENDS ON ITS SOURCES FOR THE ACCURACY AND RELIABILITY OF ITS INFORMATION. THEREFORE, NO RESPONSIBILITY IS ASSUMED BY CARFAX OR ITS AGENTS FOR ERRORS OR OMISSIONS IN THIS REPORT. CARFAX FURTHER EXPRESSLY DISCLAIMS ALL WARRANTIES, EXPRESS OR IMPLIED, INCLUDING ANY IMPLIED WARRANTIES OF MERCHANTABILITY OR FITNESS FOR A PARTICULAR PURPOSE.

© 2025 CARFAX, Inc., part of S&P Global. All rights reserved.
10/30/25 5:33:52 AM (CDT)

I have reviewed and received a copy of the CARFAX Vehicle History Report for this 2020 AUDI Q5 vehicle (VIN: WA1ANAFY9L2051282), which is based on information supplied to CARFAX and available as of 10/30/25 at 6:33 AM (EDT).

Customer Signature

Date

Dealer Signature

Date

