

CARFAX History-Based Value Report

[Hide](#)

\$60,570

CARFAX Retail Value

Retail
 Wholesale

History events affecting this vehicle's value

- 1-Owner Vehicle
- Regular Oil Changes
- Salvage Brand
- Open Recall

CARFAX Vehicle History Report™

US \$44.99

2023 AUDI SQ8 4.0T QUATTRO PREMIUM PLUS

VIN: WA1AWBF11PD027736
 4 DOOR WAGON/SPORT UTILITY
 4.0L V8
 GASOLINE
 ALL WHEEL DRIVE

Branded Title: Salvage >

Regular oil changes >

At least 1 open recall >

CARFAX 1-Owner vehicle >

Personal vehicle >

18,076 Last reported odometer reading >

CARFAX HAS THE MOST ACCIDENT & DAMAGE INFORMATION



This CARFAX Vehicle History Report is based only on [information](#) supplied to CARFAX and available as of 1/5/26 at 11:22:23 AM (CST). Other information about this vehicle, including problems, may not have been reported to CARFAX. Use this report as one important tool, along with a vehicle inspection and test drive, to make a better decision about your next used car.

CARFAX Accident / Damage History

Not all accidents / issues are reported to CARFAX

Event 1

08/29/2024

Damage reported: minor damage

[View More Details >](#)

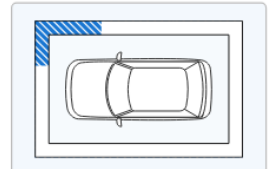
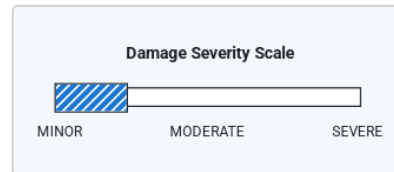

Event 2

12/01/2025

TOTAL LOSS VEHICLE

- Accident reported
- Vehicle declared a total loss by an insurance company

[View More Details >](#)

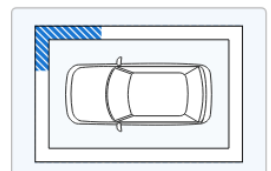

Event 3

12/08/2025

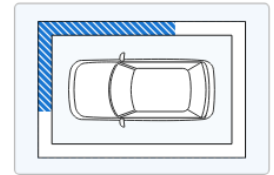
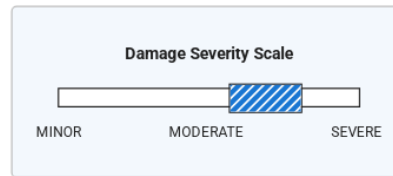
Damage reported: moderate to severe damage ⓘ[View More Details >](#)**CARFAX** Recent Service Highlights

Key services performed in the last 12 months

Service & Comments	Service	Comments	View Details Links
Tires	✓ Four wheel alignment performed	05/16/2025	View Details >
Brakes	✓ Brake fluid flushed/changed	04/25/2025	View Details >



This car has been recently serviced. That's a good thing!

CARFAX Additional History

Not all accidents / issues are reported to CARFAX

Owner 1

Total Loss ⓘ

Total Loss Reported: 12/01/2025.

[Total Loss Reported](#)**Structural Damage** ⓘ

CARFAX recommends that you have this vehicle inspected by a collision repair specialist.

✓ No Issues Reported

Airbag Deployment ⓘ

No airbag deployment reported to CARFAX.

✓ No Issues Reported

Odometer Check ⓘ

No indication of an odometer rollback.

✓ No Issues Indicated

Accident / Damage ⓘ

DMV title problems reported. Damage reported: 08/29/2024 and 12/08/2025. Accident reported: 12/01/2025.

[Severe Damage](#)**Manufacturer Recall** ⓘAt least 1 manufacturer recall requires service. Locate an authorized [Audi dealer](#) to obtain more information about this recall.[Recall Reported](#)**Basic Warranty** ⓘ

Original manufacturer warranty likely voided by manufacturer.

Warranty Voided**CARFAX** Title History

Owner 1

Damage Brands ⓘ

Salvage | Junk | Rebuilt | Fire | Flood | Hail | Lemon

Alert!
Problem Found**Odometer Brands** ⓘ

Not Actual Mileage | Exceeds Mechanical Limits

No Problem

**ALERT!** - Severe problems were reported by a state Department of Motor Vehicles (DMV). This vehicle does not qualify for the CARFAX Buyback Guarantee.**CARFAX** Ownership History

CARFAX Ownership History

The number of owners is estimated

Owner 1

Year purchased	2023
Type of owner	Personal
Estimated length of ownership	2 yrs. 6 mo.
Owned in the following states/provinces	Ohio
Estimated miles driven per year	7,330/yr
Last reported odometer reading	18,076





CARFAX Detailed History[Glossary](#)

Owner 1

Purchased: 2023

Personal Vehicle

7,330 mi/yr

Date	Mileage	Source	Comments
Not Reported		NICB	Vehicle manufactured and shipped to original dealer
05/18/2023	8	Audi of Bedford Bedford, OH 440-232-4700 audiofbedford.com ★ 4.6 / 5.0 539 Verified Reviews ✓ ♥ 6,312 Customer Favorites	 Vehicle serviced - Pre-delivery inspection completed
06/23/2023		ECP Certified Installer 800-323-3521 ecpinc.net ★ 4.4 / 5.0 154 Verified Reviews ✓ ♥ 3 Customer Favorites	 Vehicle serviced - Paint protection applied
06/23/2023		Ohio Motor Vehicle Dept.	Vehicle purchase reported - Titled or registered as personal vehicle
06/26/2023	15	Audi of Bedford Bedford, OH 440-232-4700 audiofbedford.com ★ 4.6 / 5.0 539 Verified Reviews ✓ ♥ 6,312 Customer Favorites	 Vehicle serviced - Vehicle washed/detailed
07/06/2023	125	Ohio Motor Vehicle Dept. Willoughby, OH Title #4304703851	Title issued or updated - Registration issued or renewed - First owner reported - Loan or lien reported
07/14/2023	661	Honda of Mentor Mentor, OH 440-974-9500 hondaofmentor.com ★ 4.8 / 5.0 1,462 Verified Reviews ✓ ♥ 12,865 Customer Favorites	 Vehicle serviced
10/30/2023		Ohio Motor Vehicle Dept. Willoughby, OH Title #4304703851	Registration issued or renewed

Motor Vehicle Dept.
Willoughby, OH
Title #4304703851

05/24/2024 7,672

Audi Mentor
Mentor, OH
440-209-4000
audimentor.com

★ 4.8 / 5.0 [526 Verified Reviews](#) ✓
♥ 4,850 Customer Favorites



Vehicle serviced
- Maintenance inspection completed
- 10,000 mile service performed
- Tire(s) balanced
- Tire(s) mounted

08/29/2024

Damage Report



Damage reported: minor damage ⓘ
- Damage to right front

**CARFAX HAS THE MOST
ACCIDENT & DAMAGE
INFORMATION**

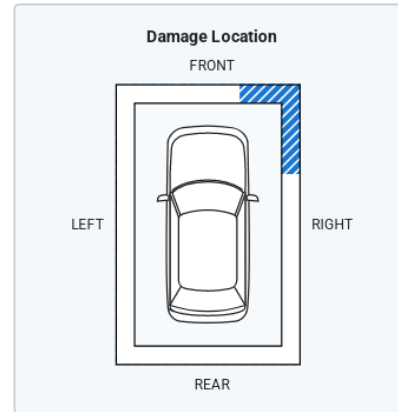
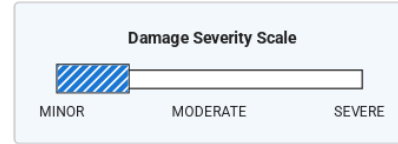

09/10/2024 10,197

Honda of Mentor
Mentor, OH
440-974-9500
hondaofmentor.com

★ 4.8 / 5.0 [1,462 Verified Reviews](#) ✓
♥ 12,865 Customer Favorites



Vehicle serviced

09/23/2024 10,198

Audi Mentor
Mentor, OH
440-209-4000
audimentor.com

★ 4.8 / 5.0 [526 Verified Reviews](#) ✓
♥ 4,850 Customer Favorites



Vehicle serviced
- Wiper(s) replaced

10/24/2024

Ohio
Motor Vehicle Dept.
Willoughby, OH
Title #4304703851

Registration issued or renewed

12/17/2024 14,022

Audi Mentor
Mentor, OH
440-209-4000
audimentor.com

★ 4.8 / 5.0 [526 Verified Reviews](#) ✓
♥ 4,850 Customer Favorites



Vehicle serviced
- Maintenance inspection completed
- Electrical system checked
- Interior trim checked
- Trim checked

01/31/2025 15,372

Audi Mentor
Mentor, OH
440-209-4000
audimentor.com

★ 4.8 / 5.0 [526 Verified Reviews](#) ✓
♥ 4,850 Customer Favorites



Vehicle serviced
- Maintenance inspection completed
- Electrical system checked
- Engine/powertrain computer/module checked
- Tire condition and pressure checked

02/22/2025 15,634

Audi of Bedford
Bedford, OH
440-232-4700
audiofbedford.com



Vehicle serviced
- Maintenance inspection completed
- Drivability/performance checked

Bedford, OH
440-232-4700
audiofbedford.com

★ 4.6 / 5.0 [539 Verified Reviews](#) ✓
♥ 6,312 Customer Favorites

- Maintenance inspection completed
- Drivability/performance checked

04/25/2025 17,299

Audi Mentor
Mentor, OH
440-209-4000
audimentor.com



Vehicle serviced

- Maintenance inspection completed
- 20,000 mile service performed
- Brake fluid flushed/changed

★ 4.8 / 5.0 [526 Verified Reviews](#) ✓
♥ 4,850 Customer Favorites

05/16/2025 18,075

Audi Mentor
Mentor, OH
440-209-4000
audimentor.com



Vehicle serviced

- Maintenance inspection completed
- Body electrical system checked
- Four wheel alignment performed

★ 4.8 / 5.0 [526 Verified Reviews](#) ✓
♥ 4,850 Customer Favorites

05/17/2025

Honda of Mentor
Mentor, OH
440-974-9500
hondaofmentor.com



Vehicle serviced

★ 4.8 / 5.0 [1,462 Verified Reviews](#) ✓
♥ 12,865 Customer Favorites

11/26/2025

Ohio
Motor Vehicle Dept.
Willoughby, OH
Title #4304703851

Registration issued or renewed

12/01/2025

Damage Report



TOTAL LOSS VEHICLE

- Accident reported
- Vehicle declared a total loss by an insurance company
- Damage to right front

CARFAX HAS THE MOST ACCIDENT & DAMAGE INFORMATION

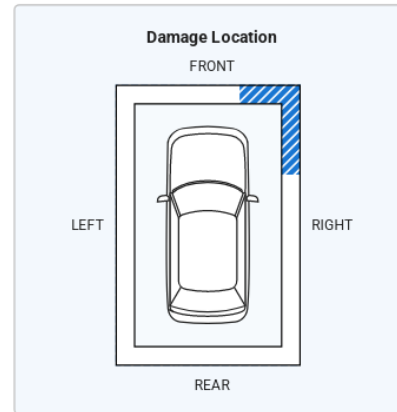

There are many reasons an insurance company will declare a vehicle a total loss. Have this vehicle inspected by a qualified technician before you buy. [Learn More](#)

12/08/2025

Damage Report



Damage reported: moderate to severe damage ⓘ

- Damage to front
- Damage to right side
- Damage to right front

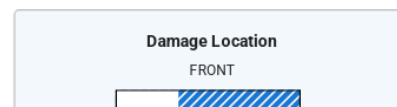
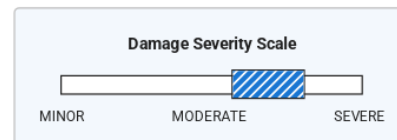



CARFAX HAS THE MOST

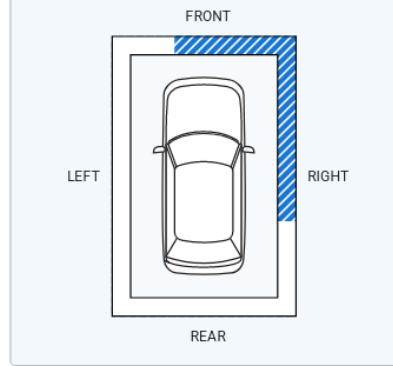

CARFAX HAS THE MOST ACCIDENT & DAMAGE INFORMATION



12/09/2025	18,076	Audi Mentor Mentor, OH 440-209-4000 audimmentor.com ★ 4.8 / 5.0 526 Verified Reviews ✓ ♥ 4,850 Customer Favorites		Vehicle serviced - Body electrical system checked
12/15/2025		Honda of Mentor Mentor, OH 440-974-9500 hondaofmentor.com ★ 4.8 / 5.0 1,462 Verified Reviews ✓ ♥ 12,865 Customer Favorites		Vehicle serviced
12/23/2025		Audi		Manufacturer Compliance Recall issued - NHTSA #25V900 - Recall #90TV REARVIEW CAMERA SOFTWARE - Status: Remedy Available Locate an authorized Audi dealer to obtain more information about this recall + Learn more about this recall
12/30/2025		Damage Report		SALVAGE TITLE/CERTIFICATE ISSUED
01/05/2026		Audi		Connect Service available with subscription Connect offers services to enhance navigation, infotainment, and peace of mind Learn more



This vehicle's oil change history, as reported to CARFAX, follows the manufacturer's recommendation. Track your service history for free at [carfax.com/service](https://www.carfax.com/service).

Have Questions? Consumers, please visit our Help Center at www.carfax.com. Dealers or Subscribers, please visit our Help Center at www.carfaxonline.com.

CARFAX Glossary

[Full Glossary](#)

Accident Indicator

CARFAX receives information about accidents in all 50 states, the District of Columbia and Canada.

Not every accident is reported to CARFAX. As details about the accident become available, those additional details are added to the CARFAX Vehicle History Report. CARFAX recommends that you have this vehicle inspected by a qualified mechanic.

- According to the National Safety Council, Injury Facts, 2021 edition, 5% of the 276 million registered vehicles in the U.S. were involved in an accident in 2019. Over 77% of these were considered minor or moderate.
- This CARFAX Vehicle History Report is based only on information supplied to CARFAX and available as of 1/5/26 at 11:22:23 AM (CST). Other information about this vehicle, including problems, may not have been reported to CARFAX. Use this report as one important tool, along with a vehicle inspection and test drive, to make a better decision about your next used car.

CARFAX Well Maintained - Regular Oil Changes

CARFAX identifies a "Well Maintained - Regular Oil Change" vehicle as having a regular oil change history when all its recommended oil changes, based on the vehicle's

CARFAX Well Maintained - Regular Oil Changes

CARFAX identifies a "Well Maintained - Regular Oil Change" vehicle as having a regular oil change history when all its recommended oil changes, based on the vehicle's maintenance schedule, have been reported to CARFAX. CARFAX uses the manufacturer's schedule and assumes normal driving conditions. When an oil change schedule is not available, CARFAX may analyze reported service events to determine what is typical for the same make and model vehicle. Dealers and service shops may publish different recommended service schedules.

Damage Indicator

Damage can be a result of many different types of events. Examples include contact with objects (other cars, trees, traffic signs, road debris, etc), vandalism, or weather-related events. Not every damage event is reported to CARFAX. As details about the damage event become available, those additional details are added to the CARFAX Vehicle History Report. CARFAX recommends that you have this vehicle inspected by a qualified mechanic.

- This CARFAX Vehicle History Report is based only on information supplied to CARFAX and available as of 1/5/26 at 11:22:23 AM (CST). Other information about this vehicle, including problems, may not have been reported to CARFAX. Use this report as one important tool, along with a vehicle inspection and test drive, to make a better decision about your next used car.

Damage Severity

Damage events result in one of the following severity levels:

- Minor: Generally, minor damage is cosmetic (including dents or scratches), may only require reconditioning, and typically does not compromise a vehicle's operation and/or safety.
- Moderate: Moderate damage may affect multiple components of the vehicle and may impair the vehicle's operation and/or safety.
- Severe: Severe damage usually affects multiple components of the vehicle and is likely to compromise the vehicle's operation and/or safety.

CARFAX recommends getting a pre-purchase inspection at a certified collision repair facility.

First Owner

When the first owner(s) obtains a title from a Department of Motor Vehicles as proof of ownership.

Manufacturer Recall

Automobile manufacturers issue recall notices to inform vehicle owners of a safety defect or failure to meet minimum federal safety or emissions standards. Manufacturer recalls are repaired at no cost to the customer.

Ownership History

CARFAX defines an owner as an individual or business that possesses and uses a vehicle. Not all title transactions represent changes in ownership. To provide estimated number of owners, CARFAX proprietary technology analyzes all the events in a vehicle history. Estimated ownership is available for vehicles manufactured after 1991 and titled solely in the US including Puerto Rico. Dealers sometimes opt to take ownership of a vehicle and are required to in the following states: Maine, Massachusetts, New Jersey, Ohio, Oklahoma, Pennsylvania and South Dakota. Please consider this as you review a vehicle's estimated ownership history.

Salvage Title



A Salvage Title is issued on a vehicle damaged to the extent that the cost of repairing the vehicle exceeds approximately 75% of its pre-damage value. This damage threshold may vary by state. Some states treat Junk titles the same as Salvage but the majority use this title to indicate that a vehicle is not road worthy and cannot be titled again in that state. The following eleven states also use Salvage titles to identify stolen vehicles - AZ, FL, GA, IL, MD, MN, NJ, NM, NY, OK and OR.

Title Issued

A state issues a title to provide a vehicle owner with proof of ownership. Each title has a unique number. Each title or registration record on a CARFAX report does not necessarily indicate a change in ownership. In Canada, a registration and bill of sale are used as proof of ownership.

Total Loss Vehicle

An insurance or fleet company declares a vehicle a total loss when a claim exceeds approximately 75% of its pre-damage value or if the vehicle is stolen and not recovered. This damage threshold varies by company. These companies typically take possession and obtain the title. Not all total loss vehicles result in a DMV-reported branded title. This may occur when an insurance company's definition of a total loss is different than the state DMV's definition for a branded title or when the owner of the vehicle is a self-insured company, like a fleet or rental company.

Follow Us:  facebook.com/CARFAX  [@CARFAXinc](https://twitter.com/CARFAXinc)  [About CARFAX](#)

CARFAX DEPENDS ON ITS SOURCES FOR THE ACCURACY AND RELIABILITY OF ITS INFORMATION. THEREFORE, NO RESPONSIBILITY IS ASSUMED BY CARFAX OR ITS AGENTS FOR ERRORS OR OMISSIONS IN THIS REPORT. CARFAX FURTHER EXPRESSLY DISCLAIMS ALL WARRANTIES, EXPRESS OR IMPLIED, INCLUDING ANY IMPLIED WARRANTIES OF MERCHANTABILITY OR FITNESS FOR A PARTICULAR PURPOSE.

© 2026 CARFAX, Inc., part of S&P Global. All rights reserved.
1/5/26 11:22:23 AM (CST)

I have reviewed and received a copy of the CARFAX Vehicle History Report for this 2023 AUDI SQ8 vehicle (VIN: WA1AWBF11PD027736), which is based on information supplied to CARFAX and available as of 1/5/26 at 12:22 PM (EST).

Customer Signature

Date

Dealer Signature

Date

