

## CARFAX History-Based Value Report

[Hide](#)

# \$23,400

CARFAX Retail Value

Retail
  Wholesale

### History events affecting this vehicle's value

- Regular Oil Changes
- Personal Vehicle
- Dismantled Brand

## CARFAX Vehicle History Report™

US \$44.99

### 2020 AUDI Q5 QUATTRO PREMIUM PLUS 45 TFSI

VIN: WA1BNAFY6L2027137  
 4 DOOR WAGON/SPORT UTILITY  
 2.0L I4  
 GASOLINE  
 ALL WHEEL DRIVE

Branded Title: Dismantled >

Regular oil changes >

2 Previous owners >

Personal lease vehicle >

Last owned in New Hampshire >

25,987 Last reported odometer reading >

**CARFAX HAS THE MOST ACCIDENT & DAMAGE INFORMATION**



This CARFAX Vehicle History Report is based only on [information](#) supplied to CARFAX and available as of 8/25/25 at 5:57:48 PM (CDT). Other information about this vehicle, including problems, may not have been reported to CARFAX. Use this report as one important tool, along with a vehicle inspection and test drive, to make a better decision about your next used car.

## CARFAX Accident / Damage History

Not all accidents / issues are reported to CARFAX

### Event 1

08/12/2024

#### Accident reported: minor damage ⓘ

- Vehicle involved in a rear-end collision with another motor vehicle
- Disabling damage reported
- Vehicle towed
- Airbags did not deploy

[View More Details >](#)

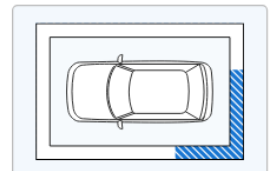
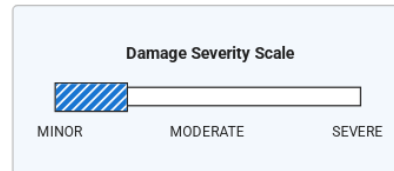

### Event 2

08/22/2025

#### Accident reported

- **DISMANTLED TITLE ISSUED**

[View More Details >](#)

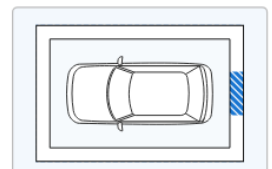







<b>CARFAX</b> Additional History Not all accidents / issues are reported to CARFAX	Owner 1	Owner 2
<b>Total Loss</b> ⓘ No total loss reported to CARFAX.	✔ No Issues Reported	✔ No Issues Reported
<b>Structural Damage</b> ⓘ CARFAX recommends that you have this vehicle inspected by a collision repair specialist.	✔ No Issues Reported	✔ No Issues Reported
<b>Airbag Deployment</b> ⓘ No airbag deployment reported to CARFAX.	✔ No Issues Reported	✔ No Issues Reported
<b>Odometer Check</b> ⓘ No indication of an odometer rollback.	✔ No Issues Indicated	✔ No Issues Indicated
<b>Accident / Damage</b> ⓘ Accidents reported: 08/12/2024 and 08/22/2025.	✔ No Issues Reported	<a href="#">Severe Damage</a>
<b>Manufacturer Recall</b> ⓘ No open recalls reported to CARFAX.	✔ No Recalls Reported	✔ No Recalls Reported
<b>Basic Warranty</b> ⓘ Original manufacturer warranty likely voided by manufacturer.	✔ Warranty Active	<b>Warranty Voided</b>







<b>CARFAX</b> Title History	Owner 1	Owner 2
<b>Damage Brands</b> ⓘ Salvage   Junk   Rebuilt   Fire   Flood   Hail   Lemon	No Problem	<b>Alert!</b> Problem Found
<b>Odometer Brands</b> ⓘ Not Actual Mileage   Exceeds Mechanical Limits	No Problem	No Problem
 <b>ALERT!</b> - Severe problems were reported by a state Department of Motor Vehicles (DMV). This vehicle does not qualify for the CARFAX Buyback Guarantee.		

<b>CARFAX</b> Ownership History The number of owners is estimated	Owner 1	Owner 2
Year purchased	2020	2023
Type of owner	Personal lease	Personal lease
Estimated length of ownership	3 years	2 years
Owned in the following states/provinces	Florida	Florida, New Hampshire
Estimated miles driven per year	6,981/yr	4,781/yr
Last reported odometer reading	21,080	25,987

**CARFAX** Detailed History [Glossary](#)

 <b>Owner 1</b> Purchased: 2020	Personal Lease Vehicle 6,981 mi/yr
Date	Mileage
Source	Comments

Date	Mileage	Source		Comments
Not Reported		NICB		Vehicle manufactured and shipped to original dealer
12/17/2019		Audi Volkswagen of Naples Naples, FL 239-302-3287 vwofnaples.com  ★ 4.7 / 5.0 <a href="#">2,350 Verified Reviews</a> ✓ ♥ 20,386 Customer Favorites		Vehicle offered for sale
12/31/2019	2	Audi Volkswagen of Naples Naples, FL 239-302-3287 vwofnaples.com  ★ 4.7 / 5.0 <a href="#">2,350 Verified Reviews</a> ✓ ♥ 20,386 Customer Favorites		Vehicle serviced - Window tint installed
02/07/2020	18	Audi Volkswagen of Naples Naples, FL 239-302-3287 vwofnaples.com  ★ 4.7 / 5.0 <a href="#">2,350 Verified Reviews</a> ✓ ♥ 20,386 Customer Favorites		Vehicle serviced - Maintenance inspection completed
03/16/2020	29	Audi Volkswagen of Naples Naples, FL 239-302-3287 vwofnaples.com  ★ 4.7 / 5.0 <a href="#">2,350 Verified Reviews</a> ✓ ♥ 20,386 Customer Favorites		Vehicle serviced - Maintenance inspection completed
05/04/2020	48	Audi Volkswagen of Naples Naples, FL 239-302-3287 vwofnaples.com  ★ 4.7 / 5.0 <a href="#">2,350 Verified Reviews</a> ✓ ♥ 20,386 Customer Favorites		Vehicle serviced - Maintenance inspection completed
06/29/2020		Florida Motor Vehicle Dept. Naples, FL Title #0138978556		Vehicle purchase reported - Title issued or updated - Registration issued or renewed - First owner reported - Titled or registered as personal lease vehicle - Loan or lien reported - Vehicle color noted as Black
07/01/2020		Audi Volkswagen of Naples Naples, FL 239-302-3287 vwofnaples.com  ★ 4.7 / 5.0 <a href="#">2,350 Verified Reviews</a> ✓ ♥ 20,386 Customer Favorites		Vehicle sold
07/03/2020	53	Audi Volkswagen of Naples Naples, FL 239-302-3287 vwofnaples.com  ★ 4.7 / 5.0 <a href="#">2,350 Verified Reviews</a> ✓ ♥ 20,386 Customer Favorites		Vehicle serviced - Maintenance inspection completed
07/17/2020	56	Florida Motor Vehicle Dept. Naples, FL Title #0138978556		Title issued or updated - Registration issued or renewed - Vehicle color noted as Black
04/01/2021		Florida		Registration issued or renewed

04/01/2021		Florida Motor Vehicle Dept. Naples, FL Title #0138978556		<b>Registration issued or renewed</b> - Vehicle color noted as Black
06/29/2021	7,781	Audi Volkswagen of Naples Naples, FL 239-302-3287 vwofnaples.com ★ 4.7 / 5.0 <a href="#">2,350 Verified Reviews</a> ✓ ♥ 20,386 Customer Favorites		<b>Vehicle serviced</b> - Maintenance inspection completed - 10,000 mile service performed - Oil and filter changed - Tire condition and pressure checked - Tires rotated
04/21/2022	14,209	Audi Volkswagen of Naples Naples, FL 239-302-3287 vwofnaples.com ★ 4.7 / 5.0 <a href="#">2,350 Verified Reviews</a> ✓ ♥ 20,386 Customer Favorites		<b>Vehicle serviced</b> - Maintenance inspection completed - Electrical system checked - Glove box repaired/replaced - Tire condition and pressure checked
05/02/2022	14,379	Audi Volkswagen of Naples Naples, FL 239-302-3287 vwofnaples.com ★ 4.7 / 5.0 <a href="#">2,350 Verified Reviews</a> ✓ ♥ 20,386 Customer Favorites		<b>Vehicle serviced</b> - Maintenance inspection completed - Electrical system checked
05/25/2022	14,872	Audi Volkswagen of Naples Naples, FL 239-302-3287 vwofnaples.com ★ 4.7 / 5.0 <a href="#">2,350 Verified Reviews</a> ✓ ♥ 20,386 Customer Favorites		<b>Vehicle serviced</b> - Maintenance inspection completed - Noise checked
06/20/2022	15,383	Audi Volkswagen of Naples Naples, FL 239-302-3287 vwofnaples.com ★ 4.7 / 5.0 <a href="#">2,350 Verified Reviews</a> ✓ ♥ 20,386 Customer Favorites		<b>Vehicle serviced</b> - Recommended maintenance performed - 20,000 mile service performed - Brake fluid flushed/changed - Oil and filter changed - Tire condition and pressure checked
03/27/2023		Florida Motor Vehicle Dept. Naples, FL Title #0138978556		<b>Registration issued or renewed</b> - Vehicle color noted as Black
06/05/2023	20,795	Audi Volkswagen of Naples Naples, FL 239-302-3287 vwofnaples.com ★ 4.7 / 5.0 <a href="#">2,350 Verified Reviews</a> ✓ ♥ 20,386 Customer Favorites		<b>Vehicle serviced</b> - Maintenance inspection completed - Recommended maintenance performed - 30,000 mile service performed - Oil and filter changed - Tire condition and pressure checked - Tires rotated
07/06/2023	21,079	Audi Fort Myers Fort Myers, FL 888-500-1763 fortmyersaudi.com/index.htm ★ 4.8 / 5.0 <a href="#">1,210 Verified Reviews</a> ✓ ♥ 10,404 Customer Favorites		<b>Vehicle offered for sale</b>
07/06/2023	21,080	Audi Fort Myers Fort Myers, FL 888-500-1763 fortmyersaudi.com/index.htm ★ 4.8 / 5.0 <a href="#">1,210 Verified Reviews</a> ✓ ♥ 10,404 Customer Favorites		<b>Vehicle serviced</b> - Pre-delivery inspection completed - Alignment checked - Battery/charging system checked - Differential checked - Four tires balanced - Four tires replaced - Four wheel alignment performed - One tire balanced - Tire condition and pressure checked

- Four wheel alignment performed
- One tire balanced
- Tire condition and pressure checked
- Tire(s) replaced
- Vehicle washed/detailed



Looks like this dealer serviced the car in order to prepare it for sale. That's a good thing!

07/31/2023

PermaPlate Certified Installer  
801-974-5557  
permaplate.com/



**Vehicle serviced**

- Interior protective coating applied
- Paint protection applied

★ 3.7 / 5.0 [22 Verified Reviews](#) ✓

♥ 1 Customer Favorite

**Owner 2**

Purchased: 2023

Personal Lease Vehicle

4,781 mi/yr

Date	Mileage	Source	Comments
07/31/2023	21,088	New Hampshire Motor Vehicle Dept.	<b>Vehicle purchase reported</b>
08/01/2023		Florida Motor Vehicle Dept. Plaistow, NH Title #0138978556	<b>Registration issued or renewed</b> - Titled or registered as personal lease vehicle - Vehicle color noted as Black
10/10/2023		New Hampshire Motor Vehicle Dept. Plaistow, NH	<b>Registration issued or renewed</b> - Vehicle color noted as Black
10/26/2023		New Hampshire Motor Vehicle Dept. Plaistow, NH Title #16867982	<b>Title issued or updated</b> - New owner reported - Loan or lien reported - Vehicle color noted as Black
06/03/2024		New Hampshire Motor Vehicle Dept. Plaistow, NH	<b>Registration issued or renewed</b> - Vehicle color noted as Black
08/08/2024	25,987	Audi Fort Myers Fort Myers, FL 888-500-1763 fortmyersaudi.com/index.htm	<b>Vehicle serviced</b> - Anti-theft/keyless remote battery replaced - Anti-theft/keyless remote(s) replaced - Brake fluid flushed/changed - Oil and filter changed
08/12/2024		Damage Report	<b>Accident reported: minor damage</b> ⓘ - Vehicle involved in a rear-end collision with another motor vehicle - Damage to rear - Damage to left rear - Disabling damage reported - Vehicle towed - Airbags did not deploy



Two states? Vehicle leasing companies often title a car in one state but register it to be driven in another.



**Vehicle serviced**

- Anti-theft/keyless remote battery replaced
- Anti-theft/keyless remote(s) replaced
- Brake fluid flushed/changed
- Oil and filter changed

★ 4.8 / 5.0 [1,210 Verified Reviews](#) ✓

♥ 10,404 Customer Favorites



**Accident reported: minor damage** ⓘ

- Vehicle involved in a rear-end collision with another motor vehicle
- Damage to rear
- Damage to left rear
- Disabling damage reported
- Vehicle towed
- Airbags did not deploy

**Damage Severity Scale**



**Damage Location**

FRONT



## CARFAX HAS THE MOST ACCIDENT & DAMAGE INFORMATION

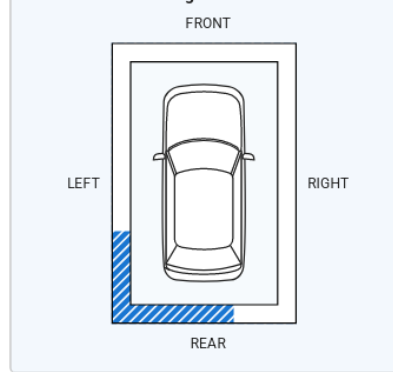

08/22/2025

Damage Report



### Accident reported

- Damage to rear
- **DISMANTLED TITLE ISSUED**

## CARFAX HAS THE MOST ACCIDENT & DAMAGE INFORMATION



08/25/2025

Audi

### Connect Service available with subscription

Connect offers services to enhance navigation, infotainment, and peace of mind

[Learn more](#)



This vehicle's oil change history, as reported to CARFAX, follows the manufacturer's recommendation. Track your service history for free at [carfax.com/service](https://www.carfax.com/service).

Have Questions? Consumers, please visit our Help Center at [www.carfax.com](https://www.carfax.com). Dealers or Subscribers, please visit our Help Center at [www.carfaxonline.com](https://www.carfaxonline.com).

### Accident Indicator

CARFAX receives information about accidents in all 50 states, the District of Columbia and Canada.

Not every accident is reported to CARFAX. As details about the accident become available, those additional details are added to the CARFAX Vehicle History Report. CARFAX recommends that you have this vehicle inspected by a qualified mechanic.

- According to the National Safety Council, Injury Facts, 2021 edition, 5% of the 276 million registered vehicles in the U.S. were involved in an accident in 2019. Over 77% of these were considered minor or moderate.
- This CARFAX Vehicle History Report is based only on information supplied to CARFAX and available as of 8/25/25 at 5:57:48 PM (CDT). Other information about this vehicle, including problems, may not have been reported to CARFAX. Use this report as one important tool, along with a vehicle inspection and test drive, to make a better decision about your next used car.

### CARFAX Well Maintained - Regular Oil Changes

CARFAX identifies a "Well Maintained - Regular Oil Change" vehicle as having a regular oil change history when all its recommended oil changes, based on the vehicle's maintenance schedule, have been reported to CARFAX. CARFAX uses the manufacturer's schedule and assumes normal driving conditions. When an oil change schedule is not available, CARFAX may analyze reported service events to determine what is typical for the same make and model vehicle. Dealers and service shops may publish different recommended service schedules.

### Damage Indicator

Damage can be a result of many different types of events. Examples include contact with objects (other cars, trees, traffic signs, road debris, etc), vandalism, or weather-related events. Not every damage event is reported to CARFAX. As details about the damage event become available, those additional details are added to the CARFAX Vehicle History Report. CARFAX recommends that you have this vehicle inspected by a qualified mechanic.

related events. Not every damage event is reported to CARFAX. As details about the damage event become available, those additional details are added to the CARFAX Vehicle History Report. CARFAX recommends that you have this vehicle inspected by a qualified mechanic.

- This CARFAX Vehicle History Report is based only on information supplied to CARFAX and available as of 8/25/25 at 5:57:48 PM (CDT). Other information about this vehicle, including problems, may not have been reported to CARFAX. Use this report as one important tool, along with a vehicle inspection and test drive, to make a better decision about your next used car.

#### Damage Severity

Damage events result in one of the following severity levels:

- Minor: Generally, minor damage is cosmetic (including dents or scratches), may only require reconditioning, and typically does not compromise a vehicle's operation and/or safety.
- Moderate: Moderate damage may affect multiple components of the vehicle and may impair the vehicle's operation and/or safety.
- Severe: Severe damage usually affects multiple components of the vehicle and is likely to compromise the vehicle's operation and/or safety.

CARFAX recommends getting a pre-purchase inspection at a certified collision repair facility.

#### Dismantled Title

The vehicle sustained major damage to one or more major component parts and the cost of repairing the vehicle for safe operation exceeds its fair market value. When a Dismantled title is issued, the vehicle may be used only for parts or scrap metal. It cannot be re-titled or returned to the road.

#### First Owner

When the first owner(s) obtains a title from a Department of Motor Vehicles as proof of ownership.

#### New Owner Reported



When a vehicle is sold to a new owner, the Title must be transferred to the new owner(s) at a Department of Motor Vehicles.

#### Ownership History

CARFAX defines an owner as an individual or business that possesses and uses a vehicle. Not all title transactions represent changes in ownership. To provide estimated number of owners, CARFAX proprietary technology analyzes all the events in a vehicle history. Estimated ownership is available for vehicles manufactured after 1991 and titled solely in the US including Puerto Rico. Dealers sometimes opt to take ownership of a vehicle and are required to in the following states: Maine, Massachusetts, New Jersey, Ohio, Oklahoma, Pennsylvania and South Dakota. Please consider this as you review a vehicle's estimated ownership history.

#### Title Issued

A state issues a title to provide a vehicle owner with proof of ownership. Each title has a unique number. Each title or registration record on a CARFAX report does not necessarily indicate a change in ownership. In Canada, a registration and bill of sale are used as proof of ownership.

Follow Us:  [facebook.com/CARFAX](https://facebook.com/CARFAX)  [@CARFAXinc](https://twitter.com/CARFAXinc)  [About CARFAX](#)

CARFAX DEPENDS ON ITS SOURCES FOR THE ACCURACY AND RELIABILITY OF ITS INFORMATION. THEREFORE, NO RESPONSIBILITY IS ASSUMED BY CARFAX OR ITS AGENTS FOR ERRORS OR OMISSIONS IN THIS REPORT. CARFAX FURTHER EXPRESSLY DISCLAIMS ALL WARRANTIES, EXPRESS OR IMPLIED, INCLUDING ANY IMPLIED WARRANTIES OF MERCHANTABILITY OR FITNESS FOR A PARTICULAR PURPOSE.

© 2025 CARFAX, Inc., part of S&P Global. All rights reserved.  
8/25/25 5:57:48 PM (CDT)

**I have reviewed and received a copy of the CARFAX Vehicle History Report for this 2020 AUDI Q5 vehicle (VIN: WA1BNAFY6L2027137), which is based on information supplied to CARFAX and available as of 8/25/25 at 6:57 PM (EDT).**

Customer Signature

Date

Dealer Signature

Date