

# CARFAX Vehicle History Report™

US \$44.99

## 2018 AUDI SQ5 3.0T QUATTRO PRESTIGE

VIN: WA1C4AFY6J2211529  
 4 DOOR WAGON/SPORT UTILITY  
 3.0L V6 F DOHC 24V  
 GASOLINE  
 ALL WHEEL DRIVE

Branded Title: Salvage >

23 Service history records >

2 Previous owners >

Types of owners: Personal lease, Personal >

Last owned in Georgia >

68,033 Last reported odometer reading >

This CARFAX Vehicle History Report is based only on [information](#) supplied to CARFAX and available as of 10/10/25 at 8:23:30 AM (CDT). Other information about this vehicle, including problems, may not have been reported to CARFAX. Use this report as one important tool, along with a vehicle inspection and test drive, to make a better decision about your next used car.

## CARFAX Accident / Damage History

Not all accidents / issues are reported to CARFAX

### Event 1

02/24/2020

#### Accident reported: moderate damage

- Vehicle involved in a rear-end collision with another motor vehicle
- Airbags did not deploy

[View More Details >](#)

#### Damage Severity Scale

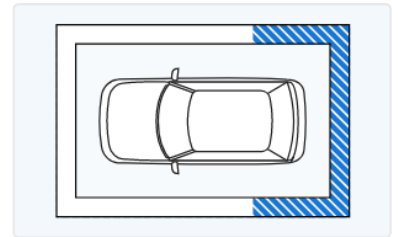

### Event 2

01/09/2023

#### Accident reported: minor damage

- Functional damage reported
- Airbags did not deploy

[View More Details >](#)

#### Damage Severity Scale

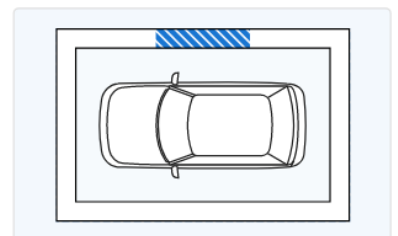
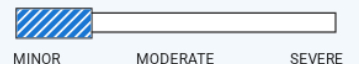

### Event 3

07/16/2025

**Accident reported**

- Vehicle involved in a rear-end collision
- Functional damage reported
- Vehicle towed
- Airbag deployed

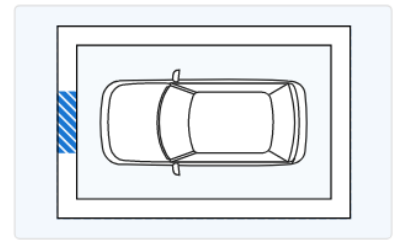
[View More Details >](#)[Show More ▾](#)

<b>CARFAX</b> Additional History Not all accidents / issues are reported to CARFAX	Owner 1	Owner 2
<b>Total Loss</b> ⓘ Total Loss Reported: 09/29/2025.	✓	<a href="#">Total Loss Reported</a>
<b>Structural Damage</b> ⓘ CARFAX recommends that you have this vehicle inspected by a collision repair specialist.	✓	✓
<b>Airbag Deployment</b> ⓘ Airbag deployment reported: 07/16/2025.	✓	<a href="#">Airbag Deployment</a>
<b>Odometer Check</b> ⓘ No indication of an odometer rollback.	✓	✓
<b>Accident / Damage</b> ⓘ DMV title problems reported. Accidents reported: 02/24/2020, 01/09/2023, and 07/16/2025.	<a href="#">Accident Reported</a>	<a href="#">Severe Damage</a>
<b>Manufacturer Recall</b> ⓘ No open recalls reported to CARFAX.	No Recalls Reported	No Recalls Reported
<b>Basic Warranty</b> ⓘ Original manufacturer warranty likely voided by manufacturer.	✓	<b>Warranty Voided</b>

<b>CARFAX</b> Title History	Owner 1	Owner 2
<b>Damage Brands</b> ⓘ Salvage   Junk   Rebuilt   Fire   Flood   Hail   Lemon	No Problem	<b>Alert!</b> Problem Found
<b>Odometer Brands</b> ⓘ Not Actual Mileage   Exceeds Mechanical Limits	No Problem	No Problem



**ALERT!** - Severe problems were reported by a state Department of Motor Vehicles (DMV). This vehicle does not qualify for the CARFAX Buyback Guarantee.





<b>CARFAX</b> Ownership History The number of owners is estimated	Owner 1	Owner 2
Year purchased	2018	2021
Type of owner	Personal lease	Personal
Estimated length of ownership	2 yrs. 11 mo.	3 yrs. 11 mo.

Estimated length of ownership	2 yrs. 11 mo.	3 yrs. 11 mo.
Owned in the following states/provinces	Florida	Georgia
Estimated miles driven per year	11,417/yr	9,793/yr
Last reported odometer reading	32,940	68,033

**CARFAX** Detailed History

[Glossary](#)

 **Owner 1** Personal Lease Vehicle  
Purchased: 2018 11,417 mi/yr

Date	Mileage	Source	Comments
Not Reported		NICB	<b>Vehicle manufactured and shipped to original dealer</b>
08/16/2018 	9	Audi Pembroke Pines Pembroke Pines, FL 888-378-8973 audipembrokepines.com/  ★ 4.7 / 5.0 <a href="#">311 Verified Reviews</a> ♥ 156 Customer Favorites	<b>Vehicle serviced</b> -Pre-delivery inspection completed
09/06/2018 	24	Audi Pembroke Pines Pembroke Pines, FL 888-378-8973 audipembrokepines.com/  ★ 4.7 / 5.0 <a href="#">311 Verified Reviews</a> ♥ 156 Customer Favorites	<b>Vehicle serviced</b>
10/02/2018 	27	Audi Pembroke Pines Pembroke Pines, FL 888-378-8973 audipembrokepines.com/  ★ 4.7 / 5.0 <a href="#">311 Verified Reviews</a> ♥ 156 Customer Favorites	<b>Vehicle serviced</b>
10/26/2018 	38	Audi Pembroke Pines Pembroke Pines, FL 888-378-8973 audipembrokepines.com/  ★ 4.7 / 5.0 <a href="#">311 Verified Reviews</a> ♥ 156 Customer Favorites	<b>Vehicle serviced</b>
11/05/2018		Florida Motor Vehicle Dept. Delray Beach, FL Title #0132816646	<b>Vehicle purchase reported</b> - Title issued or updated - Registration issued or renewed - First owner reported - Titled or registered as personal lease vehicle - Vehicle color noted as Black
11/20/2018 	301	Audi Pembroke Pines Pembroke Pines, FL 888-378-8973 audipembrokepines.com/  ★ 4.7 / 5.0 <a href="#">311 Verified Reviews</a> ♥ 156 Customer Favorites	<b>Vehicle serviced</b>

12/21/2018

2,226



Audi Coral Springs  
Coral Springs, FL  
954-509-8960  
audicoralsprings.com

★ 4.6 / 5.0

[403 Verified Reviews](#)

♥ 1,401 Customer Favorites

**Vehicle serviced**

- Maintenance inspection completed
- One tire balanced
- One tire mounted

05/22/2019

10,095



Audi Coral Springs  
Coral Springs, FL  
954-509-8960  
audicoralsprings.com

★ 4.6 / 5.0

[403 Verified Reviews](#)

♥ 1,401 Customer Favorites

**Vehicle serviced**

- Maintenance inspection completed
- 10,000 mile service performed
- Tires rotated
- Two tires balanced
- Two tires mounted
- Two tires replaced

06/14/2019

10,892



Audi Coral Springs  
Coral Springs, FL  
954-509-8960  
audicoralsprings.com

★ 4.6 / 5.0

[403 Verified Reviews](#)

♥ 1,401 Customer Favorites

**Vehicle serviced**

- Maintenance inspection completed
- One tire balanced
- One tire mounted
- Tire condition and pressure checked
- Tire(s) replaced
- Two tires balanced
- Two tires mounted
- Two tires replaced

08/16/2019

Florida  
Motor Vehicle Dept.  
Boynton Beach, FL  
Title #0132816646

**Registration issued or renewed**

- Registration updated when owner moved the vehicle to a new location
- Vehicle color noted as Black

12/30/2019

19,445



Audi Coral Springs  
Coral Springs, FL  
954-509-8960  
audicoralsprings.com

★ 4.6 / 5.0

[403 Verified Reviews](#)

♥ 1,401 Customer Favorites

**Vehicle serviced**

- Maintenance inspection completed
- Fuel system cleaned/serviced
- Oil and filter changed
- Tires rotated

02/24/2020







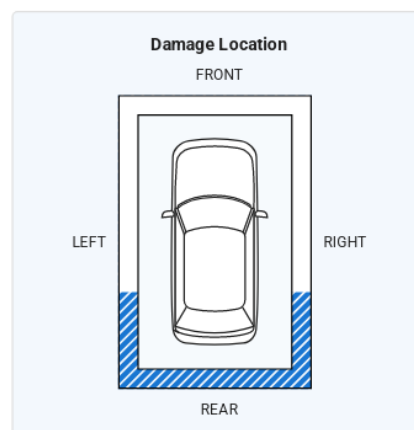
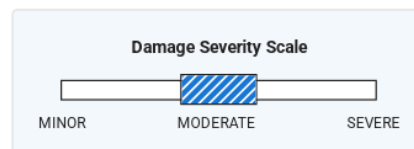

Damage Report

**Accident reported: moderate damage** ⓘ

- Vehicle involved in a rear-end collision with another motor vehicle
- Damage to right rear
- Damage to rear
- Damage to left rear
- Airbags did not deploy





**CARFAX HAS THE MOST ACCIDENT & DAMAGE INFORMATION**

06/19/2020 	21,638	Audi West Palm Beach West Palm Beach, FL 877-733-1222 bramaudi.com  ★ 4.5 / 5.0 <a href="#">409 Verified Reviews</a> ♥ 151 Customer Favorites	<b>Vehicle serviced</b> - Alignment performed
07/02/2020		Florida Motor Vehicle Dept. Boynton Beach, FL Title #0132816646	<b>Registration issued or renewed</b> - Vehicle color noted as Black
09/08/2020		Florida Motor Vehicle Dept. Boynton Beach, FL Title #0132816646	<b>Registration issued or renewed</b> - Vehicle color noted as Black
01/18/2021 	26,453	Audi Coral Springs Coral Springs, FL 954-509-8960 audicoralsprings.com  ★ 4.6 / 5.0 <a href="#">403 Verified Reviews</a> ♥ 1,401 Customer Favorites	<b>Vehicle serviced</b> - Maintenance inspection completed - Oil and filter changed
03/02/2021 	28,492	Apex Automotive Lake Worth, FL 561-432-9200 apexautomotive.com/  ★ 4.9 / 5.0 <a href="#">258 Verified Reviews</a> ♥ 1,315 Customer Favorites	<b>Vehicle serviced</b> - Four tires mounted - Tire pressure monitoring system serviced - Tire(s) balanced - Tire(s) replaced
07/26/2021	32,763	Georgia Inspection Station	<b>Passed emissions inspection</b>
07/28/2021 		Audi Coral Springs Coral Springs, FL 954-509-8960 audicoralsprings.com  ★ 4.6 / 5.0 <a href="#">403 Verified Reviews</a> ♥ 1,401 Customer Favorites	<b>Vehicle serviced</b>
07/30/2021 		Marietta Auto Sales Marietta, GA 770-973-8077 mariettaautosales.com/  ★ 3.3 / 5.0 <a href="#">53 Verified Reviews</a>	<b>Vehicle serviced</b>
09/02/2021 		Marietta Auto Sales Marietta, GA 770-973-8077 mariettaautosales.com/  ★ 3.3 / 5.0 <a href="#">53 Verified Reviews</a>	<b>Vehicle serviced</b>
09/23/2021 	32,940	Marietta Auto Sales Marietta, GA 770-973-8077 mariettaautosales.com/  ★ 3.3 / 5.0 <a href="#">53 Verified Reviews</a>	<b>Vehicle serviced</b> - Brakes checked - Brake pads replaced - Rear brake pads replaced - Rear brake rotor(s) replaced

 **Owner 2**  
Purchased: 2021

Personal Vehicle  
9,793 mi/yr

Date	Mileage	Source	Comments
10/07/2021		Georgia Motor Vehicle Dept.	<b>Vehicle purchase reported</b>
10/18/2021		Georgia Motor Vehicle Dept. Douglasville, GA Title #770094215735962	<b>Title issued or updated</b> - Title or registration issued - New owner reported - Loan or lien reported - Vehicle color noted as Black
01/10/2022 	36,345	Audi Marietta Marietta, GA 770-859-2834 jimellisaudimarietta.com  ★ 4.7 / 5.0 <a href="#">262 Verified Reviews</a> ♥ 12 Customer Favorites	<b>Vehicle serviced</b> - Maintenance inspection completed - Wheel locks installed
04/23/2022 	38,757	Audi North Atlanta Roswell, GA 770-327-1179 audinorthatlanta.com/  ★ 4.5 / 5.0 <a href="#">304 Verified Reviews</a> ♥ 236 Customer Favorites	<b>Vehicle serviced</b> - Maintenance inspection completed - 40,000 mile service performed - Brake fluid flushed/changed - Four wheel alignment performed - Oil and filter changed
05/17/2022 	39,285	Audi North Atlanta Roswell, GA 770-327-1179 audinorthatlanta.com/  ★ 4.5 / 5.0 <a href="#">304 Verified Reviews</a> ♥ 236 Customer Favorites	<b>Vehicle serviced</b>
11/08/2022	46,284	Georgia Inspection Station	<b>Passed emissions inspection</b>
11/08/2022		Georgia Motor Vehicle Dept. Douglasville, GA Title #770094215735962	<b>Registration issued or renewed</b> - Loan or lien reported - Vehicle color noted as Black

01/09/2023  



Damage Report



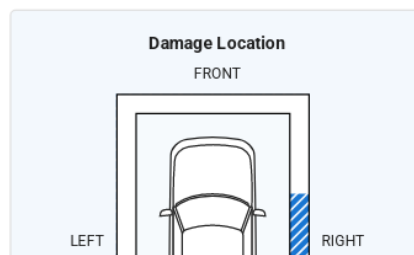
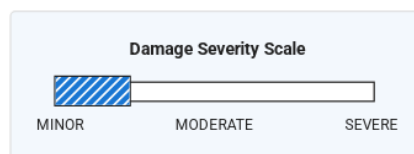

**Accident reported: minor damage** ⓘ

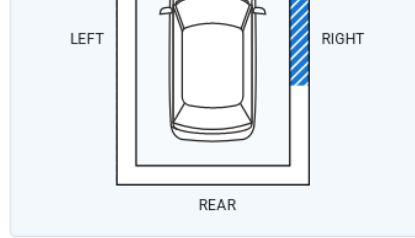
- Damage to right side
- Functional damage reported
- Airbags did not deploy



**CARFAX HAS THE MOST  
ACCIDENT & DAMAGE  
INFORMATION**



08/04/2023 	51,870	Audi North Atlanta Roswell, GA 770-327-1179 audinorthatlanta.com/ ★ 4.5 / 5.0 <a href="#">304 Verified Reviews</a> ♥ 236 Customer Favorites	<b>Vehicle serviced</b> - Maintenance inspection completed - 50,000 mile service performed - Engine checked - Oil and filter changed
08/11/2023 	51,966	Southern Tire Mart Forest Park, GA 404-608-8111 stmtires.com/ ★ 4.9 / 5.0 <a href="#">11 Verified Reviews</a>	<b>Vehicle serviced</b> - One tire balanced - Tire condition and pressure checked - Tire(s) balanced - Tire(s) replaced
10/24/2023	54,179	Georgia Inspection Station	<b>Passed emissions inspection</b>
10/27/2023		Georgia Motor Vehicle Dept. Douglasville, GA Title #770094215735962	<b>Registration issued or renewed</b> - Loan or lien reported - Vehicle color noted as Black
10/26/2024	62,584	Georgia Inspection Station	<b>Passed emissions inspection</b>
10/26/2024		Georgia Motor Vehicle Dept. Douglasville, GA Title #770094215735962	<b>Registration issued or renewed</b> - Loan or lien reported - Vehicle color noted as Black
04/01/2025 	65,846	Take 5 Oil Change Union City, GA 770-954-8889 take5oilchange.com ★ 4.6 / 5.0 <a href="#">189 Verified Reviews</a> ♥ 1 Customer Favorite	<b>Vehicle serviced</b> - Tire condition and pressure checked
04/05/2025 	68,033	Audi North Atlanta Roswell, GA 770-327-1179 audinorthatlanta.com/ ★ 4.5 / 5.0 <a href="#">304 Verified Reviews</a> ♥ 236 Customer Favorites	<b>Vehicle serviced</b> - Maintenance inspection completed - Oil and filter changed

07/16/2025  

Damage Report

**Accident reported**

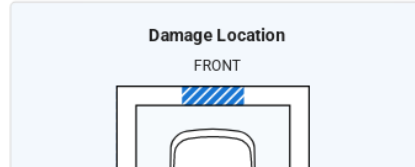

- Vehicle involved in a rear-end collision
- Damage to front
- Functional damage reported
- Vehicle towed
- Airbag deployed

[CARFAX Airbag Tips](#)

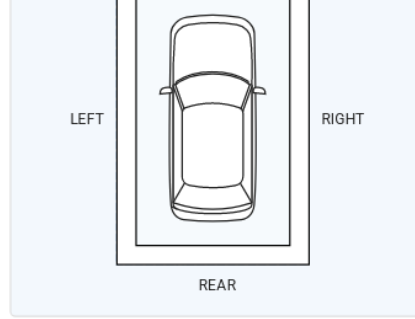

**CARFAX HAS THE MOST ACCIDENT & DAMAGE INFORMATION**



09/23/2025	Georgia Motor Vehicle Dept.	<b>Vehicle purchase reported</b>
09/29/2025 	Damage Report	<b>TOTAL LOSS VEHICLE</b>
		There are many reasons an insurance company will declare a vehicle a total loss. Have this vehicle inspected by a qualified technician before you buy. <a href="#">Learn More</a>
09/29/2025	Georgia Motor Vehicle Dept.	<b>Title or registration issued to insurance company</b>
09/29/2025 	Georgia Motor Vehicle Dept. Cleveland, OH Title #400249258149964	<b>SALVAGE TITLE/CERTIFICATE ISSUED</b> - Vehicle color noted as Black
10/10/2025	Audi	<b>Connect Service available with subscription</b>  Connect offers services to enhance navigation, infotainment, and peace of mind  <a href="#">Learn more</a>

Have Questions? Consumers, please visit our Help Center at [www.carfax.com](http://www.carfax.com). Dealers or Subscribers, please visit our Help Center at [www.carfaxonline.com](http://www.carfaxonline.com).

Follow Us:  [facebook.com/CARFAX](https://facebook.com/CARFAX)  [@CARFAXinc](https://twitter.com/CARFAXinc)  [About CARFAX](#)

CARFAX DEPENDS ON ITS SOURCES FOR THE ACCURACY AND RELIABILITY OF ITS INFORMATION. THEREFORE, NO RESPONSIBILITY IS ASSUMED BY CARFAX OR ITS AGENTS FOR ERRORS OR OMISSIONS IN THIS REPORT. CARFAX FURTHER EXPRESSLY DISCLAIMS ALL WARRANTIES, EXPRESS OR IMPLIED, INCLUDING ANY IMPLIED WARRANTIES OF MERCHANTABILITY OR FITNESS FOR A PARTICULAR PURPOSE.

© 2025 CARFAX, Inc., part of S&P Global. All rights reserved.  
10/10/25 8:23:30 AM (CDT)

I have reviewed and received a copy of the CARFAX Vehicle History Report for this 2018 AUDI SQ5 vehicle (VIN: WA1C4AFY6J2211529), which is based on information supplied to CARFAX and available as of 10/10/25 at 9:23 AM (EDT).

\_\_\_\_\_  
Customer Signature

\_\_\_\_\_  
Date

\_\_\_\_\_  
Dealer Signature

\_\_\_\_\_  
Date