

CARFAX History-Based Value Report

[Hide](#)

\$12,050

CARFAX Retail Value

Retail
 Wholesale

History events affecting this vehicle's value

- Personal Vehicle
- Salvage Brand

CARFAX Vehicle History Report™

US \$44.99

2014 AUDI Q5 2.0T QUATTRO PREMIUM

VIN: WA1CFAFPXEA039227
 4 DOOR WAGON/SPORT UTILITY
 2.0L I4 F DOHC 16V
 FLEX FUEL
 ALL WHEEL DRIVE

Branded Title: Salvage >

11 Service history records >

2 Previous owners >

Personal vehicle >

Last owned in California >

49,982 Last reported odometer reading >

CARFAX HAS THE MOST ACCIDENT & DAMAGE INFORMATION



This CARFAX Vehicle History Report is based only on [information](#) supplied to CARFAX and available as of 9/15/25 at 5:09:38 AM (CDT). Other information about this vehicle, including problems, may not have been reported to CARFAX. Use this report as one important tool, along with a vehicle inspection and test drive, to make a better decision about your next used car.

CARFAX Accident / Damage History

Not all accidents / issues are reported to CARFAX

Event 1

07/10/2015

Damage reported: very minor damage

[View More Details >](#)

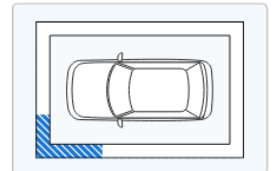
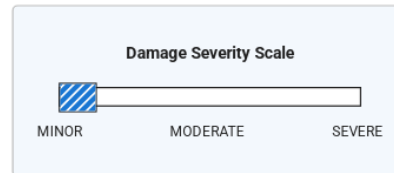

Event 2

03/21/2016

Damage reported: minor damage

[View More Details >](#)

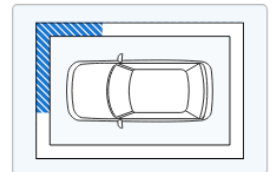
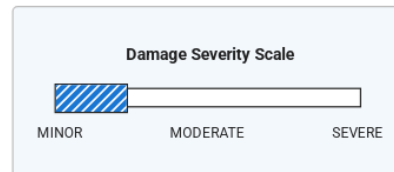

Event 3

06/26/2020

Damage reported: minor damage

[View More Details >](#)

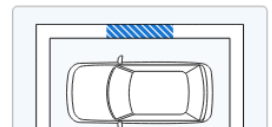
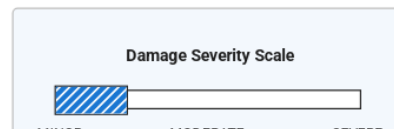

[View More Details >](#)

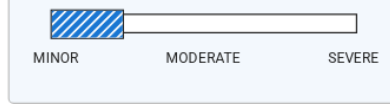

[Show More >](#)

CARFAX Additional History Not all accidents / issues are reported to CARFAX	Owner 1	Owner 2
Total Loss ⓘ No total loss reported to CARFAX.	✔ No Issues Reported	✔ No Issues Reported
Structural Damage ⓘ CARFAX recommends that you have this vehicle inspected by a collision repair specialist.	✔ No Issues Reported	✔ No Issues Reported
Airbag Deployment ⓘ No airbag deployment reported to CARFAX.	✔ No Issues Reported	✔ No Issues Reported
Odometer Check ⓘ No indication of an odometer rollback.	✔ No Issues Indicated	✔ No Issues Indicated
Accident / Damage ⓘ DMV title problems reported. Damage reported: 07/10/2015, 03/21/2016, and 06/26/2020. Accident reported: 08/25/2025.	Damage Reported	Severe Damage
Manufacturer Recall ⓘ No open recalls reported to CARFAX.	✔ No Recalls Reported	✔ No Recalls Reported
Basic Warranty ⓘ Original manufacturer warranty likely voided by manufacturer.	✔ Warranty Active	Warranty Voided

CARFAX Title History	Owner 1	Owner 2
Damage Brands ⓘ Salvage Junk Rebuilt Fire Flood Hail Lemon	No Problem	Alert! Problem Found
Odometer Brands ⓘ Not Actual Mileage Exceeds Mechanical Limits	No Problem	No Problem

ALERT! - Severe problems were reported by a state Department of Motor Vehicles (DMV). This vehicle does not qualify for the CARFAX Buyback Guarantee.



CARFAX Ownership History The number of owners is estimated	Owner 1	Owner 2
Year purchased	2013	2019
Type of owner	Personal	Personal
Estimated length of ownership	5 yrs. 2 mo.	6 yrs. 8 mo.
Owned in the following states/provinces	Georgia	California
Estimated miles driven per year	5,801/yr	4,175/yr
Last reported odometer reading	26,480	49,982

CARFAX Detailed History



Glossary

Owner 1
Purchased: 2013

Personal Vehicle
5,801 mi/yr

Date	Mileage	Source	Comments
Not Reported		NICB	Vehicle manufactured and shipped to Georgia
09/23/2013		Audi North Atlanta Roswell, GA 770-327-1179 audinorthatlanta.com/ ★ 4.5 / 5.0 299 Verified Reviews ✓ ♥ 237 Customer Favorites	Vehicle offered for sale
10/21/2013	11	Audi North Atlanta Roswell, GA 770-327-1179 audinorthatlanta.com/ ★ 4.5 / 5.0 299 Verified Reviews ✓ ♥ 237 Customer Favorites	 Vehicle serviced - Pre-delivery inspection completed - Wheel locks installed - Vehicle washed/detailed
10/22/2013		Georgia Motor Vehicle Dept.	Vehicle purchase reported - Titled or registered as personal vehicle
10/29/2013		Georgia Motor Vehicle Dept. Snellville, GA Title #771326133020961	Title issued or updated - First owner reported - Loan or lien reported - Vehicle color noted as Black
04/18/2014		Georgia Motor Vehicle Dept. Snellville, GA Title #771326133020961	Registration issued or renewed - Loan or lien reported - Vehicle color noted as Black
09/05/2014	5,128	Audi North Atlanta Roswell, GA 770-327-1179 audinorthatlanta.com/ ★ 4.5 / 5.0 299 Verified Reviews ✓ ♥ 237 Customer Favorites	 Vehicle serviced - 5,000 mile service performed - Brakes checked - Tire condition and pressure checked
04/21/2015		Georgia Motor Vehicle Dept. Snellville, GA Title #771326133020961	Registration issued or renewed - Loan or lien reported - Vehicle color noted as Black

07/10/2015 Damage Report

 **Damage reported: very minor damage** 
- Damage to left front

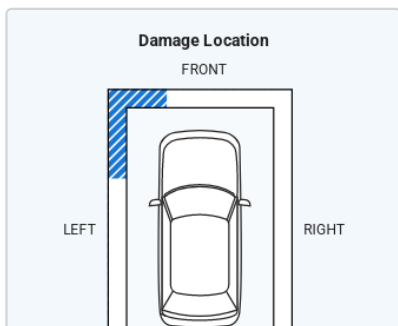
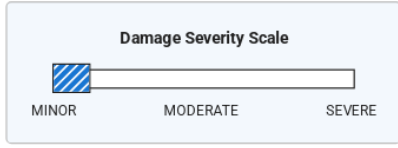

CARFAX HAS THE MOST ACCIDENT & DAMAGE INFORMATION

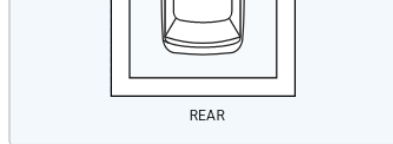

09/14/2015

12,856

Audi North Atlanta
Roswell, GA
770-327-1179
audinorthatlanta.com/

★ 4.5 / 5.0 [299 Verified Reviews](#) ✓

♥ 237 Customer Favorites



Vehicle serviced

- 15,000 mile service performed
- Brakes checked
- Tire condition and pressure checked

03/21/2016

Damage Report



Damage reported: minor damage ⓘ

- Damage to front
- Damage to right front

**CARFAX HAS THE MOST
ACCIDENT & DAMAGE
INFORMATION**

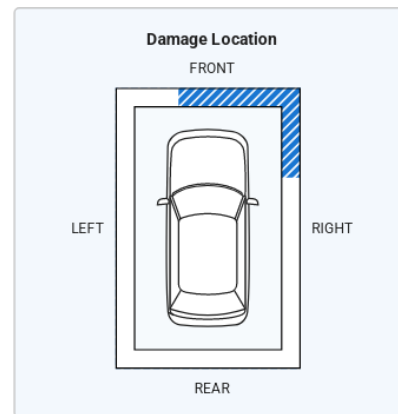
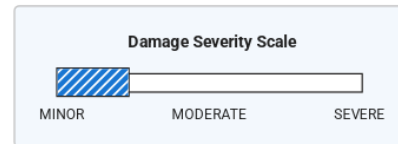

04/04/2016

Georgia
Motor Vehicle Dept.
Snellville, GA
Title #771326133020961

Registration issued or renewed

- Loan or lien reported
- Vehicle color noted as Black

04/27/2016

16,388

Audi North Atlanta
Roswell, GA
770-327-1179
audinorthatlanta.com/

★ 4.5 / 5.0 [299 Verified Reviews](#) ✓

♥ 237 Customer Favorites



Vehicle serviced

- Brakes checked
- Tire condition and pressure checked

10/06/2016

18,043

Audi North Atlanta
Roswell, GA
770-327-1179
audinorthatlanta.com/

★ 4.5 / 5.0 [299 Verified Reviews](#) ✓

♥ 237 Customer Favorites



Vehicle serviced

- 25,000 mile service performed
- Brakes checked
- Brake fluid flushed/changed
- Tire condition and pressure checked
- Wheels checked

04/24/2017

22,064

Georgia
Inspection Station

Passed emissions inspection

04/26/2017

Georgia
Motor Vehicle Dept.
Snellville, GA
Title #771326133020961

Registration issued or renewed

- Loan or lien reported
- Vehicle color noted as Black

04/26/2018

26,283

Georgia
Inspection Station

Passed emissions inspection

04/30/2018

Georgia
Motor Vehicle Dept.
Snellville, GA
Title #771326133020961

Registration issued or renewed

- Loan or lien reported
- Vehicle color noted as Black

Snellville, GA
Title #771326133020961

- Vehicle color noted as Black

05/15/2018 26,480 Audi North Atlanta
Roswell, GA
770-327-1179
audinorthatlanta.com/
★ 4.5 / 5.0 [299 Verified Reviews](#) ✓
♥ 237 Customer Favorites



Vehicle serviced
- 35,000 mile service performed
- Brakes checked
- Tire condition and pressure checked

Owner 2
Purchased: 2019

Personal Vehicle
4,175 mi/yr

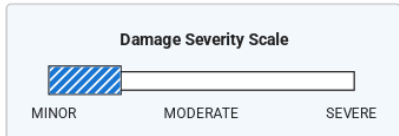
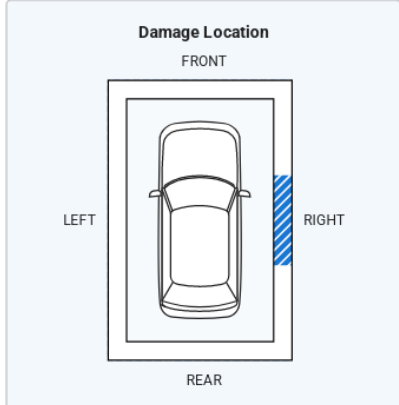
Date	Mileage	Source	Comments
01/07/2019	29,449	California Motor Vehicle Dept. San Jose, CA	Odometer reading reported
01/18/2019		California Inspection Station	Passed emissions inspection
01/23/2019		California Motor Vehicle Dept. San Jose, CA	Title issued or updated - New owner reported
06/06/2019	32,083	Audi Fremont Fremont, CA 510-403-3700 audifremont.com/ ★ 4.6 / 5.0 210 Verified Reviews ✓ ♥ 78 Customer Favorites	Vehicle serviced - Maintenance inspection completed - Tire condition and pressure checked - Vehicle washed/detailed
06/15/2019	32,299	Audi Fremont Fremont, CA 510-403-3700 audifremont.com/ ★ 4.6 / 5.0 210 Verified Reviews ✓ ♥ 78 Customer Favorites	Vehicle serviced - Maintenance inspection completed - 45,000 mile service performed - Tire condition and pressure checked - Vehicle washed/detailed
06/26/2020		Damage Report	Damage reported: minor damage - Damage to right side <div style="display: flex; align-items: center;"> <div style="flex: 1;"> <p>CARFAX HAS THE MOST ACCIDENT & DAMAGE INFORMATION</p>  </div> <div style="flex: 1;"> <p>Damage Severity Scale</p>  <p>MINOR MODERATE SEVERE</p> </div> <div style="flex: 1;"> <p>Damage Location</p>  <p>FRONT LEFT RIGHT REAR</p> </div> </div>
07/30/2020	42,149	Audi Fremont Fremont, CA 510-403-3700 audifremont.com/ ★ 4.6 / 5.0 210 Verified Reviews ✓ ♥ 78 Customer Favorites	Vehicle serviced - Maintenance inspection completed - Oil and filter changed - Tire condition and pressure checked - Vehicle washed/detailed

★ 4.6 / 5.0 210 Verified Reviews ✓
♥ 78 Customer Favorites

- vehicle washed/detailed

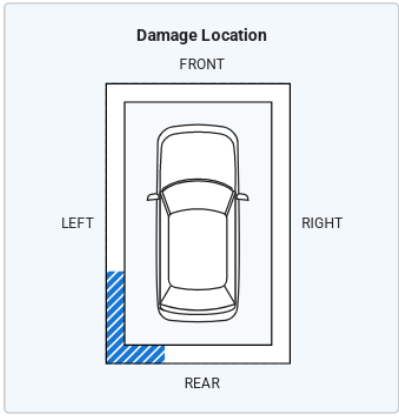
10/20/2021		California Motor Vehicle Dept. Belmont, CA		Registration updated when owner moved the vehicle to a new location
04/26/2022	45,701	California Inspection Station		Passed emissions inspection
04/27/2022	45,730	Audi Fremont Fremont, CA 510-403-3700 audifremont.com/ ★ 4.6 / 5.0 210 Verified Reviews ✓ ♥ 78 Customer Favorites	🔧	Vehicle serviced - Maintenance inspection completed - Tire condition and pressure checked - Vehicle washed/detailed
09/15/2023	49,001	Audi Fremont Fremont, CA 510-403-3700 audifremont.com/ ★ 4.6 / 5.0 210 Verified Reviews ✓ ♥ 78 Customer Favorites	🔧	Vehicle serviced - Maintenance inspection completed - Air filter replaced - Oil and filter changed - Tire condition and pressure checked - Vehicle washed/detailed
12/07/2023	49,982	California Inspection Station		Passed emissions inspection
08/25/2025		Damage Report	⚠️	Accident reported - Damage to left rear
				
09/10/2025		Damage Report	⚠️	SALVAGE TITLE/CERTIFICATE ISSUED

**CARFAX HAS THE MOST
ACCIDENT & DAMAGE
INFORMATION**

Have Questions? Consumers, please visit our Help Center at www.carfax.com. Dealers or Subscribers, please visit our Help Center at www.carfaxonline.com.

Accident Indicator

CARFAX receives information about accidents in all 50 states, the District of Columbia and Canada.

Not every accident is reported to CARFAX. As details about the accident become available, those additional details are added to the CARFAX Vehicle History Report. CARFAX recommends that you have this vehicle inspected by a qualified mechanic.

- According to the National Safety Council, Injury Facts, 2021 edition, 5% of the 276 million registered vehicles in the U.S. were involved in an accident in 2019. Over 77% of these were considered minor or moderate.
- This CARFAX Vehicle History Report is based only on information supplied to CARFAX and available as of 9/15/25 at 5:09:38 AM (CDT). Other information about this vehicle, including problems, may not have been reported to CARFAX. Use this report as one important tool, along with a vehicle inspection and test drive, to make a better decision about your next used car.

Damage Indicator

Damage can be a result of many different types of events. Examples include contact with objects (other cars, trees, traffic signs, road debris, etc), vandalism, or weather-

Damage Indicator

Damage can be a result of many different types of events. Examples include contact with objects (other cars, trees, traffic signs, road debris, etc), vandalism, or weather-related events. Not every damage event is reported to CARFAX. As details about the damage event become available, those additional details are added to the CARFAX Vehicle History Report. CARFAX recommends that you have this vehicle inspected by a qualified mechanic.

- This CARFAX Vehicle History Report is based only on information supplied to CARFAX and available as of 9/15/25 at 5:09:38 AM (CDT). Other information about this vehicle, including problems, may not have been reported to CARFAX. Use this report as one important tool, along with a vehicle inspection and test drive, to make a better decision about your next used car.

Damage Severity

Damage events result in one of the following severity levels:

- Minor: Generally, minor damage is cosmetic (including dents or scratches), may only require reconditioning, and typically does not compromise a vehicle's operation and/or safety.
- Moderate: Moderate damage may affect multiple components of the vehicle and may impair the vehicle's operation and/or safety.
- Severe: Severe damage usually affects multiple components of the vehicle and is likely to compromise the vehicle's operation and/or safety.

CARFAX recommends getting a pre-purchase inspection at a certified collision repair facility.

First Owner

When the first owner(s) obtains a title from a Department of Motor Vehicles as proof of ownership.

New Owner Reported

When a vehicle is sold to a new owner, the Title must be transferred to the new owner(s) at a Department of Motor Vehicles.

Ownership History

CARFAX defines an owner as an individual or business that possesses and uses a vehicle. Not all title transactions represent changes in ownership. To provide estimated number of owners, CARFAX proprietary technology analyzes all the events in a vehicle history. Estimated ownership is available for vehicles manufactured after 1991 and titled solely in the US including Puerto Rico. Dealers sometimes opt to take ownership of a vehicle and are required to in the following states: Maine, Massachusetts, New Jersey, Ohio, Oklahoma, Pennsylvania and South Dakota. Please consider this as you review a vehicle's estimated ownership history.

Salvage Title

A Salvage Title is issued on a vehicle damaged to the extent that the cost of repairing the vehicle exceeds approximately 75% of its pre-damage value. This damage threshold may vary by state. Some states treat Junk titles the same as Salvage but the majority use this title to indicate that a vehicle is not road worthy and cannot be titled again in that state. The following eleven states also use Salvage titles to identify stolen vehicles - AZ, FL, GA, IL, MD, MN, NJ, NM, NY, OK and OR.

Title Issued

A state issues a title to provide a vehicle owner with proof of ownership. Each title has a unique number. Each title or registration record on a CARFAX report does not necessarily indicate a change in ownership. In Canada, a registration and bill of sale are used as proof of ownership.

Follow Us:  facebook.com/CARFAX  [@CARFAXinc](https://twitter.com/CARFAXinc)  [About CARFAX](#)

CARFAX DEPENDS ON ITS SOURCES FOR THE ACCURACY AND RELIABILITY OF ITS INFORMATION. THEREFORE, NO RESPONSIBILITY IS ASSUMED BY CARFAX OR ITS AGENTS FOR ERRORS OR OMISSIONS IN THIS REPORT. CARFAX FURTHER EXPRESSLY DISCLAIMS ALL WARRANTIES, EXPRESS OR IMPLIED, INCLUDING ANY IMPLIED WARRANTIES OF MERCHANTABILITY OR FITNESS FOR A PARTICULAR PURPOSE.

© 2025 CARFAX, Inc., part of S&P Global. All rights reserved.
9/15/25 5:09:38 AM (CDT)

I have reviewed and received a copy of the CARFAX Vehicle History Report for this 2014 AUDI Q5 vehicle (VIN: WA1CFAFPXE039227), which is based on information supplied to CARFAX and available as of 9/15/25 at 6:09 AM (EDT).

Customer Signature

Date

Dealer Signature

Date

