

## 2019 AUDI Q3 QUATTRO S LINE PREMIUM 45 TFSI

VIN: WA1DECF37K1086355  
 4 DOOR WAGON/SPORT UTILITY  
 2.0L I4 F DOHC 16V  
 GASOLINE  
 ALL WHEEL DRIVE

Branded Title: Salvage >

13 Service history records >

2 Previous owners >

Types of owners: Corporate fleet, Personal >

Last owned in Florida >

64,080 Last reported odometer reading >

This CARFAX Vehicle History Report is based only on [information](#) supplied to CARFAX and available as of 11/13/25 at 8:38:37 AM (CST). Other information about this vehicle, including problems, may not have been reported to CARFAX. Use this report as one important tool, along with a vehicle inspection and test drive, to make a better decision about your next used car.

## Accident / Damage History

Not all accidents / issues are reported to CARFAX

### Event 1

11/13/2020

#### Accident reported: minor damage

- Vehicle involved in a rear-end collision with another motor vehicle
- Airbags did not deploy

[View More Details >](#)

#### Damage Severity Scale

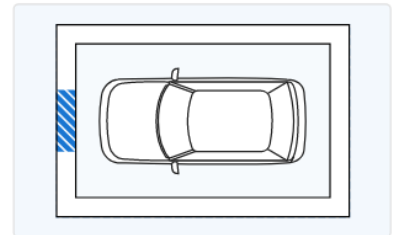
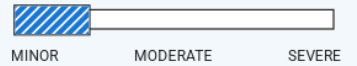

### Event 2

02/06/2023

#### Damage reported: minor damage

#### Damage Severity Scale

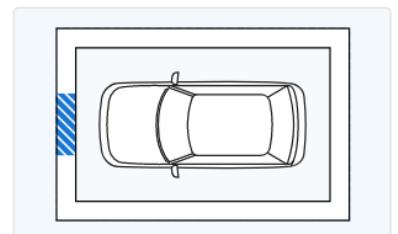
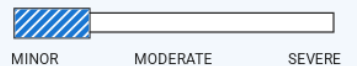

### Event 3

04/25/2023

#### Accident reported

- Vehicle involved in a rear-end collision with another motor vehicle
- Airbags did not deploy

[View More Details >](#)

Show More ▾

<b>CARFAX</b> Additional History <small>Not all accidents / issues are reported to CARFAX</small>	Owner 1	Owner 2
<b>Total Loss</b> ⓘ No total loss reported to CARFAX.	✓	✓
<b>Structural Damage</b> ⓘ CARFAX recommends that you have this vehicle inspected by a collision repair specialist.	✓	✓
<b>Airbag Deployment</b> ⓘ No airbag deployment reported to CARFAX.	✓	✓
<b>Odometer Check</b> ⓘ No indication of an odometer rollback.	✓	✓
<b>Accident / Damage</b> ⓘ DMV title problems reported. Accidents reported: 11/13/2020, 04/25/2023, 05/20/2024, and 08/24/2025. Damage reported: 02/06/2023.	✓	<a href="#">Severe Damage</a>
<b>Manufacturer Recall</b> ⓘ No open recalls reported to CARFAX.	No Recalls Reported	No Recalls Reported
<b>Basic Warranty</b> ⓘ Original manufacturer warranty likely voided by manufacturer.	✓	<b>Warranty Voided</b>





<b>CARFAX</b> Title History	Owner 1	Owner 2
<b>Damage Brands</b> ⓘ Salvage   Junk   Rebuilt   Fire   Flood   Hail   Lemon	No Problem	<b>Alert!</b> Problem Found
<b>Odometer Brands</b> ⓘ Not Actual Mileage   Exceeds Mechanical Limits	No Problem	No Problem





**ALERT!** - Severe problems were reported by a state Department of Motor Vehicles (DMV). This vehicle does not qualify for the CARFAX Buyback Guarantee.

<b>CARFAX</b> Ownership History <small>The number of owners is estimated</small>	Owner 1	Owner 2
Year purchased	2019	2020
Type of owner	Corporate fleet	Personal
Estimated length of ownership	2 months	5 yrs. 1 mo.
Owned in the following states/provinces	Florida	Florida
Estimated miles driven per year	—	16,470/yr
Last reported odometer reading	7,826	64,080

 **Owner 1**  
Purchased: 2019

Corporate Fleet Vehicle

Date	Mileage	Source	Comments
Not Reported		NICB	<b>Vehicle manufactured and shipped to original dealer</b>
09/07/2019 		Audi North Miami Miami, FL 305-952-5900 audinorthmiami.com  ★ 4.6 / 5.0 <a href="#">351 Verified Reviews</a> ♥ 226 Customer Favorites	<b>Vehicle serviced</b> - Pre-delivery inspection completed - Nitrogen fill tires - Wheel locks installed
10/23/2019	10	Florida Motor Vehicle Dept. Miami, FL Title #0136515898	<b>Vehicle purchase reported</b> - Title issued or updated - Registration issued or renewed - First owner reported - Titled or registered as corporate fleet vehicle - Vehicle color noted as Black
11/19/2019 	15	Audi North Miami Miami, FL 305-952-5900 audinorthmiami.com  ★ 4.6 / 5.0 <a href="#">351 Verified Reviews</a> ♥ 226 Customer Favorites	<b>Vehicle serviced</b>
01/18/2020		Audi North Miami North Miami, FL  ★ 4.6 / 5.0 <a href="#">351 Verified Reviews</a> ♥ 226 Customer Favorites	<b>Vehicle offered for sale</b>
02/25/2020 	3,463	Audi North Miami Miami, FL 305-952-5900 audinorthmiami.com  ★ 4.6 / 5.0 <a href="#">351 Verified Reviews</a> ♥ 226 Customer Favorites	<b>Vehicle serviced</b> - Maintenance inspection completed - Drivability/performance checked
			Looks like this dealer serviced the car in order to prepare it for sale. That's a good thing!
06/05/2020 	5,691	Audi North Miami Miami, FL 305-952-5900 audinorthmiami.com  ★ 4.6 / 5.0 <a href="#">351 Verified Reviews</a> ♥ 226 Customer Favorites	<b>Vehicle serviced</b> - Maintenance inspection completed
06/16/2020		Florida Motor Vehicle Dept. Miami, FL Title #0136515898	<b>Registration issued or renewed</b> - Vehicle color noted as Black

08/05/2020 	7,460	Audi North Miami Miami, FL 305-952-5900 audinorthmiami.com ★ 4.6 / 5.0 <a href="#">351 Verified Reviews</a> ♥ 226 Customer Favorites	<b>Vehicle serviced</b> - Pre-delivery inspection completed - Maintenance inspection completed - 10,000 mile service performed - Brakes checked - Maintenance reminder reset - Oil and filter changed - Rear wiper blade replaced - Tire condition and pressure checked - Tires rotated
08/26/2020		Audi Certified Dealer Miami, FL  Audi Certified pre-owned	<b>Sold as an Audi Certified pre-owned vehicle</b>
08/26/2020		Florida Motor Vehicle Dept. Hollywood, FL Title #0136515898	<b>Vehicle purchase reported</b> - Registration issued or renewed - Vehicle color noted as Black
08/28/2020 	7,461	Audi North Miami Miami, FL 305-952-5900 audinorthmiami.com ★ 4.6 / 5.0 <a href="#">351 Verified Reviews</a> ♥ 226 Customer Favorites	<b>Vehicle serviced</b>
09/11/2020 	7,826	Audi North Miami Miami, FL 305-952-5900 audinorthmiami.com ★ 4.6 / 5.0 <a href="#">351 Verified Reviews</a> ♥ 226 Customer Favorites	<b>Vehicle serviced</b> - Key(s) (re) programmed

 **Owner 2** Personal Vehicle  
Purchased: 2020 16,470 mi/yr





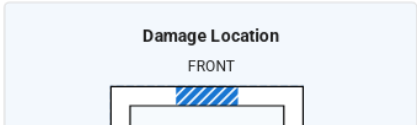
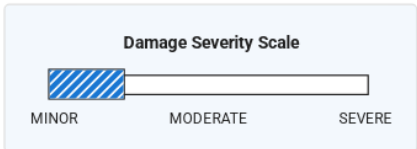

Date	Mileage	Source	Comments
09/18/2020		Florida Motor Vehicle Dept. Hollywood, FL Title #0136515898	<b>Title issued or updated</b> - Registration issued or renewed - New owner reported - Titled or registered as personal vehicle - Loan or lien reported - Vehicle color noted as Black

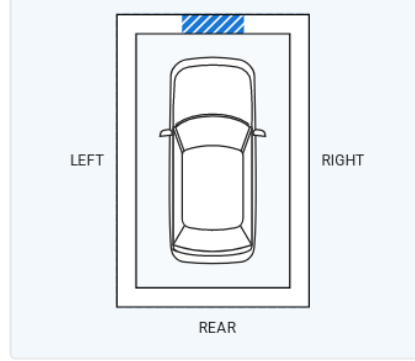
11/13/2020 		Damage Report	<b>Accident reported: minor damage</b> ⓘ - Vehicle involved in a rear-end collision with another motor vehicle - Damage to front - Airbags did not deploy
--	--	---------------	--



**CARFAX HAS THE MOST ACCIDENT & DAMAGE INFORMATION**

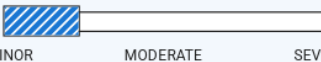

07/26/2021	Florida Motor Vehicle Dept. Hollywood, FL Title #0136515898	<b>Registration issued or renewed</b> - Titled or registered as personal vehicle - Loan or lien reported - Vehicle color noted as Black
10/14/2021 	16,384  Audi North Miami Miami, FL 305-952-5900 audinorthmiami.com  ★ 4.6 / 5.0 <a href="#">351 Verified Reviews</a> ♥ 226 Customer Favorites	<b>Vehicle serviced</b> - Maintenance inspection completed - Engine/powertrain computer/module checked - Engine/powertrain computer/module reprogrammed - Fluids checked - Oil and filter changed - Tire condition and pressure checked - Tire pressure monitoring system reset - Vehicle speed sensor replaced
06/14/2022 	26,269  Audi North Miami Miami, FL 305-952-5900 audinorthmiami.com  ★ 4.6 / 5.0 <a href="#">351 Verified Reviews</a> ♥ 226 Customer Favorites	<b>Vehicle serviced</b> - Maintenance inspection completed - 20,000 mile service performed - Air dam repaired - Antifreeze/coolant checked - Brakes checked - Brake fluid flushed/changed - Cabin air filter replaced/cleaned - Drivability/performance checked - Exterior lights checked - Fluids checked - Headlights adjusted - Headliner removed and reinstalled - Horns checked - Lights checked - Oil and filter changed - Safety restraint system checked - Steering/suspension checked - Sunroof checked - Tire condition and pressure checked - Windshield washer checked - Wipers/washers checked
02/04/2023 	38,980  Audi North Miami Miami, FL 305-952-5900 audinorthmiami.com  ★ 4.6 / 5.0 <a href="#">351 Verified Reviews</a> ♥ 226 Customer Favorites	<b>Vehicle serviced</b> - Maintenance inspection completed - 30,000 mile service performed - Brakes checked - Drivability/performance checked - Oil and filter changed - Tire condition and pressure checked
02/06/2023 	Damage Report	<b>Damage reported: minor damage</b> 
<div style="text-align: center;"> <p><b>Damage Severity Scale</b></p>  </div> 		
04/25/2023 	Damage Report	<b>Accident reported</b> - Vehicle involved in a rear-end collision with another motor vehicle - Damage to front - Airbags did not deploy

- Damage to front
- Airbags did not deploy

**CARFAX HAS THE MOST ACCIDENT & DAMAGE INFORMATION**

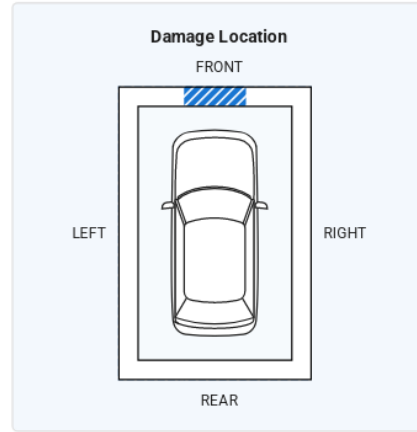

07/01/2023

45,127



Audi North Miami  
Miami, FL  
305-952-5900  
audinorthmiami.com

★ 4.6 / 5.0  
[351 Verified Reviews](#)  
♥ 226 Customer Favorites

**Vehicle serviced**

- Maintenance inspection completed
- 40,000 mile service performed
- Antifreeze/coolant checked
- Brakes checked
- Brake fluid flushed/changed
- Cabin air filter replaced/cleaned
- Drivability/performance checked
- Exterior lights checked
- Fluids checked
- Headlights adjusted
- Horns checked
- Lights checked
- Oil and filter changed
- Safety restraint system checked
- Steering/suspension checked
- Sunroof checked
- Tire condition and pressure checked
- Tire pressure monitoring system reset
- Windshield washer checked
- Wipers/washers checked

08/28/2023

Florida  
Motor Vehicle Dept.  
Hollywood, FL  
Title #0136515898

**Registration issued or renewed**

- Titled or registered as personal vehicle
- Loan or lien reported
- Vehicle color noted as Black

11/30/2023

47,855



Audi North Miami  
Miami, FL  
305-952-5900  
audinorthmiami.com

★ 4.6 / 5.0  
[351 Verified Reviews](#)  
♥ 226 Customer Favorites

**Vehicle serviced**

- Maintenance inspection completed
- Fuel injector(s) replaced
- Intake manifold gasket(s) replaced

05/20/2024



Damage Report



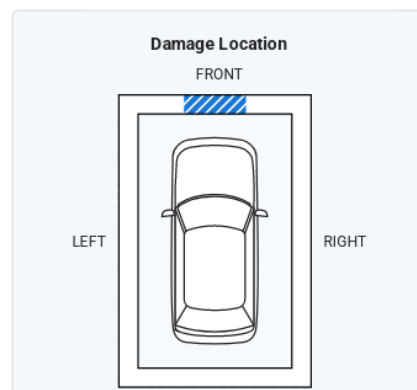

**Accident reported**

- Vehicle involved in a rear-end collision with another motor vehicle
- Damage to front
- Airbags did not deploy

**CARFAX HAS THE MOST ACCIDENT & DAMAGE INFORMATION**



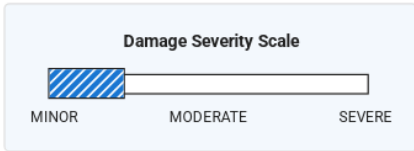
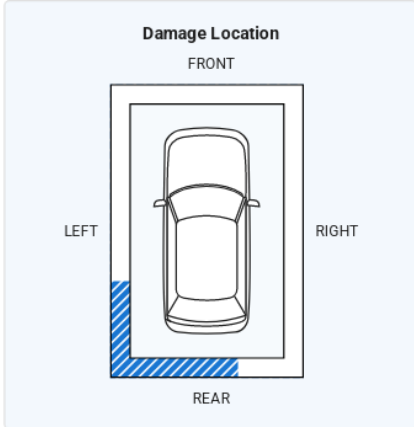

07/01/2024	Florida Motor Vehicle Dept. Hollywood, FL Title #0136515898	<b>Registration issued or renewed</b> - Titled or registered as personal vehicle - Loan or lien reported - Vehicle color noted as Black
09/05/2024 	64,080 Audi North Miami Miami, FL 305-952-5900 audinorthmiami.com ★ 4.6 / 5.0 <a href="#">351 Verified Reviews</a> ♥ 226 Customer Favorites	<b>Vehicle serviced</b> - Maintenance inspection completed - 50,000 mile service performed - Brakes checked - Oil and filter changed - Tire condition and pressure checked
08/24/2025 	Damage Report  	<b>Accident reported: minor damage with another motor vehicle</b> ⓘ - It hit a curb - Damage to left rear - Damage to rear    
09/24/2025	Florida Motor Vehicle Dept. Hollywood, FL Title #0136515898	<b>Registration issued or renewed</b> - Titled or registered as personal vehicle - Vehicle color noted as Black
11/11/2025 	Damage Report	<b>SALVAGE TITLE/CERTIFICATE ISSUED</b>

**CARFAX HAS THE MOST ACCIDENT & DAMAGE INFORMATION**

Have Questions? Consumers, please visit our Help Center at [www.carfax.com](http://www.carfax.com). Dealers or Subscribers, please visit our Help Center at [www.carfaxonline.com](http://www.carfaxonline.com).

Follow Us:  [facebook.com/CARFAX](https://facebook.com/CARFAX)  [@CARFAXinc](https://twitter.com/CARFAXinc)  [About CARFAX](#)

CARFAX DEPENDS ON ITS SOURCES FOR THE ACCURACY AND RELIABILITY OF ITS INFORMATION. THEREFORE, NO RESPONSIBILITY IS ASSUMED BY CARFAX OR ITS AGENTS FOR ERRORS OR OMISSIONS IN THIS REPORT. CARFAX FURTHER EXPRESSLY DISCLAIMS ALL WARRANTIES, EXPRESS OR IMPLIED, INCLUDING ANY IMPLIED WARRANTIES OF MERCHANTABILITY OR FITNESS FOR A PARTICULAR PURPOSE.

© 2025 CARFAX, Inc., part of S&P Global. All rights reserved.  
11/13/25 8:38:37 AM (CST)

I have reviewed and received a copy of the CARFAX Vehicle History Report for this 2019 AUDI Q3 vehicle (VIN: WA1DECF37K1086355), which is based

I have reviewed and received a copy of the CARFAX Vehicle History Report for this 2019 AUDI Q3 vehicle (VIN: WA1DECF37K1086355), which is based on information supplied to CARFAX and available as of 11/13/25 at 9:38 AM (EST).

---

Customer Signature

Date

---

Dealer Signature

Date