

2021 AUDI Q3 QUATTRO S LINE PREM PLUS 45 TFSI

VIN: WA1EECF30M1059750
4 DOOR WAGON/SPORT UTILITY
2.0L I4 F DOHC 16V
GASOLINE
ALL WHEEL DRIVE

Branded Title: Salvage >

1 Service history record >

At least 1 open recall >

2 Previous owners >

Types of owners: Personal lease, Personal >

30,345 Last reported odometer reading >

CARFAX HAS THE MOST
ACCIDENT & DAMAGE
INFORMATION



This CARFAX Vehicle History Report is based only on [information](#) supplied to CARFAX and available as of 11/4/25 at 8:22:25 AM (CST). Other information about this vehicle, including problems, may not have been reported to CARFAX. Use this report as one important tool, along with a vehicle inspection and test drive, to make a better decision about your next used car.

Accident / Damage History

Not all accidents / issues are reported to CARFAX

Event 1

01/20/2023

Accident reported: minor damage with another motor vehicle ⓘ

[View More Details >](#)

Damage Severity Scale

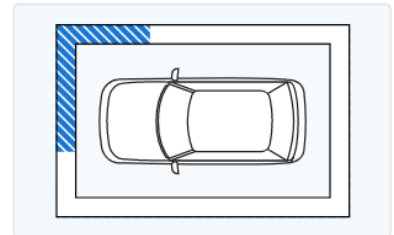
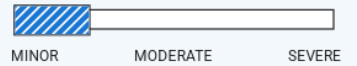

Event 2

10/07/2025

Accident reported: moderate damage ⓘ

- Airbag deployed

[View More Details >](#)

Damage Severity Scale

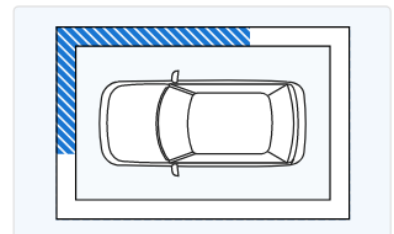

Event 3

10/30/2025

TOTAL LOSS VEHICLE[View More Details >](#)**CARFAX****Additional History**

Not all accidents / issues are reported to CARFAX

	Owner 1	Owner 2
Total Loss ⓘ Total Loss Reported: 10/30/2025.	✓	Total Loss Reported
Structural Damage ⓘ CARFAX recommends that you have this vehicle inspected by a collision repair specialist.	✓	✓
Airbag Deployment ⓘ Airbag deployment reported: 10/07/2025.	✓	Airbag Deployment
Odometer Check ⓘ No indication of an odometer rollback.	✓	✓
Accident / Damage ⓘ DMV title problems reported. Accidents reported: 01/20/2023 and 10/07/2025.	Accident Reported	Severe Damage
Manufacturer Recall ⓘ At least 1 manufacturer recall requires service. Locate an authorized Audi dealer to obtain more information about this recall.	Recall Reported	No New Recalls Reported
Basic Warranty ⓘ Original manufacturer warranty likely voided by manufacturer.	✓	Warranty Voided

CARFAX**Title History**

	Owner 1	Owner 2
Damage Brands ⓘ Salvage Junk Rebuilt Fire Flood Hail Lemon	No Problem	Alert! Problem Found
Odometer Brands ⓘ Not Actual Mileage Exceeds Mechanical Limits	No Problem	No Problem

**ALERT!** - Severe problems were reported by a state Department of Motor Vehicles (DMV). This vehicle does not qualify for the CARFAX Buyback Guarantee.**CARFAX****Ownership History**

The number of owners is estimated

	Owner 1	Owner 2
Year purchased	2021	2024
Type of owner	Personal lease	Personal
Estimated length of ownership	3 yrs. 6 mo.	11 months
Owned in the following states/provinces	New York	New York
Estimated miles driven per year	8,132/yr	--

Estimated miles driven per year

28,632

30,345

CARFAX Detailed History

[Glossary](#)

 **Owner 1**
Purchased: 2021

Personal Lease Vehicle
8,132 mi/yr

Date	Mileage	Source	Comments
03/26/2021		NICB	Vehicle manufactured and shipped to original dealer
03/26/2021		Audi Great Neck Great Neck, NY 516-829-2834 audigreatneck.com/ ★ 4.4 / 5.0 490 Verified Reviews ✓ ❤️ 10,724 Customer Favorites	Vehicle sold
03/26/2021	10	Audi Great Neck Great Neck, NY 516-829-2834 audigreatneck.com/ ★ 4.4 / 5.0 490 Verified Reviews ✓ ❤️ 10,724 Customer Favorites	Vehicle serviced - Pre-delivery inspection completed - Emissions or safety inspection performed
03/26/2021		New York Motor Vehicle Dept. Huntington, NY	Registration issued or renewed - Titled or registered as personal lease vehicle - Passed safety inspection
04/26/2021		New York Motor Vehicle Dept. Libertyville, IL	Title issued or updated - First owner reported
08/13/2021		Audi	Manufacturer Compliance Recall issued - NHTSA #21V606 - Recall #69CS AUTOMATIC LOCKING RETRACTOR (ALR) SEAT BELT RETRACTORS - Status: Remedy Available Locate an authorized Audi dealer to obtain more information about this recall ⊕ Learn more about this recall
03/07/2022	12,301	New York Inspection Station	Passed safety inspection - Emissions inspection performed
01/20/2023		Damage Report	Accident reported: minor damage with another motor vehicle ⓘ - Damage to right front - Damage to front

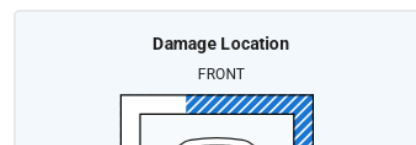
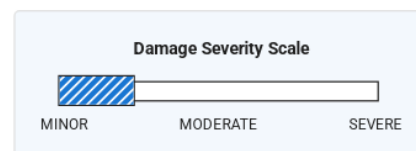

CARFAX HAS THE MOST ACCIDENT & DAMAGE

CARFAX HAS THE MOST ACCIDENT & DAMAGE INFORMATION

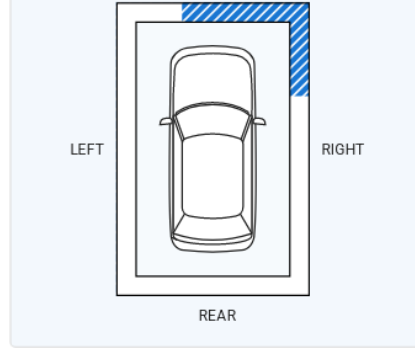

02/10/2023		New York Motor Vehicle Dept. Huntington, NY	Registration issued or renewed - Passed safety inspection
03/16/2023	21,026	New York Inspection Station	Passed safety inspection - Passed emissions inspection
03/15/2024	26,002	New York Inspection Station	Passed safety inspection - Passed emissions inspection
10/01/2024	28,632	Audi Great Neck Great Neck, NY 516-829-2834 audigreatneck.com/ ★ 4.4 / 5.0 490 Verified Reviews ✓ ♥ 10,724 Customer Favorites	Vehicle sold
10/04/2024		Audi Great Neck Great Neck, NY 516-829-2834 audigreatneck.com/ ★ 4.4 / 5.0 490 Verified Reviews ✓ ♥ 10,724 Customer Favorites	Vehicle offered for sale

Owner 2 Personal Vehicle
Purchased: 2024

Date	Mileage	Source	Comments
11/01/2024		New York Motor Vehicle Dept. Huntington, NY	Title issued or updated - New owner reported
12/31/2024		New York Motor Vehicle Dept. Huntington, NY	Registration issued or renewed - Titled or registered as personal vehicle - Passed safety inspection
03/03/2025	30,345	New York Inspection Station	Passed safety inspection - Passed emissions inspection

10/07/2025 **Damage Report**

Accident reported: moderate damage

- Damage to front
- Damage to right side
- Damage to right front
- Airbag deployed

[CARFAX Airbag Tips](#)

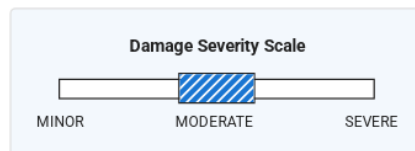

CARFAX HAS THE MOST ACCIDENT & DAMAGE INFORMATION



10/30/2025	Damage Report	TOTAL LOSS VEHICLE
		<p>There are many reasons an insurance company will declare a vehicle a total loss. Have this vehicle inspected by a qualified technician before you buy. Learn More</p>
10/30/2025		New York Motor Vehicle Dept.
10/30/2025	New York Motor Vehicle Dept. Albany, NY	SALVAGE TITLE/CERTIFICATE ISSUED
10/31/2025	Damage Report	SALVAGE TITLE/CERTIFICATE ISSUED
11/04/2025	Audi	<p>Connect Service available with subscription</p> <p>Connect offers services to enhance navigation, infotainment, and peace of mind</p> <p>Learn more</p>

Have Questions? Consumers, please visit our Help Center at www.carfax.com. Dealers or Subscribers, please visit our Help Center at www.carfaxonline.com.

Follow Us: facebook.com/CARFAX [@CARFAXinc](https://twitter.com/CARFAXinc) [About CARFAX](#)

CARFAX DEPENDS ON ITS SOURCES FOR THE ACCURACY AND RELIABILITY OF ITS INFORMATION. THEREFORE, NO RESPONSIBILITY IS ASSUMED BY CARFAX OR ITS AGENTS FOR ERRORS OR OMISSIONS IN THIS REPORT. CARFAX FURTHER EXPRESSLY DISCLAIMS ALL WARRANTIES, EXPRESS OR IMPLIED, INCLUDING ANY IMPLIED WARRANTIES OF MERCHANTABILITY OR FITNESS FOR A PARTICULAR PURPOSE.

© 2025 CARFAX, Inc., part of S&P Global. All rights reserved.
11/4/25 8:22:25 AM (CST)

I have reviewed and received a copy of the CARFAX Vehicle History Report for this 2021 AUDI Q3 vehicle (VIN: WA1EECF30M1059750), which is based on information supplied to CARFAX and available as of 11/4/25 at 9:22 AM (EST).

Customer Signature _____ Date _____ Dealer Signature _____ Date _____