

CARFAX History-Based Value Report

\$21,010

CARFAX Retail Value

History events affecting this vehicle's value

- Regular Oil Changes
- Personal Vehicle
- Salvage Brand

CARFAX Vehicle History Report™

US \$44.99

2021 AUDI Q3 QUATTRO S LINE PREM PLUS 45 TFSI

VIN: WA1EECF30M1100636
4 DOOR WAGON/SPORT UTILITY
2.0L I4 F DOHC 16V
GASOLINE
ALL WHEEL DRIVE

- Branded Title: Salvage >
- Regular oil changes >
- 3 Previous owners >
- Types of owners: Personal lease, Personal >
- Last owned in Hawaii >
- 15,560 Last reported odometer reading >

This CARFAX Vehicle History Report is based only on [information](#) supplied to CARFAX and available as of 1/14/26 at 2:02:52 AM (CST). Other information about this vehicle, including problems, may not have been reported to CARFAX. Use this report as one important tool, along with a vehicle inspection and test drive, to make a better decision about your next used car.

CARFAX Accident / Damage History

Not all accidents / issues are reported to CARFAX

Event 1

07/29/2025

TOTAL LOSS VEHICLE

- Accident reported
- Vehicle declared a total loss by an insurance company

[View More Details >](#)

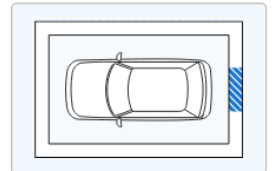

Event 2

09/23/2025

Damage reported: minor to moderate damage ⓘ

[View More Details >](#)

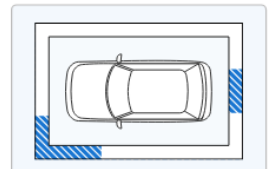
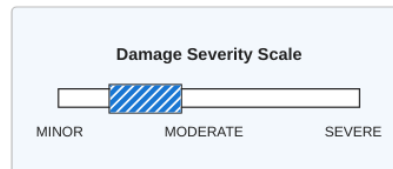

CARFAX Recent Service Highlights

Key services performed in the last 12 months

CARFAX Recent Service Highlights

Key services performed in the last 12 months

| Service | Comments | Date | |
|---|--------------------------|------------|-----------------------------------|
| Oil | ✓ Oil and filter changed | 04/24/2025 | View Details > |
|  <div style="border: 1px solid #ccc; padding: 5px; display: inline-block;"> This car has been recently serviced. That's a good thing! </div> | | | |

| CARFAX Additional History Not all accidents / issues are reported to CARFAX | Owner 1 | Owner 2 | Owner 3 |
|--|-----------------------|-----------------------|-------------------------------------|
| Total Loss ⓘ Total Loss Reported: 07/29/2025. | ✓ No Issues Reported | ✓ No Issues Reported | Total Loss Reported |
| Structural Damage ⓘ CARFAX recommends that you have this vehicle inspected by a collision repair specialist. | ✓ No Issues Reported | ✓ No Issues Reported | ✓ No Issues Reported |
| Airbag Deployment ⓘ No airbag deployment reported to CARFAX. | ✓ No Issues Reported | ✓ No Issues Reported | ✓ No Issues Reported |
| Odometer Check ⓘ No indication of an odometer rollback. | ✓ No Issues Indicated | ✓ No Issues Indicated | ✓ No Issues Indicated |
| Accident / Damage ⓘ DMV title problems reported. Accident reported: 07/29/2025. Damage reported: 09/23/2025. | ✓ No Issues Reported | ✓ No Issues Reported | Severe Damage |
| Manufacturer Recall ⓘ No open recalls reported to CARFAX. | ✓ No Recalls Reported | ✓ No Recalls Reported | ✓ No Recalls Reported |
| Basic Warranty ⓘ Original manufacturer warranty likely voided by manufacturer. | ✓ Warranty Active | ✓ Warranty Active | Warranty Voided |

| CARFAX Title History | Owner 1 | Owner 2 | Owner 3 |
|--|------------|------------|--------------------------------|
| Damage Brands ⓘ Salvage Junk Rebuilt Fire Flood Hail Lemon | No Problem | No Problem | Alert! Problem Found |
| Odometer Brands ⓘ Not Actual Mileage Exceeds Mechanical Limits | No Problem | No Problem | No Problem |

 **ALERT!** - Severe problems were reported by a state Department of Motor Vehicles (DMV). This vehicle does not qualify for the CARFAX Buyback Guarantee.











| CARFAX Ownership History The number of owners is estimated | Owner 1 | Owner 2 | Owner 3 |
|---|----------------|----------|----------|
| Year purchased | 2021 | 2025 | 2025 |
| Type of owner | Personal lease | Personal | Personal |
| Estimated length of ownership | 3 yrs. 8 mo. | 12 days | 8 months |
| Owned in the following states/provinces | Hawaii | Hawaii | Hawaii |
| Estimated miles driven per year | 4,183/yr | --- | --- |



| | | | |
|---------------------------------|----------|--------|--------|
| Estimated miles driven per year | 4,183/yr | --- | --- |
| Last reported odometer reading | 14,052 | 15,396 | 15,560 |

CARFAX Detailed History

[Glossary](#)

| | |
|--|---------------------------------------|
|  Owner 1 Purchased: 2021 | Personal Lease Vehicle 4,183 mi/yr |
|--|---------------------------------------|

| Date | Mileage | Source | Comments |
|------------|---------|--|---|
| 05/23/2021 | | NICB | Vehicle manufactured and shipped to original dealer |
| 05/23/2021 | | Hawaii Motor Vehicle Dept. | Vehicle purchase reported |
| 05/24/2021 | 17 | Audi Honolulu Honolulu, HI 808-585-6600 jnautomotive.com  150 Customer Favorites |  Vehicle serviced -Pre-delivery inspection completed -Brakes checked -Front license plate bracket installed/replaced -Safety inspection performed |
| 07/10/2021 | 20 | Hawaii Motor Vehicle Dept. Honolulu, HI Title #WDD89521 | Title or registration issued -First owner reported -Titled or registered as personal lease vehicle -Vehicle color noted as Gray |
| 08/10/2021 | 1,316 | Audi Honolulu Honolulu, HI 808-585-6600 jnautomotive.com  150 Customer Favorites |  Vehicle serviced -Maintenance inspection completed -Computer reprogrammed |
| 11/18/2021 | 3,183 | Audi Honolulu Honolulu, HI 808-585-6600 jnautomotive.com  150 Customer Favorites |  Vehicle serviced -Maintenance inspection completed |
| 04/05/2022 | | Hawaii Motor Vehicle Dept. Honolulu, HI Title #WDD89521 | Title or registration issued -Vehicle color noted as Gray |
| 06/22/2022 | 5,471 | Audi Honolulu Honolulu, HI 808-585-6600 jnautomotive.com  150 Customer Favorites |  Vehicle serviced -Maintenance inspection completed -10,000 mile service performed -Brakes checked -Oil and filter changed |
| 03/28/2023 | | Hawaii Motor Vehicle Dept. Honolulu, HI Title #WDD89521 | Title issued or updated -Title or registration issued -Vehicle color noted as Gray |
| 03/31/2023 | 8,777 | Audi Honolulu Honolulu, HI 808-585-6600 jnautomotive.com  150 Customer Favorites |  Vehicle serviced -Four tires balanced -Four tires replaced -Tire(s) replaced |
| 06/13/2023 | | Hawaii Motor Vehicle Dept. Honolulu, HI Title #WDD89521 | Registration issued or renewed -Vehicle color noted as Gray |
| 08/15/2023 | 10,728 | Audi Honolulu Honolulu, HI 808-585-6600 |  Vehicle serviced -Maintenance inspection completed -20,000 mile service performed |

| | | | | |
|------------|--------|---|---|---|
| 03/19/2024 | 10,710 | Hawaii Honolulu, HI 808-585-6600 jnautomotive.com ♥ 150 Customer Favorites |  | - Maintenance inspection completed - 20,000 mile service performed - Brakes checked - Brake fluid flushed/changed - Oil and filter changed - Tires rotated |
| 04/03/2024 | | Hawaii Motor Vehicle Dept. Honolulu, HI Title #WDD89521 | | Title issued or updated - Title or registration issued - Vehicle color noted as Gray |
| 07/08/2024 | 13,654 | Audi Honolulu Honolulu, HI 808-585-6600 jnautomotive.com ♥ 150 Customer Favorites |  | Vehicle serviced - One tire balanced - One tire mounted |
| 07/17/2024 | | Hawaii Motor Vehicle Dept. Honolulu, HI Title #WDD89521 | | Registration issued or renewed - Vehicle color noted as Gray |
| 09/30/2024 | 14,052 | Audi Honolulu Honolulu, HI 808-585-6600 jnautomotive.com ♥ 150 Customer Favorites |  | Vehicle serviced - Maintenance inspection completed - 30,000 mile service performed - Brakes checked - Oil and filter changed |

 **Owner 2** Personal Vehicle
Purchased: 2025

| Date | Mileage | Source | | Comments |
|------------|---------|--|---|---|
| 01/27/2025 | 14,404 | Hawaii Motor Vehicle Dept. Honolulu, HI Title #WDD89525 | | Title issued or updated - Title or registration issued - New owner reported - Vehicle color noted as Gray |
| 02/08/2025 | | Online Listing | | Vehicle offered for sale |
| 02/10/2025 | | Vehicle Manufacturer | | Vehicle sold |
| 02/10/2025 | | Kihei Auto Sales Kihei, HI 808-875-8782 usedcarskihei.com/ ♥ 3 Customer Favorites | | Vehicle offered for sale |
| 02/22/2025 | | Hawaii Motor Vehicle Dept. Honolulu, HI Title #WDD89525 | | Registration issued or renewed - Vehicle color noted as Gray |
| 04/24/2025 | 15,396 | KarMART Volkswagen of Maui Kihei, HI 808-419-7400 https://karmartmaui.com/ ♥ 1 Customer Favorite |  | Vehicle serviced - Maintenance inspection completed - Oil and filter changed |

 **Owner 3** Personal Vehicle
Purchased: 2025

| Date | Mileage | Source | | Comments |
|------------|---------|--|---|--|
| 04/24/2025 | | Hawaii Motor Vehicle Dept. Title #WDD89525 |  | New owner reported - SALVAGE TITLE/CERTIFICATE ISSUED |
| 05/02/2025 | | Hawaii | | Registration issued or renewed |

05/02/2025

Hawaii
Motor Vehicle Dept.
Kihei, HI
Title #WDD89525

Registration issued or renewed

- Vehicle color noted as Gray

05/08/2025

15,560

Kihei Auto Sales
Kihei, HI
808-875-8782
usedcarskihei.com/



Vehicle serviced

- Safety inspection performed

♥ 3 Customer Favorites

07/29/2025

Damage Report



TOTAL LOSS VEHICLE

- Accident reported
- Vehicle declared a total loss by an insurance company
- Damage to rear

CARFAX HAS THE MOST ACCIDENT & DAMAGE INFORMATION

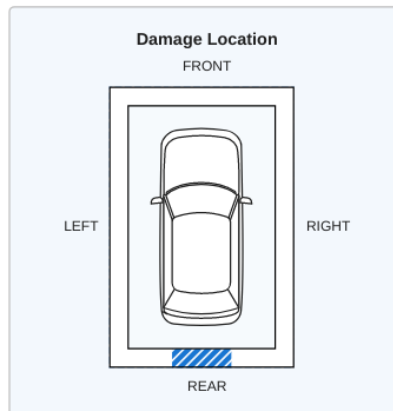

There are many reasons an insurance company will declare a vehicle a total loss. Have this vehicle inspected by a qualified technician before you buy. [Learn More](#)

09/23/2025

Damage Report



Damage reported: minor to moderate damage ⓘ

- Damage to left front
- Damage to rear

CARFAX HAS THE MOST ACCIDENT & DAMAGE INFORMATION

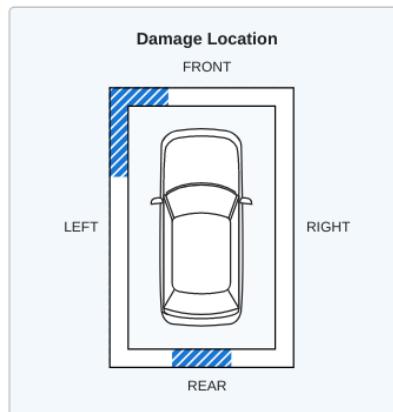
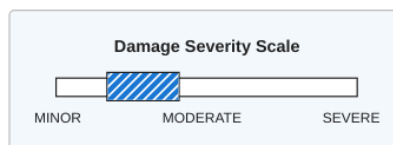

12/06/2025

Hawaii
Motor Vehicle Dept.
Kihei, HI
Title #WDD89525



SALVAGE TITLE/CERTIFICATE ISSUED

- Vehicle color noted as Gray

01/14/2026

Audi

Connect Service available with subscription

Connect offers services to enhance navigation, infotainment, and peace of mind

[Learn more](#)



This vehicle's oil change history, as reported to CARFAX, follows the manufacturer's recommendation. Track your service



This vehicle's oil change history, as reported to CARFAX, follows the manufacturer's recommendation. Track your service history for free at [carfax.com/service](https://www.carfax.com/service).

Have Questions? Consumers, please visit our Help Center at www.carfax.com. Dealers or Subscribers, please visit our Help Center at www.carfaxonline.com.

CARFAX Glossary

[Full Glossary](#)

Accident Indicator

CARFAX receives information about accidents in all 50 states, the District of Columbia and Canada.

Not every accident is reported to CARFAX. As details about the accident become available, those additional details are added to the CARFAX Vehicle History Report. CARFAX recommends that you have this vehicle inspected by a qualified mechanic.

- According to the National Safety Council, Injury Facts, 2021 edition, 5% of the 276 million registered vehicles in the U.S. were involved in an accident in 2019. Over 77% of these were considered minor or moderate.
- This CARFAX Vehicle History Report is based only on information supplied to CARFAX and available as of 1/14/26 at 2:02:52 AM (CST). Other information about this vehicle, including problems, may not have been reported to CARFAX. Use this report as one important tool, along with a vehicle inspection and test drive, to make a better decision about your next used car.

CARFAX Well Maintained - Regular Oil Changes

CARFAX identifies a "Well Maintained - Regular Oil Change" vehicle as having a regular oil change history when all its recommended oil changes, based on the vehicle's maintenance schedule, have been reported to CARFAX. CARFAX uses the manufacturer's schedule and assumes normal driving conditions. When an oil change schedule is not available, CARFAX may analyze reported service events to determine what is typical for the same make and model vehicle. Dealers and service shops may publish different recommended service schedules.

Damage Indicator

Damage can be a result of many different types of events. Examples include contact with objects (other cars, trees, traffic signs, road debris, etc), vandalism, or weather-related events. Not every damage event is reported to CARFAX. As details about the damage event become available, those additional details are added to the CARFAX Vehicle History Report. CARFAX recommends that you have this vehicle inspected by a qualified mechanic.

- This CARFAX Vehicle History Report is based only on information supplied to CARFAX and available as of 1/14/26 at 2:02:52 AM (CST). Other information about this vehicle, including problems, may not have been reported to CARFAX. Use this report as one important tool, along with a vehicle inspection and test drive, to make a better decision about your next used car.

Damage Severity

Damage events result in one of the following severity levels:

- Minor: Generally, minor damage is cosmetic (including dents or scratches), may only require reconditioning, and typically does not compromise a vehicle's operation and/or safety.
- Moderate: Moderate damage may affect multiple components of the vehicle and may impair the vehicle's operation and/or safety.
- Severe: Severe damage usually affects multiple components of the vehicle and is likely to compromise the vehicle's operation and/or safety.

CARFAX recommends getting a pre-purchase inspection at a certified collision repair facility.

First Owner

When the first owner(s) obtains a title from a Department of Motor Vehicles as proof of ownership.

New Owner Reported

When a vehicle is sold to a new owner, the Title must be transferred to the new owner(s) at a Department of Motor Vehicles.

Ownership History

CARFAX defines an owner as an individual or business that possesses and uses a vehicle. Not all title transactions represent changes in ownership. To provide estimated number of owners, CARFAX proprietary technology analyzes all the events in a vehicle history. Estimated ownership is available for vehicles manufactured after 1991 and titled solely in the US including Puerto Rico. Dealers sometimes opt to take ownership of a vehicle and are required to in the following states: Maine, Massachusetts, New Jersey, Ohio, Oklahoma, Pennsylvania and South Dakota. Please consider this as you review a vehicle's estimated ownership history.

Salvage Title

A Salvage Title is issued on a vehicle damaged to the extent that the cost of repairing the vehicle exceeds approximately 75% of its pre-damage value. This damage threshold may vary by state. Some states treat Junk titles the same as Salvage but the majority use this title to indicate that a vehicle is not road worthy and cannot be titled again in that state. The following eleven states also use Salvage titles to identify stolen vehicles - AZ, FL, GA, IL, MD, MN, NJ, NM, NY, OK and OR.

Title Issued

A state issues a title to provide a vehicle owner with proof of ownership. Each title has a unique number. Each title or registration record on a CARFAX report does not necessarily indicate a change in ownership. In Canada, a registration and bill of sale are used as proof of ownership.

Total Loss Vehicle

An insurance or fleet company declares a vehicle a total loss when a claim exceeds approximately 75% of its pre-damage value or if the vehicle is stolen and not recovered. This damage threshold varies by company. These companies typically take possession and obtain the title. Not all total loss vehicles result in a DMV-reported branded title. This may occur when an insurance company's definition of a total loss is different than the state DMV's definition for a branded title or when the owner of the vehicle is a self-insured company, like a fleet or rental company.

owner of the vehicle is a self-insured company, like a fleet or rental company.

Follow
Us:



facebook.com/CARFAX



[@CARFAXinc](https://twitter.com/CARFAXinc)



[About CARFAX](#)

CARFAX DEPENDS ON ITS SOURCES FOR THE ACCURACY AND RELIABILITY OF ITS INFORMATION. THEREFORE, NO RESPONSIBILITY IS ASSUMED BY CARFAX OR ITS AGENTS FOR ERRORS OR OMISSIONS IN THIS REPORT. CARFAX FURTHER EXPRESSLY DISCLAIMS ALL WARRANTIES, EXPRESS OR IMPLIED, INCLUDING ANY IMPLIED WARRANTIES OF MERCHANTABILITY OR FITNESS FOR A PARTICULAR PURPOSE.

© 2026 CARFAX, Inc., part of S&P Global. All rights reserved.
1/14/26 2:02:52 AM (CST)

I have reviewed and received a copy of the CARFAX Vehicle History Report for this 2021 AUDI Q3 vehicle (VIN: WA1EECF30M1100636), which is based on information supplied to CARFAX and available as of 1/14/26 at 3:02 AM (EST).

Customer Signature

Date

Dealer Signature

Date