

CARFAX History-Based Value Report

[Hide](#)

\$10,270

CARFAX Retail Value

Retail Wholesale

History events affecting this vehicle's value

- 1-Owner Vehicle
- Service History
- Personal Vehicle
- Salvage Brand

CARFAX Vehicle History Report™

US \$44.99

2015 AUDI Q3 2.0T QUATTRO PREMIUM PLUS

VIN: WA1EFCFS4FR002587
 4 DOOR WAGON/SPORT UTILITY
 2.0L I4 F DOHC 16V
 FLEX FUEL
 ALL WHEEL DRIVE

Branded Title: Salvage >

14 Service history records >

CARFAX 1-Owner vehicle >

Personal vehicle >

Last owned in Washington >

73,029 Last reported odometer reading >

CARFAX HAS THE MOST ACCIDENT & DAMAGE INFORMATION



This CARFAX Vehicle History Report is based only on [information](#) supplied to CARFAX and available as of 12/17/25 at 11:38:52 PM (CST). Other information about this vehicle, including problems, may not have been reported to CARFAX. Use this report as one important tool, along with a vehicle inspection and test drive, to make a better decision about your next used car.

CARFAX Accident / Damage History

Not all accidents / issues are reported to CARFAX

Event 1

08/01/2022

Damage reported: minor damage

[View More Details >](#)

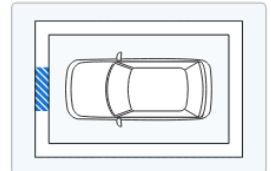
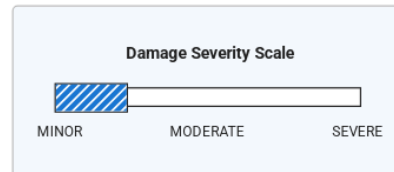

Event 2

02/13/2025

Accident reported: minor damage

[View More Details >](#)

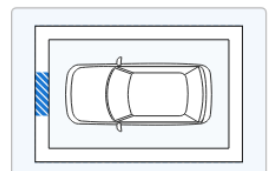
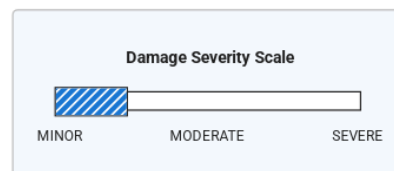



Additional History

Not all accidents / issues are reported to CARFAX

Owner 1

Total Loss i

No total loss reported to CARFAX.

✔ No Issues Reported

Structural Damage i

CARFAX recommends that you have this vehicle inspected by a collision repair specialist.

✔ No Issues Reported

Airbag Deployment i

No airbag deployment reported to CARFAX.

✔ No Issues Reported

Odometer Check i

No indication of an odometer rollback.

✔ No Issues Indicated

Accident / Damage i

DMV title problems reported. Damage reported: 08/01/2022. Accident reported: 02/13/2025.

[Severe Damage](#)

Manufacturer Recall i

No open recalls reported to CARFAX.

✔ No Recalls Reported

Basic Warranty i

Original manufacturer warranty likely voided by manufacturer.

Warranty Voided



Title History

Owner 1

Damage Brands i

Salvage | Junk | Rebuilt | Fire | Flood | Hail | Lemon

Alert!
Problem Found

Odometer Brands i

Not Actual Mileage | Exceeds Mechanical Limits

No Problem



ALERT! - Severe problems were reported by a state Department of Motor Vehicles (DMV). This vehicle does not qualify for the CARFAX Buyback Guarantee.



Ownership History

The number of owners is estimated

Owner 1

Year purchased

2014

Type of owner

Personal

Estimated length of ownership

11 yrs. 2 mo.

Owned in the following states/provinces

Washington

Estimated miles driven per year

7,672/yr

Last reported odometer reading

73,029



Detailed History

[Glossary](#)

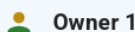

Owner 1

Purchased: 2014

Personal Vehicle





7,672 mi/yr

Date







Mileage

Source

Comments

Date	Mileage	Source	Comments
Not Reported		NICB	Vehicle manufactured and shipped to original dealer
09/24/2014	102	Audi Bellevue Bellevue, WA 425-249-7388 audibellevue.com/index.htm ★ 4.4 / 5.0 440 Verified Reviews ✓ ♥ 340 Customer Favorites	 Vehicle serviced - Pre-delivery inspection completed
09/30/2014	119	Audi Bellevue Bellevue, WA 425-249-7388 audibellevue.com/index.htm ★ 4.4 / 5.0 440 Verified Reviews ✓ ♥ 340 Customer Favorites	Vehicle sold
10/15/2014		Washington Motor Vehicle Dept. Seattle, WA	Title issued or updated - First owner reported - Titled or registered as personal vehicle
10/25/2014	493	Audi Bellevue Bellevue, WA 425-249-7388 audibellevue.com/index.htm ★ 4.4 / 5.0 440 Verified Reviews ✓ ♥ 340 Customer Favorites	 Vehicle serviced - Exterior trim checked
10/28/2014		Washington Motor Vehicle Dept. Seattle, WA Title #1428802633	Title issued or updated
06/06/2015	5,209	Audi Bellevue Bellevue, WA 425-249-7388 audibellevue.com/index.htm ★ 4.4 / 5.0 440 Verified Reviews ✓ ♥ 340 Customer Favorites	 Vehicle serviced - 5,000 mile service performed - Battery/charging system checked - Brakes checked - Tire condition and pressure checked
08/21/2015	6,688	Audi Bellevue Bellevue, WA 425-249-7388 audibellevue.com/index.htm ★ 4.4 / 5.0 440 Verified Reviews ✓ ♥ 340 Customer Favorites	 Vehicle serviced - Antenna replaced - Battery/charging system checked - Brakes checked - Tire condition and pressure checked
11/05/2015		Washington Motor Vehicle Dept. Seattle, WA Title #1428802633	Registration issued or renewed - Registration updated when owner moved the vehicle to a new location
09/20/2016		Washington Motor Vehicle Dept. Seattle, WA Title #1428802633	Registration issued or renewed
10/20/2016	14,667	Audi Bellevue Bellevue, WA 425-249-7388 audibellevue.com/index.htm ★ 4.4 / 5.0 440 Verified Reviews ✓ ♥ 340 Customer Favorites	 Vehicle serviced - 15,000 mile service performed - Battery/charging system checked - Brakes checked - Safety inspection performed - Sunroof serviced - Tire condition and pressure checked
09/25/2017		Washington Motor Vehicle Dept. Seattle, WA Title #1428802633	Registration issued or renewed

Seattle, WA
Title #1428802633

11/10/2017	22,213	University Volkswagen Audi Seattle, WA 206-634-3322 uvwaudi.com ★ 4.7 / 5.0 1,373 Verified Reviews ✓ ♥ 18,896 Customer Favorites		Vehicle serviced - 25,000 mile service performed - Brake fluid flushed/changed
03/06/2018	26,315	University Volkswagen Audi Seattle, WA 206-634-3322 uvwaudi.com ★ 4.7 / 5.0 1,373 Verified Reviews ✓ ♥ 18,896 Customer Favorites		Vehicle serviced - Maintenance inspection completed - Battery replaced
09/24/2018		Washington Motor Vehicle Dept. Seattle, WA Title #1428802633		Registration issued or renewed
11/16/2018	32,033	University Volkswagen Audi Seattle, WA 206-634-3322 uvwaudi.com ★ 4.7 / 5.0 1,373 Verified Reviews ✓ ♥ 18,896 Customer Favorites		Vehicle serviced - Maintenance inspection completed - 35,000 mile service performed - Spark plug(s) replaced - Sunroof serviced
09/21/2019		Washington Motor Vehicle Dept. Seattle, WA Title #1428802633		Registration issued or renewed
12/17/2019	43,371	University Volkswagen Audi Seattle, WA 206-634-3322 uvwaudi.com ★ 4.7 / 5.0 1,373 Verified Reviews ✓ ♥ 18,896 Customer Favorites		Vehicle serviced - Maintenance inspection completed - 45,000 mile service performed - Tires rotated
09/10/2020		Washington Motor Vehicle Dept. Seattle, WA Title #1428802633		Registration issued or renewed
12/15/2020	50,877	Johnson's Auto Repair Seattle, WA 206-522-3305 johnsonsaautorepair.net/ ★ 5.0 / 5.0 89 Verified Reviews ✓ ♥ 19 Customer Favorites		Vehicle serviced - Air filter replaced - Body lubricated - Fluids checked - Oil and filter changed
09/25/2021		Washington Motor Vehicle Dept. Seattle, WA Title #1428802633		Registration issued or renewed
02/28/2022	59,751	Johnson's Auto Repair Seattle, WA 206-522-3305 johnsonsaautorepair.net/ ★ 5.0 / 5.0 89 Verified Reviews ✓ ♥ 19 Customer Favorites		Vehicle serviced - Air filter checked - Air filter replaced - Brakes checked - Cabin air filter replaced/cleaned - Fluids checked - Oil and filter changed - Tire condition and pressure checked
08/01/2022		Damage Report		Damage reported: minor damage ⓘ - Damage to front

- Damage to front

CARFAX HAS THE MOST ACCIDENT & DAMAGE INFORMATION

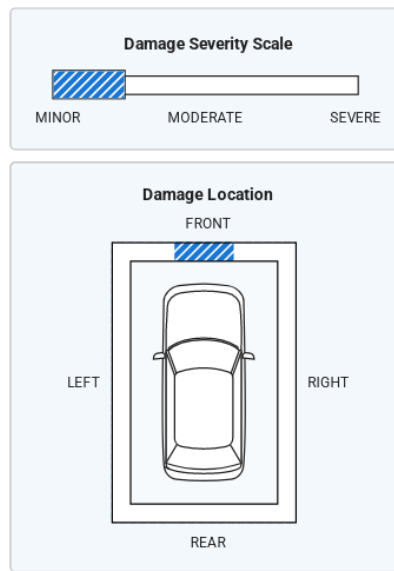

08/26/2022

63,006

Johnson's Auto Repair
Seattle, WA
206-522-3305
johnsonsaautorepair.net/

★ 5.0 / 5.0 [89 Verified Reviews](#) ✓

♥ 19 Customer Favorites



Vehicle serviced

- Battery replaced
- Body lubricated
- Fluids checked
- Oil and filter changed

09/21/2022

Washington
Motor Vehicle Dept.
Seattle, WA
Title #1428802633

Registration issued or renewed

03/10/2023

68,421

Johnson's Auto Repair
Seattle, WA
206-522-3305
johnsonsaautorepair.net/

★ 5.0 / 5.0 [89 Verified Reviews](#) ✓

♥ 19 Customer Favorites



Vehicle serviced

- Air filter checked
- Brakes checked
- Fluids checked
- Oil and filter changed
- Tire condition and pressure checked

09/26/2023

Washington
Motor Vehicle Dept.
Seattle, WA
Title #1428802633

Registration issued or renewed

04/19/2024

73,029

Johnson's Auto Repair
Seattle, WA
206-522-3305
johnsonsaautorepair.net/

★ 5.0 / 5.0 [89 Verified Reviews](#) ✓

♥ 19 Customer Favorites



Vehicle serviced

- Brake pads replaced
- Front brake pads replaced
- Front brake rotor(s) resurfaced

09/13/2024

Washington
Motor Vehicle Dept.
Seattle, WA
Title #1428802633

Registration issued or renewed

02/13/2025

Damage Report



Accident reported: minor damage ⓘ

- Damage to front

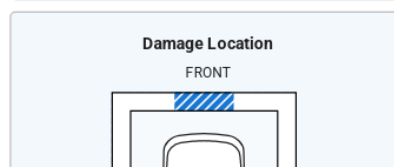
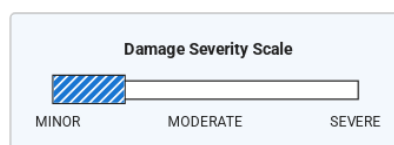

CARFAX HAS THE MOST ACCIDENT & DAMAGE INFORMATION



ACCIDENT & DAMAGE INFORMATION

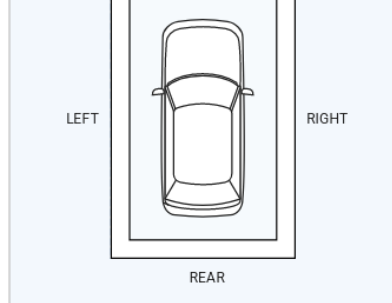

03/13/2025

Washington
Motor Vehicle Dept.
Seattle, WA
Title #1428802633



SALVAGE TITLE/CERTIFICATE ISSUED

Have Questions? Consumers, please visit our Help Center at www.carfax.com. Dealers or Subscribers, please visit our Help Center at www.carfaxonline.com.

CARFAX Glossary

[Full Glossary](#)

Accident Indicator

CARFAX receives information about accidents in all 50 states, the District of Columbia and Canada.

Not every accident is reported to CARFAX. As details about the accident become available, those additional details are added to the CARFAX Vehicle History Report. CARFAX recommends that you have this vehicle inspected by a qualified mechanic.

- According to the National Safety Council, Injury Facts, 2021 edition, 5% of the 276 million registered vehicles in the U.S. were involved in an accident in 2019. Over 77% of these were considered minor or moderate.
- This CARFAX Vehicle History Report is based only on information supplied to CARFAX and available as of 12/17/25 at 11:38:52 PM (CST). Other information about this vehicle, including problems, may not have been reported to CARFAX. Use this report as one important tool, along with a vehicle inspection and test drive, to make a better decision about your next used car.

Damage Indicator

Damage can be a result of many different types of events. Examples include contact with objects (other cars, trees, traffic signs, road debris, etc), vandalism, or weather-related events. Not every damage event is reported to CARFAX. As details about the damage event become available, those additional details are added to the CARFAX Vehicle History Report. CARFAX recommends that you have this vehicle inspected by a qualified mechanic.

- This CARFAX Vehicle History Report is based only on information supplied to CARFAX and available as of 12/17/25 at 11:38:52 PM (CST). Other information about this vehicle, including problems, may not have been reported to CARFAX. Use this report as one important tool, along with a vehicle inspection and test drive, to make a better decision about your next used car.

Damage Severity

Damage events result in one of the following severity levels:

- Minor: Generally, minor damage is cosmetic (including dents or scratches), may only require reconditioning, and typically does not compromise a vehicle's operation and/or safety.
- Moderate: Moderate damage may affect multiple components of the vehicle and may impair the vehicle's operation and/or safety.
- Severe: Severe damage usually affects multiple components of the vehicle and is likely to compromise the vehicle's operation and/or safety.

CARFAX recommends getting a pre-purchase inspection at a certified collision repair facility.

First Owner

When the first owner(s) obtains a title from a Department of Motor Vehicles as proof of ownership.

Ownership History

CARFAX defines an owner as an individual or business that possesses and uses a vehicle. Not all title transactions represent changes in ownership. To provide estimated number of owners, CARFAX proprietary technology analyzes all the events in a vehicle history. Estimated ownership is available for vehicles manufactured after 1991 and titled solely in the US including Puerto Rico. Dealers sometimes opt to take ownership of a vehicle and are required to in the following states: Maine, Massachusetts, New Jersey, Ohio, Oklahoma, Pennsylvania and South Dakota. Please consider this as you review a vehicle's estimated ownership history.

Salvage Title

A Salvage Title is issued on a vehicle damaged to the extent that the cost of repairing the vehicle exceeds approximately 75% of its pre-damage value. This damage threshold may vary by state. Some states treat Junk titles the same as Salvage but the majority use this title to indicate that a vehicle is not road worthy and cannot be titled again in that state. The following eleven states also use Salvage titles to identify stolen vehicles - AZ, FL, GA, IL, MD, MN, NJ, NM, NY, OK and OR.

Title Issued

A state issues a title to provide a vehicle owner with proof of ownership. Each title has a unique number. Each title or registration record on a CARFAX report does not necessarily indicate a change in ownership. In Canada, a registration and bill of sale are used as proof of ownership.

CARFAX DEPENDS ON ITS SOURCES FOR THE ACCURACY AND RELIABILITY OF ITS INFORMATION. THEREFORE, NO RESPONSIBILITY IS ASSUMED BY CARFAX OR ITS AGENTS FOR ERRORS OR OMISSIONS IN THIS REPORT. CARFAX FURTHER EXPRESSLY DISCLAIMS ALL WARRANTIES, EXPRESS OR IMPLIED, INCLUDING ANY IMPLIED WARRANTIES OF MERCHANTABILITY OR FITNESS FOR A PARTICULAR PURPOSE.

© 2025 CARFAX, Inc., part of S&P Global. All rights reserved.
12/17/25 11:38:52 PM (CST)

I have reviewed and received a copy of the CARFAX Vehicle History Report for this 2015 AUDI Q3 vehicle (VIN: WA1EFCFS4FR002587), which is based on information supplied to CARFAX and available as of 12/18/25 at 12:38 AM (EST).

Customer Signature

Date

Dealer Signature

Date