

## 2024 AUDI Q5 E QUATTRO S LINE PREMIUM 55 TFSI

VIN: WA1G2AFY6R2076281  
 4 DOOR WAGON/SPORT UTILITY  
 2.0L I4 F DOHC 16V  
 HYBRID  
 ALL WHEEL DRIVE

Accident reported: total loss vehicle >

3 Service history records >

At least 1 open recall >

CARFAX 1-Owner vehicle >

Personal lease vehicle >

9,061 Last reported odometer reading >

CARFAX HAS THE MOST ACCIDENT & DAMAGE INFORMATION



This CARFAX Vehicle History Report is based only on [information](#) supplied to CARFAX and available as of 11/14/25 at 8:32:34 AM (CST). Other information about this vehicle, including problems, may not have been reported to CARFAX. Use this report as one important tool, along with a vehicle inspection and test drive, to make a better decision about your next used car.

## Accident / Damage History

Not all accidents / issues are reported to CARFAX

### Event 1

09/10/2025

**Accident reported: minor to moderate damage**

- Damage to undercarriage
- Vehicle towed

[View More Details >](#)

#### Damage Severity Scale

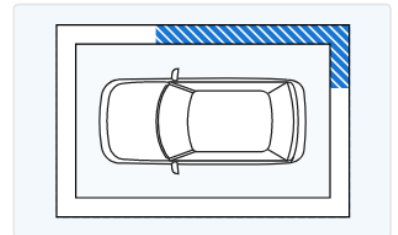
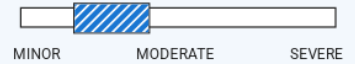

### Event 2

09/10/2025

**TOTAL LOSS VEHICLE**

- Vehicle declared a total loss by an insurance company
- Collision damage reported
- Vehicle towed

[View More Details >](#)

## Additional History

Not all accidents / issues are reported to CARFAX



Owner 1



**Total Loss**

Total Loss Reported: 09/10/2025.

[Total Loss Reported](#)

<b>Structural Damage</b> ⓘ CARFAX recommends that you have this vehicle inspected by a collision repair specialist.	✓
<b>Airbag Deployment</b> ⓘ No airbag deployment reported to CARFAX.	✓
<b>Odometer Check</b> ⓘ No indication of an odometer rollback.	✓
<b>Accident / Damage</b> ⓘ Accident reported: 09/10/2025.	<a href="#">Accident Reported</a>
<b>Manufacturer Recall</b> ⓘ At least 1 manufacturer recall requires service. Locate an authorized <a href="#">Audi dealer</a> to obtain more information about this recall.	<a href="#">Recall Reported</a>
<b>Basic Warranty</b> ⓘ <a href="#">Original warranty</a> estimated to have 30 months or 40,939 miles remaining. Confirm with dealer or vehicle manufacturer.	✓









 <b>Title History</b> <small>CARFAX guarantees the information in this section</small>	 Owner 1
<b>Damage Brands</b> ⓘ Salvage   Junk   Rebuilt   Fire   Flood   Hail   Lemon	✓
<b>Odometer Brands</b> ⓘ Not Actual Mileage   Exceeds Mechanical Limits	✓
 <b>GUARANTEED</b> - None of these title problems were reported by a U.S. state Department of Motor Vehicles (DMV). If you find that any of these title problems were reported by a DMV and not included in this report, you may qualify. <a href="#">View Terms</a>   <a href="#">View Certificate</a>	

 <b>Ownership History</b> <small>The number of owners is estimated</small>	 Owner 1
Year purchased	2024
Type of owner	Personal lease
Estimated length of ownership	1 yr. 6 mo.
Owned in the following states/provinces	California
Estimated miles driven per year	8,288/yr
Last reported odometer reading	9,061

 **Detailed History**
[Glossary](#)

 <b>Owner 1</b> Purchased: 2024	Personal Lease Vehicle 8,288 mi/yr
---	---------------------------------------

Date	Mileage	Source	Comments
Not Reported		NICB	<b>Vehicle manufactured and shipped to original dealer</b>

Not Reported		NICB	<b>Vehicle manufactured and shipped to original dealer</b>
04/26/2024 	13	Audi Fletcher Jones Costa Mesa, CA 949-791-1500 audifletcherjones.com  ★ 4.4 / 5.0 <a href="#">190 Verified Reviews</a>  ♥ 35 Customer Favorites	<b>Vehicle serviced</b> - Pre-delivery inspection completed - Tire condition and pressure checked - Vehicle washed/detailed
04/27/2024		Audi Fletcher Jones Costa Mesa, CA 949-791-1500 audifletcherjones.com/  ★ 4.4 / 5.0 <a href="#">190 Verified Reviews</a>  ♥ 35 Customer Favorites	<b>Vehicle offered for sale</b>
05/10/2024	17	California Motor Vehicle Dept. Laguna Beach, CA	<b>Odometer reading reported</b>
05/23/2024		California Motor Vehicle Dept. Laguna Beach, CA	<b>Title issued or updated</b> - First owner reported - Titled or registered as personal lease vehicle - Loan or lien reported
11/21/2024 	3,768	Audi Fletcher Jones Costa Mesa, CA 949-791-1500 audifletcherjones.com  ★ 4.4 / 5.0 <a href="#">190 Verified Reviews</a>  ♥ 35 Customer Favorites	<b>Vehicle serviced</b> - Maintenance inspection completed - Computer reprogrammed - Tire condition and pressure checked
12/03/2024		Audi	<b>Manufacturer Safety Recall issued</b> - NHTSA #24V898 25V080 - Recall #93AA HIGH-VOLTAGE BATTERY - Status: Remedy Available  Locate an authorized <a href="#">Audi dealer</a> to obtain more information about this recall  <a href="#">⊕ Learn more about this recall</a>
06/26/2025 	9,061	Audi Fletcher Jones Costa Mesa, CA 949-791-1500 audifletcherjones.com  ★ 4.4 / 5.0 <a href="#">190 Verified Reviews</a>  ♥ 35 Customer Favorites	<b>Vehicle serviced</b> - Fuel filler door replaced/repared - Tire condition and pressure checked
09/10/2025 		Damage Report	<b>Accident reported: minor to moderate damage</b>  - Damage to right rear - Damage to undercarriage - Damage to right side - Vehicle towed

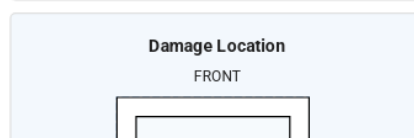
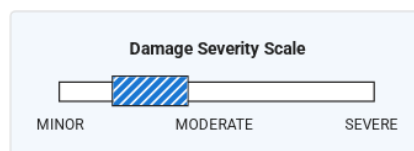

# CARFAX HAS THE MOST ACCIDENT & DAMAGE INFORMATION

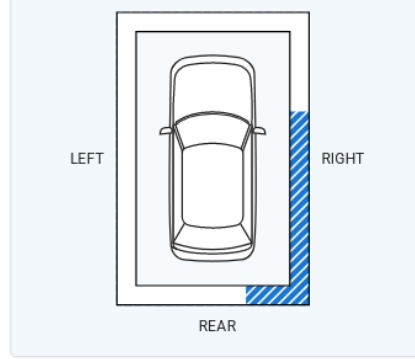

09/10/2025



Damage Report

### TOTAL LOSS VEHICLE

- Vehicle declared a total loss by an insurance company
- Collision damage reported
- Vehicle towed



There are many reasons an insurance company will declare a vehicle a total loss. Have this vehicle inspected by a qualified technician before you buy. [Learn More](#)

11/14/2025

Audi

**Connect Service available with subscription**

**Connect offers services to enhance navigation, infotainment, and peace of mind**

[Learn more](#)

Have Questions? Consumers, please visit our Help Center at [www.carfax.com](http://www.carfax.com). Dealers or Subscribers, please visit our Help Center at [www.carfaxonline.com](http://www.carfaxonline.com).

Follow Us: [facebook.com/CARFAX](https://facebook.com/CARFAX) [@CARFAXinc](https://twitter.com/CARFAXinc) [About CARFAX](#)

CARFAX DEPENDS ON ITS SOURCES FOR THE ACCURACY AND RELIABILITY OF ITS INFORMATION. THEREFORE, NO RESPONSIBILITY IS ASSUMED BY CARFAX OR ITS AGENTS FOR ERRORS OR OMISSIONS IN THIS REPORT. CARFAX FURTHER EXPRESSLY DISCLAIMS ALL WARRANTIES, EXPRESS OR IMPLIED, INCLUDING ANY IMPLIED WARRANTIES OF MERCHANTABILITY OR FITNESS FOR A PARTICULAR PURPOSE.

© 2025 CARFAX, Inc., part of S&P Global. All rights reserved.  
11/14/25 8:32:34 AM (CST)

I have reviewed and received a copy of the CARFAX Vehicle History Report for this 2024 AUDI Q5 vehicle (VIN: WA1G2AFY6R2076281), which is based on information supplied to CARFAX and available as of 11/14/25 at 9:32 AM (EST).

Customer Signature

Date

Dealer Signature

Date