

CARFAX History-Based Value Report

[Hide](#)

\$28,380

CARFAX Retail Value

Retail
 Wholesale

History events affecting this vehicle's value

- Service History
- Personal Vehicle
- Salvage Brand

CARFAX Vehicle History Report™

US \$44.99

2022 AUDI Q5 E QUATTRO S LINE PREMIUM 55 TFSI

VIN: WA1G2AFY8N2086479
 4 DOOR WAGON/SPORT UTILITY
 2.0L I4 F DOHC 16V HYBRID
 ALL WHEEL DRIVE

- Branded Title: Salvage >
- 7 Service history records >
- Great Reliability >
- 2 Previous owners >
- Personal vehicle >
- 19,910 Last reported odometer reading >

This CARFAX Vehicle History Report is based only on [information](#) supplied to CARFAX and available as of 11/6/25 at 7:59:45 AM (CST). Other information about this vehicle, including problems, may not have been reported to CARFAX. Use this report as one important tool, along with a vehicle inspection and test drive, to make a better decision about your next used car.

CARFAX Accident / Damage History

Not all accidents / issues are reported to CARFAX

Event 1

09/02/2025

Accident reported: minor to moderate damage ⓘ

- Damage to undercarriage
- Disabling damage reported
- Vehicle towed

[View More Details >](#)

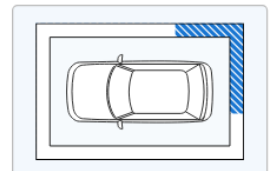
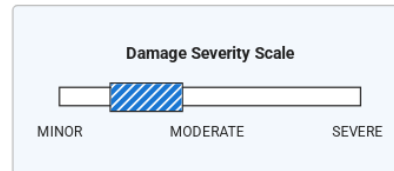

CARFAX Recent Service Highlights

Key services performed in the last 12 months

Service & Comments	Service	Comments	View Details Links
Oil	Oil and filter changed	12/27/2024	View Details >
Tires	Four tires replaced	12/27/2024	View Details >



This car has been recently serviced. That's a good thing!







CARFAX Additional History Not all accidents / issues are reported to CARFAX	Owner 1	Owner 2
Total Loss ⓘ No total loss reported to CARFAX.	✔ No Issues Reported	✔ No Issues Reported
Structural Damage ⓘ CARFAX recommends that you have this vehicle inspected by a collision repair specialist.	✔ No Issues Reported	✔ No Issues Reported
Airbag Deployment ⓘ No airbag deployment reported to CARFAX.	✔ No Issues Reported	✔ No Issues Reported
Odometer Check ⓘ No indication of an odometer rollback.	✔ No Issues Indicated	✔ No Issues Indicated
Accident / Damage ⓘ DMV title problems reported. Accident reported: 09/02/2025.	✔ No Issues Reported	Severe Damage
Manufacturer Recall ⓘ No open recalls reported to CARFAX.	✔ No Recalls Reported	✔ No Recalls Reported
Basic Warranty ⓘ Original manufacturer warranty likely voided by manufacturer.	✔ Warranty Active	Warranty Voided

CARFAX Title History	Owner 1	Owner 2
Damage Brands ⓘ Salvage Junk Rebuilt Fire Flood Hail Lemon	No Problem	Alert! Problem Found
Odometer Brands ⓘ Not Actual Mileage Exceeds Mechanical Limits	No Problem	No Problem
 ALERT! - Severe problems were reported by a state Department of Motor Vehicles (DMV). This vehicle does not qualify for the CARFAX Buyback Guarantee.		

CARFAX Ownership History The number of owners is estimated	Owner 1	Owner 2
Year purchased	2022	2025
Type of owner	Personal	Personal
Estimated length of ownership	2 yrs. 7 mo.	2 months
Owned in the following states/provinces	Florida	Florida
Estimated miles driven per year	7,579/yr	—
Last reported odometer reading	19,888	19,910

 **Owner 1**
Purchased: 2022

Personal Vehicle
7,579 mi/yr

Date	Mileage	Source	Comments
Not Reported		NICB	Vehicle manufactured and shipped to original dealer
04/21/2022	12	Audi Pembroke Pines Pembroke Pines, FL 888-378-8973 audipembrokepines.com/ ★ 4.7 / 5.0 314 Verified Reviews ✓ ❤️ 156 Customer Favorites	 Vehicle serviced - Pre-delivery inspection completed
04/27/2022	15	Florida Motor Vehicle Dept. Miami, FL Title #0146538698	Vehicle purchase reported - Title issued or updated - Registration issued or renewed - First owner reported - Titled or registered as personal vehicle - Loan or lien reported - Vehicle color noted as Gray
01/09/2023		Florida Motor Vehicle Dept. Miami, FL Title #0146538698	Registration issued or renewed - Titled or registered as personal vehicle - Loan or lien reported - Vehicle color noted as Gray
08/18/2023	10,865	The Collection Coral Gables, FL 305-444-5555 thecollection.com/ ★ 4.8 / 5.0 38 Verified Reviews ✓ ❤️ 390 Customer Favorites	 Vehicle serviced - Maintenance inspection completed - Drivability/performance checked
09/27/2023		The Collection Coral Gables, FL 305-444-5555 thecollection.com/ ★ 4.8 / 5.0 38 Verified Reviews ✓ ❤️ 390 Customer Favorites	 Vehicle serviced
01/31/2024		Florida Motor Vehicle Dept. Miami, FL Title #0146538698	Registration issued or renewed - Titled or registered as personal vehicle - Loan or lien reported - Vehicle color noted as Gray
04/25/2024	15,491	German Car Care Coral Gables, FL 305-774-1024 ★ 4.9 / 5.0 33 Verified Reviews ✓ ❤️ 6 Customer Favorites	 Vehicle serviced - Brake fluid flushed/changed - Fluids checked - Oil and filter changed
12/09/2024	19,874	Audi Pembroke Pines Pembroke Pines, FL 888-378-8973 audipembrokepines.com/ ★ 4.7 / 5.0 314 Verified Reviews ✓ ❤️ 156 Customer Favorites	 Vehicle serviced - Maintenance inspection completed
			Looks like this dealer serviced the car in order to prepare it for sale. That's a good thing!
12/11/2024		Audi Pembroke Pines Pembroke Pines, FL 888-378-8973	Vehicle offered for sale

12/11/2024

Audi Pembroke Pines
Pembroke Pines, FL
888-378-8973
audipembrokepines.com/

★ 4.7 / 5.0 [314 Verified Reviews](#) ✓

♥ 156 Customer Favorites

Vehicle offered for sale

12/27/2024

19,884

Audi Pembroke Pines
Pembroke Pines, FL
888-378-8973
audipembrokepines.com/

★ 4.7 / 5.0 [314 Verified Reviews](#) ✓

♥ 156 Customer Favorites



Vehicle serviced

- Maintenance inspection completed
- 20,000 mile service performed
- Brakes checked
- Cabin air filter replaced/cleaned
- Four tires balanced
- Four tires replaced
- Maintenance reminder reset
- Oil and filter changed
- Safety inspection performed
- Tire condition and pressure checked

01/11/2025

19,885

Audi Pembroke Pines
Pembroke Pines, FL
888-378-8973
audipembrokepines.com/

★ 4.7 / 5.0 [314 Verified Reviews](#) ✓

♥ 156 Customer Favorites

Odometer reading reported

04/24/2025

19,888

Audi Pembroke Pines
Pembroke Pines, FL
888-378-8973
audipembrokepines.com/

★ 4.7 / 5.0 [314 Verified Reviews](#) ✓

♥ 156 Customer Favorites



Vehicle serviced

- Computer reprogrammed



Looks like this dealer serviced the car in order to prepare it for sale. That's a good thing!

Owner 2

Purchased: 2025

Personal Vehicle

Date	Mileage	Source	Comments
------	---------	--------	----------

08/15/2025

19,910

Florida
Motor Vehicle Dept.
Miami, FL
Title #0146538698

Vehicle purchase reported

- Title issued or updated
- Registration issued or renewed
- New owner reported
- Titled or registered as personal vehicle
- Loan or lien reported
- Vehicle color noted as Gray



Avoid financial headaches. Make sure the loan has been paid off if you're buying from a private seller. [Learn More](#)

09/02/2025

Damage Report



Accident reported: minor to moderate damage ⓘ

- Damage to right rear
- Damage to rear
- Damage to undercarriage
- Disabling damage reported
- Vehicle towed

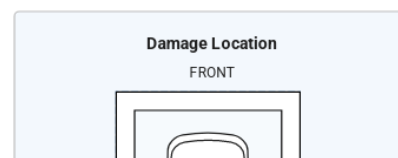
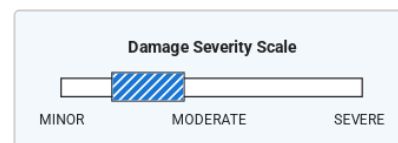

CARFAX HAS THE MOST ACCIDENT & DAMAGE INFORMATION

CARFAX HAS THE MOST ACCIDENT & DAMAGE INFORMATION

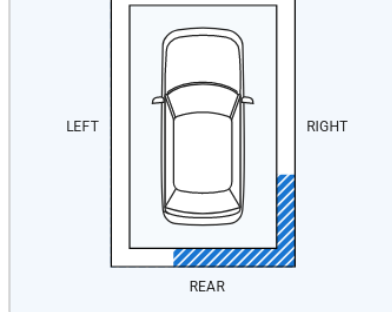

11/02/2025

Damage Report



SALVAGE TITLE/CERTIFICATE ISSUED

11/06/2025

Audi

Connect Service available with subscription

Connect offers services to enhance navigation, infotainment, and peace of mind

[Learn more](#)

Have Questions? Consumers, please visit our Help Center at www.carfax.com. Dealers or Subscribers, please visit our Help Center at www.carfaxonline.com.

Accident Indicator

CARFAX receives information about accidents in all 50 states, the District of Columbia and Canada.

Not every accident is reported to CARFAX. As details about the accident become available, those additional details are added to the CARFAX Vehicle History Report. CARFAX recommends that you have this vehicle inspected by a qualified mechanic.

- According to the National Safety Council, Injury Facts, 2021 edition, 5% of the 276 million registered vehicles in the U.S. were involved in an accident in 2019. Over 77% of these were considered minor or moderate.
- This CARFAX Vehicle History Report is based only on information supplied to CARFAX and available as of 11/6/25 at 7:59:45 AM (CST). Other information about this vehicle, including problems, may not have been reported to CARFAX. Use this report as one important tool, along with a vehicle inspection and test drive, to make a better decision about your next used car.

Damage Indicator

Damage can be a result of many different types of events. Examples include contact with objects (other cars, trees, traffic signs, road debris, etc), vandalism, or weather-related events. Not every damage event is reported to CARFAX. As details about the damage event become available, those additional details are added to the CARFAX Vehicle History Report. CARFAX recommends that you have this vehicle inspected by a qualified mechanic.

- This CARFAX Vehicle History Report is based only on information supplied to CARFAX and available as of 11/6/25 at 7:59:45 AM (CST). Other information about this vehicle, including problems, may not have been reported to CARFAX. Use this report as one important tool, along with a vehicle inspection and test drive, to make a better decision about your next used car.

Damage Severity

Damage events result in one of the following severity levels:

- Minor: Generally, minor damage is cosmetic (including dents or scratches), may only require reconditioning, and typically does not compromise a vehicle's operation and/or safety.
- Moderate: Moderate damage may affect multiple components of the vehicle and may impair the vehicle's operation and/or safety.
- Severe: Severe damage usually affects multiple components of the vehicle and is likely to compromise the vehicle's operation and/or safety.

CARFAX recommends getting a pre-purchase inspection at a certified collision repair facility.

First Owner

When the first owner(s) obtains a title from a Department of Motor Vehicles as proof of ownership.

New Owner Reported

When a vehicle is sold to a new owner, the Title must be transferred to the new owner(s) at a Department of Motor Vehicles.

Ownership History

CARFAX defines an owner as an individual or business that possesses and uses a vehicle. Not all title transactions represent changes in ownership. To provide estimated number of owners, CARFAX proprietary technology analyzes all the events in a vehicle history. Estimated ownership is available for vehicles manufactured after 1991 and titled solely in the US including Puerto Rico. Dealers sometimes opt to take ownership of a vehicle and are required to in the following states: Maine, Massachusetts, New Jersey, Ohio, Oklahoma, Pennsylvania and South Dakota. Please consider this as you review a vehicle's estimated ownership history.

Reliability Forecast

The CARFAX 3-Year Reliability Forecast predicts the likelihood of repairs for a vehicle over the next three years. This forecast is based on vehicles of the same year, make, and model with similar mileage, damage, service history, and other factors, and assumes an average of 15,000 miles driven per year. Repairs are separate from regular maintenance, such as oil changes. Some of the repairs predicted may be covered under warranty. The 3-Year Reliability Forecast is based on data reported to Carfax and is only a prediction, not a guarantee.



maintenance, such as oil changes. Some of the repairs predicted may be covered under warranty. The 3-Year Reliability Forecast is based on data reported to Carfax and is only a prediction, not a guarantee.

Salvage Title

A Salvage Title is issued on a vehicle damaged to the extent that the cost of repairing the vehicle exceeds approximately 75% of its pre-damage value. This damage threshold may vary by state. Some states treat Junk titles the same as Salvage but the majority use this title to indicate that a vehicle is not road worthy and cannot be titled again in that state. The following eleven states also use Salvage titles to identify stolen vehicles - AZ, FL, GA, IL, MD, MN, NJ, NM, NY, OK and OR.

Title Issued

A state issues a title to provide a vehicle owner with proof of ownership. Each title has a unique number. Each title or registration record on a CARFAX report does not necessarily indicate a change in ownership. In Canada, a registration and bill of sale are used as proof of ownership.

Follow Us:  facebook.com/CARFAX  [@CARFAXinc](https://twitter.com/CARFAXinc)  [About CARFAX](https://youtube.com/CARFAX)

CARFAX DEPENDS ON ITS SOURCES FOR THE ACCURACY AND RELIABILITY OF ITS INFORMATION. THEREFORE, NO RESPONSIBILITY IS ASSUMED BY CARFAX OR ITS AGENTS FOR ERRORS OR OMISSIONS IN THIS REPORT. CARFAX FURTHER EXPRESSLY DISCLAIMS ALL WARRANTIES, EXPRESS OR IMPLIED, INCLUDING ANY IMPLIED WARRANTIES OF MERCHANTABILITY OR FITNESS FOR A PARTICULAR PURPOSE.

© 2025 CARFAX, Inc., part of S&P Global. All rights reserved.
11/6/25 7:59:45 AM (CST)

I have reviewed and received a copy of the CARFAX Vehicle History Report for this 2022 AUDI Q5 vehicle (VIN: WA1G2AFY8N2086479), which is based on information supplied to CARFAX and available as of 11/6/25 at 8:59 AM (EST).

Customer Signature

Date

Dealer Signature

Date