

## CARFAX History-Based Value Report

**\$9,920**

CARFAX Retail Value

### History events affecting this vehicle's value

- Service History
- Personal Vehicle
- Total Loss
- Airbag Deployed

## CARFAX Vehicle History Report™

US \$44.99

### 2016 AUDI Q5 2.0T QUATTRO PREMIUM PLUS

VIN: WA1L2AFPXGA048086  
 4 DOOR WAGON/SPORT UTILITY  
 2.0L V4 F DOHC 16V  
 FLEX FUEL  
 ALL WHEEL DRIVE

- Total loss vehicle >
- 22 Service history records >
- 2 Previous owners >
- Personal vehicle >
- Last owned in Michigan >
- 102,775 Last reported odometer reading >

This CARFAX Vehicle History Report is based only on [information](#) supplied to CARFAX and available as of 1/21/26 at 2:26:07 PM (CST). Other information about this vehicle, including problems, may not have been reported to CARFAX. Use this report as one important tool, along with a vehicle inspection and test drive, to make a better decision about your next used car.

## CARFAX Accident / Damage History

Not all accidents / issues are reported to CARFAX

### Event 1

03/01/2016

#### Accident reported: severe damage ⓘ

- Vehicle involved in a rear-end collision with another motor vehicle
- Airbags did not deploy

[View More Details >](#)

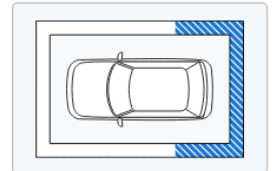
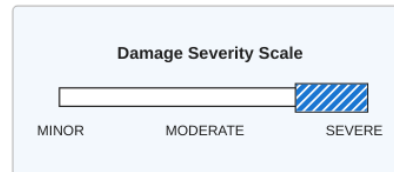

### Event 2

05/11/2019

#### Accident reported with another motor vehicle

- Airbags did not deploy

[View More Details >](#)

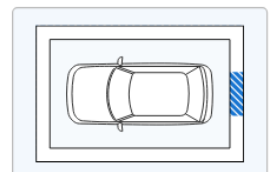

### Event 3

01/03/2020

**Accident reported**

- Involving rear impact with another motor vehicle
- Airbags did not deploy

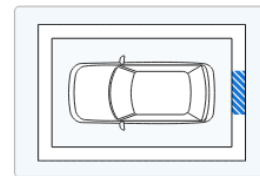
[Show More](#) ▾

<b>CARFAX</b> Additional History Not all accidents / issues are reported to CARFAX	Owner 1	Owner 2
<b>Total Loss</b> ⓘ Total Loss Reported: 01/06/2026.	✓ No Issues Reported	<a href="#">Total Loss Reported</a>
<b>Structural Damage</b> ⓘ CARFAX recommends that you have this vehicle inspected by a collision repair specialist.	✓ No Issues Reported	✓ No Issues Reported
<b>Airbag Deployment</b> ⓘ Airbag deployment reported: 09/26/2025.	✓ No Issues Reported	<a href="#">Airbag Deployment</a>
<b>Odometer Check</b> ⓘ No indication of an odometer rollback.	✓ No Issues Indicated	✓ No Issues Indicated
<b>Accident / Damage</b> ⓘ Accidents reported: 03/01/2016, 05/11/2019, 01/03/2020, and 09/26/2025. Damage reported: 06/12/2024 and 06/20/2025.	<a href="#">Severe Damage</a>	<a href="#">Accident Reported</a>
<b>Manufacturer Recall</b> ⓘ No open recalls reported to CARFAX.	✓ No Recalls Reported	✓ No Recalls Reported
<b>Basic Warranty</b> ⓘ <a href="#">Original warranty</a> estimated to have expired.	<b>Warranty Expired</b>	<b>Warranty Expired</b>

<b>CARFAX</b> Title History CARFAX guarantees the information in this section	Owner 1	Owner 2
<b>Damage Brands</b> ⓘ Salvage   Junk   Rebuilt   Fire   Flood   Hail   Lemon	✓ <b>Guaranteed</b> No Problem	✓ <b>Guaranteed</b> No Problem
<b>Odometer Brands</b> ⓘ Not Actual Mileage   Exceeds Mechanical Limits	✓ <b>Guaranteed</b> No Problem	✓ <b>Guaranteed</b> No Problem



**GUARANTEED** - None of these title problems were reported by a U.S. state Department of Motor Vehicles (DMV). If you find that any of these title problems were reported by a DMV and not included in this report, you may qualify.  
[View Terms](#) | [View Certificate](#)

<b>CARFAX</b> Ownership History The number of owners is estimated	Owner 1	Owner 2
Year purchased	2015	2024
Type of owner	Personal	Personal
Estimated length of ownership	8 yrs. 9 mo.	1 yr. 3 mo.
Owned in the following states/provinces	Illinois	Michigan
Estimated miles driven per year	9,132/yr	9,574/yr

Last reported odometer reading

80,112









102,775

**CARFAX** Detailed History

[Glossary](#)

 **Owner 1**  
Purchased: 2015

Personal Vehicle  
9,132 mi/yr

Date	Mileage	Source	Comments
Not Reported		NICB	<b>Vehicle manufactured and shipped to Illinois</b>
10/07/2015	16	Audi Westmont Westmont, IL 630-537-0310 laurelwestmontaudi.com  <b>3,896</b> Customer Favorites	<b>Vehicle offered for sale</b>
10/07/2015		Audi Westmont Westmont, IL 630-537-0310 laurelwestmontaudi.com  <b>3,896</b> Customer Favorites	 <b>Vehicle serviced</b> -Pre-delivery inspection completed -Vehicle washed/detailed
10/14/2015	30	Audi Westmont Westmont, IL 630-537-0310 laurelwestmontaudi.com  <b>3,896</b> Customer Favorites	<b>Vehicle sold</b>
10/14/2015		Illinois Motor Vehicle Dept.	<b>Vehicle purchase reported</b> -Titled or registered as personal vehicle
10/26/2015		Illinois Motor Vehicle Dept. Lisle, IL Title #152996927500	<b>Title issued or updated</b> -Registration issued or renewed -First owner reported -Vehicle color noted as Gray
02/08/2016	5,466	Audi Westmont Westmont, IL 630-537-0310 laurelwestmontaudi.com  <b>3,896</b> Customer Favorites	 <b>Vehicle serviced</b> -5,000 mile service performed -Brakes checked -Safety inspection performed -Tire condition and pressure checked
03/01/2016		Damage Report	 <b>Accident reported: severe damage</b>  -Vehicle involved in a rear-end collision with another motor vehicle -Damage to rear -Damage to left rear -Damage to right rear -Airbags did not deploy

**CARFAX HAS THE MOST ACCIDENT & DAMAGE INFORMATION**

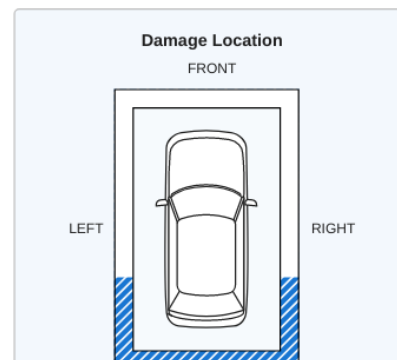
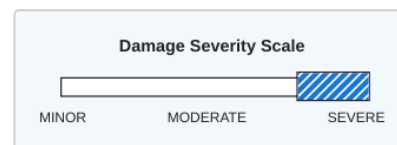



04/15/2016	6,436	Audi Westmont Westmont, IL 630-537-0310 laurelwestmontaudi.com ♥ 3,896 Customer Favorites		<b>Vehicle serviced</b> -Maintenance inspection completed -Brakes checked -Four wheel alignment performed -Tire condition and pressure checked
07/27/2016		Illinois Motor Vehicle Dept. Lisle, IL		<b>Registration issued or renewed</b>
01/07/2017	16,518	Continental Audi of Naperville Naperville, IL 630-388-1000 continentalaudi.com		<b>Vehicle serviced</b> -15,000 mile service performed -Brakes checked -Drivability/performance checked -Front brake pads replaced -Oil and filter changed -Rear brake pads replaced -Sunroof serviced -Tire condition and pressure checked -Wheels checked
02/27/2017	18,669	Audi Westmont Westmont, IL 630-537-0310 laurelwestmontaudi.com ♥ 3,896 Customer Favorites		<b>Vehicle serviced</b> -Maintenance inspection completed -Battery/charging system checked -Brakes checked -Computer reprogrammed -Drivability/performance checked -Heated oxygen sensor replaced -Tire condition and pressure checked
06/10/2017		Illinois Motor Vehicle Dept. Lisle, IL		<b>Registration issued or renewed</b>
10/20/2017	26,600	Audi Westmont Westmont, IL 630-537-0310 laurelwestmontaudi.com ♥ 3,896 Customer Favorites		<b>Vehicle serviced</b> -25,000 mile service performed -Battery/charging system checked -Brake fluid flushed/changed -Tire condition and pressure checked
06/30/2018	35,260	Continental Audi of Naperville Naperville, IL 630-388-1000 continentalaudi.com		<b>Vehicle serviced</b>
06/30/2018		Illinois Motor Vehicle Dept. Lisle, IL		<b>Registration issued or renewed</b>
08/11/2018	36,611	Audi Westmont Westmont, IL 630-537-0310 laurelwestmontaudi.com ♥ 3,896 Customer Favorites		<b>Vehicle serviced</b> -Maintenance inspection completed -35,000 mile service performed -Battery/charging system checked -Brakes checked -Spark plug(s) replaced
02/01/2019	42,860	Continental Audi of Naperville Naperville, IL 630-388-1000 continentalaudi.com		<b>Vehicle serviced</b> -Maintenance inspection completed -Anti-theft/keyless remote battery replaced -Battery/charging system checked
03/01/2019	44,191	Continental Audi of Naperville Naperville, IL 630-388-1000 continentalaudi.com		<b>Vehicle serviced</b> -Maintenance inspection completed
03/30/2019	45,659	Continental Audi of Naperville Naperville, IL 630-388-1000 continentalaudi.com		<b>Vehicle serviced</b> -Maintenance inspection completed -Tire condition and pressure checked
05/11/2019		Damage Report		<b>Accident reported with another motor vehicle</b>

05/11/2019

Damage Report



**Accident reported with another motor vehicle**

- Damage to rear
- Airbags did not deploy

**CARFAX HAS THE MOST ACCIDENT & DAMAGE INFORMATION**

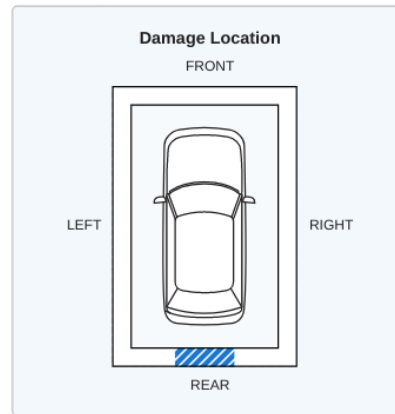

06/22/2019

Illinois  
Motor Vehicle Dept.  
Lisle, IL

**Registration issued or renewed**

07/26/2019

49,286

Continental Audi of Naperville  
Naperville, IL  
630-388-1000  
continentalaudi.com



**Vehicle serviced**

- Maintenance inspection completed
- Oil and filter changed

01/03/2020

Damage Report



**Accident reported**

- Involving rear impact with another motor vehicle
- Airbags did not deploy

**CARFAX HAS THE MOST ACCIDENT & DAMAGE INFORMATION**



05/21/2020

56,241

Continental Audi of Naperville  
Naperville, IL  
630-517-9235  
continentalaudi.com



**Vehicle serviced**

- Tire repaired

07/03/2020

Illinois  
Inspection Station  
Naperville, IL

**Passed emissions inspection**

07/07/2020

Illinois  
Motor Vehicle Dept.  
Woodridge, IL

**Registration issued or renewed**

- Correction to record
- Registration updated when owner moved the vehicle to a new location

07/31/2020







56,813

Continental Audi of Naperville  
Naperville, IL  
630-517-9235  
continentalaudi.com



**Vehicle serviced**

- Maintenance inspection completed
- 55,000 mile service performed
- Air filter replaced
- Battery/charging system checked
- Brakes checked
- Brake fluid flushed/changed
- Cabin air filter replaced/cleaned
- Exhaust system checked
- Fluids checked
- Oil and filter changed
- Parking brake adjusted

				- Oil and filter changed - Parking brake adjusted
03/05/2021	59,503	Audi Naperville Naperville, IL 630-882-2919 <a href="https://napervilleaudi.com">https://napervilleaudi.com</a> ❤️ 639 Customer Favorites		<b>Vehicle serviced</b> - Maintenance inspection completed
05/14/2021	60,935	Audi Naperville Naperville, IL 630-882-2919 <a href="https://napervilleaudi.com">https://napervilleaudi.com</a> ❤️ 639 Customer Favorites		<b>Vehicle serviced</b> - Maintenance inspection completed - Brake rotor(s) replaced - Front brake pads replaced - Front brake rotor(s) replaced
07/16/2021		Illinois Motor Vehicle Dept. Woodridge, IL		<b>Registration issued or renewed</b>
09/03/2021	63,651	Audi Naperville Naperville, IL 630-882-2919 <a href="https://napervilleaudi.com">https://napervilleaudi.com</a> ❤️ 639 Customer Favorites		<b>Vehicle serviced</b> - Maintenance inspection completed - Tire condition and pressure checked - Vehicle washed/detailed
11/16/2021	64,915	Audi Naperville Naperville, IL 630-882-2919 <a href="https://napervilleaudi.com">https://napervilleaudi.com</a> ❤️ 639 Customer Favorites		<b>Vehicle serviced</b> - Maintenance inspection completed - Oil and filter changed
06/30/2022	68,000	Illinois Inspection Station Naperville, IL		<b>Passed emissions inspection</b>
06/30/2022		Illinois Motor Vehicle Dept. Woodridge, IL		<b>Registration issued or renewed</b>
11/29/2022	70,843	Audi Westmont Westmont, IL 630-537-0310 <a href="http://laurelwestmontaudi.com">laurelwestmontaudi.com</a> ❤️ 3,896 Customer Favorites		<b>Vehicle serviced</b> - Maintenance inspection completed - 70,000 mile service performed - 75,000 mile service performed - Battery/charging system checked - Brakes checked - Brake fluid flushed/changed - Cabin air filter replaced/cleaned - Front wiper blades/refills replaced - Maintenance reminder reset - Oil and filter changed - Rear brake pads replaced - Rear brake rotor(s) replaced - Rear wiper blade replaced - Tire condition and pressure checked - Wipers/washers checked
07/07/2023		Illinois Motor Vehicle Dept. Woodridge, IL		<b>Registration issued or renewed</b>
12/01/2023		Illinois Motor Vehicle Dept. Woodridge, IL		<b>Registration issued or renewed</b> - Correction to record
01/26/2024	77,553	Audi Westmont Westmont, IL 630-537-0310 <a href="http://laurelwestmontaudi.com">laurelwestmontaudi.com</a> ❤️ 3,896 Customer Favorites		<b>Vehicle serviced</b> - Maintenance inspection completed - 75,000 mile service performed - Air filter cleaned - Battery/charging system checked - Body lubricated - Brakes checked - Cabin air filter replaced/cleaned - Cooling system checked - CV boot(s) checked - Decarbon service completed - Drivability/performance checked - Drive belts checked

- Drivability/performance checked
- Drive belts checked
- Exhaust system checked
- Front wiper blades/refills replaced
- Headlights adjusted
- Horns checked
- Instrument cluster checked
- Lights checked
- Maintenance reminder reset
- Oil and filter changed
- Paint sealant/protection checked
- Rear wiper blade replaced
- Safety inspection performed
- Seatbelts checked
- Spark plug(s) replaced
- Steering/suspension checked
- Sunroof checked
- Sunroof drain hoses serviced
- Tire condition and pressure checked
- Tires rotated
- Undercoating/rustproofing inspected
- Wipers/washers checked

06/12/2024

Damage Report



**Damage reported: very minor damage** ⓘ

- Damage to roof

**CARFAX HAS THE MOST ACCIDENT & DAMAGE INFORMATION**

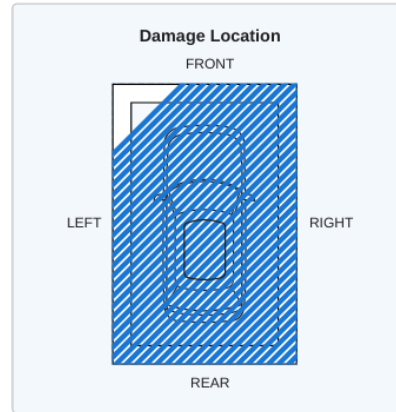
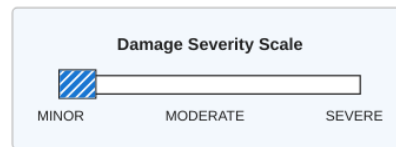

06/24/2024

79,888

Oil Depot  
Naperville, IL  
630-428-1850



**Vehicle serviced**

- Oil and filter changed

07/20/2024

80,112

Eagle Motorsport Used Cars  
Hobart, IN  
219-942-7775  
eaglemotorsport.net/

**Vehicle offered for sale**

07/26/2024

Michigan  
Motor Vehicle Dept.

**Vehicle purchase reported**

09/24/2024

Michigan  
Motor Vehicle Dept.  
Saint Joseph, MI

**Loan or lien reported**



**Owner 2**

Purchased: 2024

Personal Vehicle

9,574 mi/yr

Date	Mileage	Source	Comments
09/24/2024		Michigan Motor Vehicle Dept. Saint Joseph, MI Title #MI0023091286	<b>Title issued or updated</b> - New owner reported
11/16/2024	91,863	Performance Plus Quick Oil Change Saint Joseph, MI 269-982-0281	<b>Vehicle serviced</b> - Oil and filter changed - Vehicle washed/detailed

Saint Joseph, MI  
269-982-0281  
performanceplusoil.com/  
♥ 2 Customer Favorites

- Oil and filter changed  
- Vehicle washed/detailed

03/14/2025

Michigan  
Motor Vehicle Dept.  
Saint Joseph, MI

**Registration issued or renewed**

06/20/2025

Damage Report



**Damage reported: minor damage** ⓘ

- Damage to rear
- Damage to left side

**CARFAX HAS THE MOST ACCIDENT & DAMAGE INFORMATION**

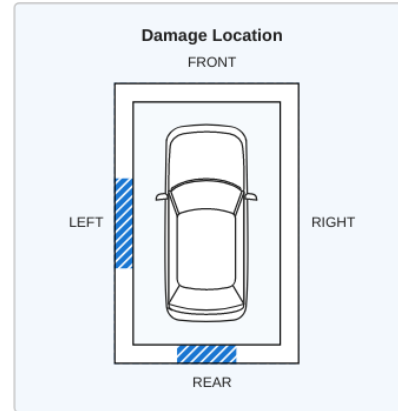
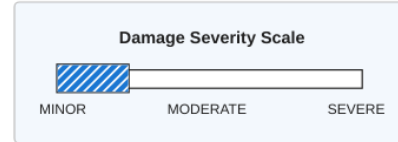

09/26/2025

Damage Report



**Accident reported**

- It hit a deer
  - It hit an animal
  - Damage to front
  - Disabling damage reported
  - Front airbag deployed
- [CARFAX Airbag Tips](#)

**CARFAX HAS THE MOST ACCIDENT & DAMAGE INFORMATION**

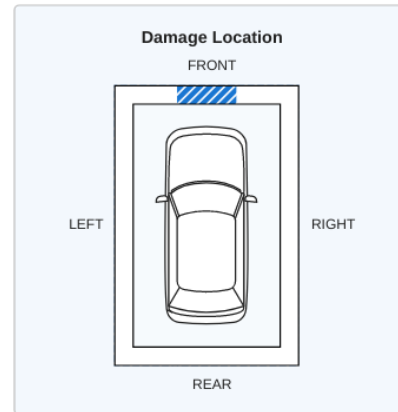

12/19/2025

Michigan  
Motor Vehicle Dept.  
Saint Joseph, MI  
Title #MI0028354676

**Title issued or updated**

- Correction to record

01/06/2026

Damage Report



**TOTAL LOSS VEHICLE**



There are many reasons an insurance company will declare a vehicle a total loss. Have this vehicle inspected by a qualified technician before you buy. [Learn More](#)

01/06/2026

102,775

Michigan  
Motor Vehicle Dept.  
Cleveland, OH  
Title #MI0028426460

**Vehicle purchase reported**

- Title or registration issued to insurance company

01/21/2026

Audi

**Connect Service available with subscription**

**Connect offers services to enhance navigation, infotainment, and peace of mind**

[Learn more](#)

Have Questions? Consumers, please visit our Help Center at [www.carfax.com](http://www.carfax.com). Dealers or Subscribers, please visit our Help Center at [www.carfaxonline.com](http://www.carfaxonline.com).

## **CARFAX** Glossary

[Full Glossary](#)

### **Accident Indicator**

CARFAX receives information about accidents in all 50 states, the District of Columbia and Canada.

Not every accident is reported to CARFAX. As details about the accident become available, those additional details are added to the CARFAX Vehicle History Report. CARFAX recommends that you have this vehicle inspected by a qualified mechanic.

- According to the National Safety Council, Injury Facts, 2021 edition, 5% of the 276 million registered vehicles in the U.S. were involved in an accident in 2019. Over 77% of these were considered minor or moderate.
- This CARFAX Vehicle History Report is based only on information supplied to CARFAX and available as of 1/21/26 at 2:26:07 PM (CST). Other information about this vehicle, including problems, may not have been reported to CARFAX. Use this report as one important tool, along with a vehicle inspection and test drive, to make a better decision about your next used car.

### **Airbag Deployment**

Occurs when the driver, passenger or side airbag has been used or deployed during a crash or other incident. If an airbag has been deployed, it must be replaced by a qualified technician. Have this car inspected by a mechanic prior to purchase.

### **Damage Indicator**

Damage can be a result of many different types of events. Examples include contact with objects (other cars, trees, traffic signs, road debris, etc), vandalism, or weather-related events. Not every damage event is reported to CARFAX. As details about the damage event become available, those additional details are added to the CARFAX Vehicle History Report. CARFAX recommends that you have this vehicle inspected by a qualified mechanic.

- This CARFAX Vehicle History Report is based only on information supplied to CARFAX and available as of 1/21/26 at 2:26:07 PM (CST). Other information about this vehicle, including problems, may not have been reported to CARFAX. Use this report as one important tool, along with a vehicle inspection and test drive, to make a better decision about your next used car.

### **Damage Severity**

Damage events result in one of the following severity levels:

- Minor: Generally, minor damage is cosmetic (including dents or scratches), may only require reconditioning, and typically does not compromise a vehicle's operation and/or safety.
- Moderate: Moderate damage may affect multiple components of the vehicle and may impair the vehicle's operation and/or safety.
- Severe: Severe damage usually affects multiple components of the vehicle and is likely to compromise the vehicle's operation and/or safety.

CARFAX recommends getting a pre-purchase inspection at a certified collision repair facility.

### **First Owner**

When the first owner(s) obtains a title from a Department of Motor Vehicles as proof of ownership.

### **New Owner Reported**

When a vehicle is sold to a new owner, the Title must be transferred to the new owner(s) at a Department of Motor Vehicles.

### **Ownership History**

CARFAX defines an owner as an individual or business that possesses and uses a vehicle. Not all title transactions represent changes in ownership. To provide estimated number of owners, CARFAX proprietary technology analyzes all the events in a vehicle history. Estimated ownership is available for vehicles manufactured after 1991 and titled solely in the US including Puerto Rico. Dealers sometimes opt to take ownership of a vehicle and are required to in the following states: Maine, Massachusetts, New Jersey, Ohio, Oklahoma, Pennsylvania and South Dakota. Please consider this as you review a vehicle's estimated ownership history.

### **Title Issued**

A state issues a title to provide a vehicle owner with proof of ownership. Each title has a unique number. Each title or registration record on a CARFAX report does not necessarily indicate a change in ownership. In Canada, a registration and bill of sale are used as proof of ownership.

### **Total Loss Vehicle**

An insurance or fleet company declares a vehicle a total loss when a claim exceeds approximately 75% of its pre-damage value or if the vehicle is stolen and not recovered. This damage threshold varies by company. These companies typically take possession and obtain the title. Not all total loss vehicles result in a DMV-reported branded title. This may occur when an insurance company's definition of a total loss is different than the state DMV's definition for a branded title or when the owner of the vehicle is a self-insured company, like a fleet or rental company.

Follow  
Us:



Us:



CARFAX DEPENDS ON ITS SOURCES FOR THE ACCURACY AND RELIABILITY OF ITS INFORMATION. THEREFORE, NO RESPONSIBILITY IS ASSUMED BY CARFAX OR ITS AGENTS FOR ERRORS OR OMISSIONS IN THIS REPORT. CARFAX FURTHER EXPRESSLY DISCLAIMS ALL WARRANTIES, EXPRESS OR IMPLIED, INCLUDING ANY IMPLIED WARRANTIES OF MERCHANTABILITY OR FITNESS FOR A PARTICULAR PURPOSE.

© 2026 CARFAX, Inc., part of S&P Global. All rights reserved.  
1/21/26 2:26:07 PM (CST)

**I have reviewed and received a copy of the CARFAX Vehicle History Report for this 2016 AUDI Q5 vehicle (VIN: WA1L2AFPXGA048086), which is based on information supplied to CARFAX and available as of 1/21/26 at 3:26 PM (EST).**

\_\_\_\_\_  
**Customer Signature**

\_\_\_\_\_  
**Date**

\_\_\_\_\_  
**Dealer Signature**

\_\_\_\_\_  
**Date**