

CARFAX History-Based Value Report

\$2,120

CARFAX Retail Value

History events affecting this vehicle's value

- Service History
- Personal Vehicle
- Not Actual Mileage
- Accident Reported

CARFAX Vehicle History Report™

US \$44.99

2011 AUDI Q5 2.0T QUATTRO PREMIUM PLUS

VIN: WA1LFAFP6BA096875
4 DOOR WAGON/SPORT UTILITY
2.0L I4 F DOHC 16V
GASOLINE
ALL WHEEL DRIVE

Branded Title: Not Actual Mileage >

Accident reported: minor to moderate damage >

MINOR MODERATE SEVERE

20 Service history records >

4 Previous owners >

Personal vehicle >

This CARFAX Vehicle History Report is based only on [information](#) supplied to CARFAX and available as of 3/1/26 at 3:49:27 PM (CST). Other information about this vehicle, including problems, may not have been reported to CARFAX. Use this report as one important tool, along with a vehicle inspection and test drive, to make a better decision about your next used car.

CARFAX Accident / Damage History

Not all accidents / issues are reported to CARFAX

Event 1

04/05/2017

Accident reported: minor to moderate damage ⓘ

- Vehicle involved in a rear-end collision
- Airbags did not deploy

[View More Details >](#)

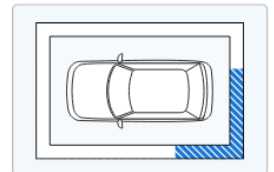
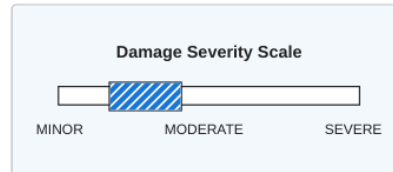

Event 2

01/12/2023

Damage reported: minor damage ⓘ

[View More Details >](#)

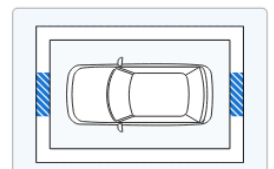
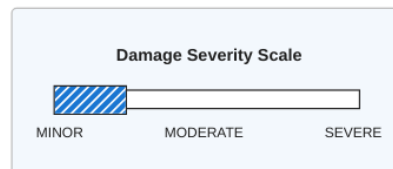

Event 3

02/24/2026

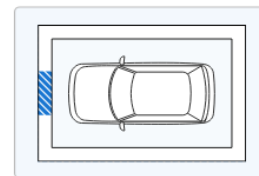
Damage reported[View More Details >](#)
CARFAX Additional History
 Not all accidents / issues are reported to CARFAX

| | 👤 Owners 1-2 | 👤 Owner 3 | 👤 Owner 4 |
|--|-----------------------------------|---------------------------------|----------------------------------|
| Total Loss ⓘ No total loss reported to CARFAX. | ✓ No Issues Reported | ✓ No Issues Reported | ✓ No Issues Reported |
| Structural Damage ⓘ CARFAX recommends that you have this vehicle inspected by a collision repair specialist. | ✓ No Issues Reported | ✓ No Issues Reported | ✓ No Issues Reported |
| Airbag Deployment ⓘ No airbag deployment reported to CARFAX. | ✓ No Issues Reported | ✓ No Issues Reported | ✓ No Issues Reported |
| Odometer Check ⓘ DMV title problems reported. | ✓ No Issues Indicated | ✓ No Issues Indicated | Odometer Problem |
| Accident / Damage ⓘ Accident reported: 04/05/2017. Damage reported: 01/12/2023 and 02/24/2026. | Accident Reported | Damage Reported | Damage Reported |
| Manufacturer Recall ⓘ No open recalls reported to CARFAX. | ✓ No Recalls Reported | ✓ No Recalls Reported | ✓ No Recalls Reported |
| Basic Warranty ⓘ Original warranty estimated to have expired. | Warranty Expired | Warranty Expired | Warranty Expired |

CARFAX Title History

| | 👤 Owners 1-2 | 👤 Owner 3 | 👤 Owner 4 |
|--|--------------|------------|--------------------------------|
| Damage Brands ⓘ Salvage Junk Rebuilt Fire Flood Hail Lemon | No Problem | No Problem | No Problem |
| Odometer Brands ⓘ Not Actual Mileage Exceeds Mechanical Limits | No Problem | No Problem | Alert! Problem Found |



ALERT! - Severe problems were reported by a state Department of Motor Vehicles (DMV). This vehicle does not qualify for the CARFAX Buyback Guarantee.

CARFAX Ownership History
 The number of owners is estimated

| | 👤 Owners 1-2 | 👤 Owner 3 | 👤 Owner 4 |
|---|-----------------------------|--------------|-------------|
| Year purchased | 2011 | 2021 | 2024 |
| Type of owner | Personal | Personal | Personal |
| Estimated length of ownership | 10 yrs. 4 mo. | 2 yrs. 5 mo. | 1 yr. 8 mo. |
| Owned in the following states/provinces | Texas, Texas | Texas | Texas |
| Estimated miles driven per year | See Details | 12,388/yr | --- |
| Last reported odometer reading | 117,803 | 149,931 | 142,825 |

Last reported odometer reading

117,803

149,931







142,825

 Detailed History
[Glossary](#)**Owner 1**

Purchased: 2011

Personal Vehicle

13,389 mi/yr

| Date | Mileage | Source | | Comments |
|------------|---------|--|---|---|
| 04/30/2011 | | NICB | | Vehicle manufactured and shipped to original dealer |
| 06/13/2011 | 50 | Texas Motor Vehicle Dept. Montgomery, TX Title #10170640692115918 | | Title issued or updated - First owner reported - Titled or registered as personal vehicle - Vehicle color noted as Black |
| 05/01/2012 | | Texas Motor Vehicle Dept. Montgomery, TX Title #10170640692115918 | | Registration issued or renewed - Passed safety inspection - Vehicle color noted as Black |
| 05/04/2012 | 18,432 | Central Houston Cadillac Houston, TX 713-874-0900 centralhoustoncadillac.com  7,347 Customer Favorites |  | Vehicle serviced |
| 05/01/2013 | | Texas Motor Vehicle Dept. Houston, TX Title #10170640692115918 | | Registration issued or renewed - Passed safety inspection - Vehicle color noted as Black |
| 08/11/2013 | 48,004 | Texas Inspection Station Houston, TX | | Passed emissions inspection |
| 08/09/2014 | | Texas Motor Vehicle Dept. Houston, TX Title #10170640692115918 | | Registration issued or renewed - Passed safety inspection - Vehicle color noted as Black |
| 09/21/2014 | 58,377 | Texas Inspection Station Houston, TX | | Passed emissions inspection |
| 05/01/2015 | | Texas Motor Vehicle Dept. Houston, TX Title #10170640692115918 | | Registration issued or renewed - Passed safety inspection - Vehicle color noted as Black |
| 03/29/2016 | 77,230 | Texas Inspection Station Houston, TX | | Passed emissions inspection |
| 05/01/2016 | | Texas Motor Vehicle Dept. Montgomery, TX Title #10170640692115918 | | Registration issued or renewed - Passed safety inspection - Vehicle color noted as Black |
| 12/03/2016 | | National Tire & Battery Houston, TX 713-621-4230 ntb.com  38 Customer Favorites |  | Vehicle serviced - Alignment performed - Battery/charging system checked - Tire condition and pressure checked - Tire repaired - Tire(s) balanced - Tire(s) replaced |
| 04/05/2017 | | Damage Report |  | Accident reported: minor to moderate damage  - Vehicle involved in a rear-end collision - Damage to left rear - Damage to rear |

- Vehicle involved in a rear-end collision
- Damage to left rear
- Damage to rear
- Airbags did not deploy

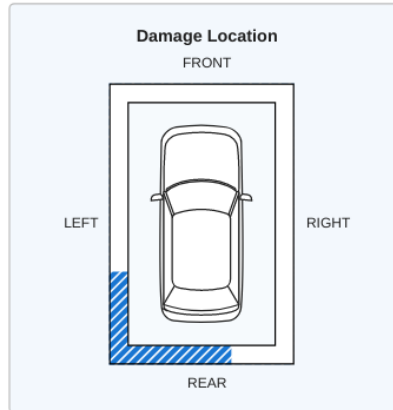
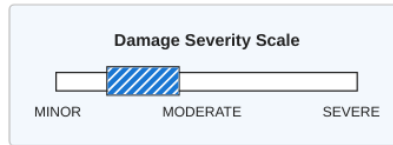



















CARFAX HAS THE MOST ACCIDENT & DAMAGE INFORMATION















| | | | | |
|------------|---------|--|--|--|
| 05/08/2017 | 89,387 | Texas Inspection Station Houston, TX | | Passed emissions inspection |
| 05/08/2017 | | Texas Motor Vehicle Dept. Montgomery, TX Title #10170640692115918 | | Registration issued or renewed - Passed safety inspection - Registration updated when owner moved the vehicle to a new location - Vehicle color noted as Black |
| 04/24/2018 | 97,384 | Texaco Xpress Lube Houston, TX 999-999-9999 | | Vehicle serviced - Emission system checked - Emissions inspection performed - Emissions or safety inspection performed |
| 04/24/2018 | | Texas Inspection Station Houston, TX | | Passed emissions inspection |
| 05/01/2018 | | Texas Motor Vehicle Dept. Montgomery, TX Title #10170640692115918 | | Registration issued or renewed - Passed safety inspection - Vehicle color noted as Black |
| 03/30/2019 | | Texas Motor Vehicle Dept. | | Vehicle purchase reported |
| 04/01/2019 | 104,511 | Auto Auction | | Listed as a dealer vehicle - Vehicle sold |
| 04/05/2019 | | Dealer Inventory | | Vehicle offered for sale |



Owner 2 Personal Vehicle
Purchased: 2019 5,986 mi/yr

| Date | Mileage | Source | Comments |
|------------|---------|--|---|
| 04/15/2019 | | Texas Motor Vehicle Dept. Montgomery, TX Title #26520043568085600 | Title issued or updated - New owner reported - Vehicle color noted as Black |
| 05/24/2019 | | Texas Motor Vehicle Dept. Plano, TX Title #05745943599101512 | Title issued or updated - Duplicate title issued - Loan or lien reported - Vehicle color noted as Black |
| 10/07/2019 | 106,093 | Kwik Kar Ohio 121 | Vehicle serviced |

| | | | | |
|------------|---------|---|---|--|
| 10/07/2019 | 106,093 | Kwik Kar Ohio 121 Plano, TX 469-633-1521  56 Customer Favorites |  | Vehicle serviced -Maintenance inspection completed -Battery/charging system checked -Oil and filter changed |
| 01/07/2020 | 107,255 | Brakes Plus #304 Plano, TX 972-377-6599  140 Customer Favorites |  | Vehicle serviced -Battery/charging system checked |
| 02/11/2020 | 107,816 | Pep Boys Frisco, TX 469-333-2696 pepboys.com  40 Customer Favorites |  | Vehicle serviced -Maintenance inspection completed -Brakes checked -Brake fluid flushed/changed -Front brake pads replaced -Front brake rotor(s) replaced |
| 03/10/2020 | 108,174 | Kwik Kar Ohio 121 Plano, TX 469-633-1521  56 Customer Favorites |  | Vehicle serviced -Maintenance inspection completed -Air filter checked -Oil and filter changed |
| 04/28/2020 | 108,661 | Texas Inspection Station Plano, TX | | Passed emissions inspection |
| 04/29/2020 | | Just Tires Plano, TX 972-377-0138  2 Customer Favorites |  | Vehicle serviced -Alignment checked -Tire condition and pressure checked -Tire(s) replaced |
| 04/29/2020 | 108,680 | Texas Inspection Station Plano, TX | | Passed emissions inspection |
| 05/01/2020 | | Texas Motor Vehicle Dept. Plano, TX Title #05745943599101512 | | Registration issued or renewed -Duplicate title issued -Loan or lien reported -Passed safety inspection -Registration updated when owner moved the vehicle to a new location -Vehicle color noted as Black |
| 01/23/2021 | 113,824 | Just Tires Plano, TX 972-377-0138  2 Customer Favorites |  | Vehicle serviced |
| 03/12/2021 | 114,876 | Kwik Kar Ohio 121 Plano, TX 469-633-1521  56 Customer Favorites |  | Vehicle serviced -Maintenance inspection completed -Oil and filter changed |
| 04/20/2021 | 115,703 | Brakes Plus #304 Plano, TX 972-377-6599  140 Customer Favorites |  | Vehicle serviced -Battery/charging system checked -Oil and filter changed |
| 04/20/2021 | | Just Tires Plano, TX 972-377-0138  2 Customer Favorites |  | Vehicle serviced -Tire condition and pressure checked -Tire(s) replaced |
| 04/20/2021 | 115,704 | Texas Inspection Station Plano, TX | | Passed emissions inspection |
| 04/20/2021 | 115,715 | Texas Inspection Station Plano, TX | | Passed emissions inspection |
| 05/01/2021 | | Texas | | Registration issued or renewed |

| | | | | |
|------------|---------|--|---|---|
| 05/01/2021 | | Texas Motor Vehicle Dept. Plano, TX Title #05745943599101512 | | Registration issued or renewed - Duplicate title issued - Loan or lien reported - Passed safety inspection - Vehicle color noted as Black |
| 07/08/2021 | 117,701 | Brakes Plus #304 Plano, TX 972-377-6599  140 Customer Favorites |  | Vehicle serviced - Four wheel alignment performed - Spark plug(s) replaced |
| 07/24/2021 | | Texas Motor Vehicle Dept. Plano, TX Title #28695344398005856 | | Title issued or updated - Loan or lien released - Vehicle color noted as Black |
| 07/28/2021 | 117,777 | Texas Inspection Station Plano, TX | | Passed emissions inspection |
| 07/29/2021 | | David McDavid Honda Frisco Frisco, TX 469-606-2370 mcdavidhondafrisco.com/  1,567 Customer Favorites |  | Vehicle serviced - Pre-delivery inspection completed - A/C refrigerant recharged - Brakes checked - Front wiper blades/refills replaced - Emissions inspection performed - Upper control arm(s) replaced - Wiper(s) replaced - Vehicle washed/detailed |
| 08/10/2021 | | David McDavid Honda Frisco Frisco, TX 469-606-2370 mcdavidhondafrisco.com/  1,567 Customer Favorites |  | Vehicle serviced |
| 08/30/2021 | 117,800 | David McDavid Honda Frisco Frisco, TX 469-606-2370 mcdavidhondafrisco.com/  1,567 Customer Favorites |  | Vehicle serviced - Battery/charging system checked - Battery replaced |
| 09/17/2021 | | David McDavid Honda Frisco Frisco, TX 469-606-2370 mcdavidhondafrisco.com/  1,567 Customer Favorites |  | Vehicle serviced |
| 09/20/2021 | 117,803 | Audi Plano Plano, TX 972-249-0905 audiplano.com  302 Customer Favorites |  | Vehicle serviced - Maintenance inspection completed - Battery/charging system checked - Brakes checked - Starter replaced - Tire condition and pressure checked |

| | |
|--|----------------------------------|
|  Owner 3 Purchased: 2021 | Personal Vehicle 12,388 mi/yr |
|--|----------------------------------|

| Date | Mileage | Source | Comments |
|------------|---------|--|--|
| 11/04/2021 | 117,822 | Texas Motor Vehicle Dept. Frisco, TX Title #04336744494250045 | Title issued or updated - New owner reported - Loan or lien reported - Vehicle color noted as Black |
| 12/31/2022 | 137,873 | Take 5 Oil Change Frisco, TX 469-200-2672 take5oilchange.com  5 Customer Favorites |  Vehicle serviced - Oil and filter changed |

| | | | |
|------------|--|---------------|--|
| 01/12/2023 | | Damage Report |  Damage reported: minor damage  |
|------------|--|---------------|--|

01/12/2023

Damage Report



Damage reported: minor damage

- Damage to rear
- Damage to front

CARFAX HAS THE MOST ACCIDENT & DAMAGE INFORMATION

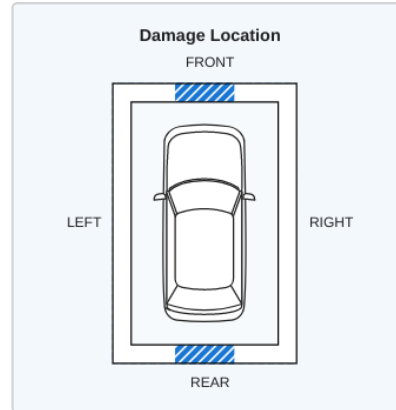

04/26/2024

Online Listing

Vehicle offered for sale

05/11/2024

Texas
 Motor Vehicle Dept.
 Frisco, TX
 Title #28695345420006215

Title issued or updated
 - Loan or lien released
 - Vehicle color noted as Black

06/07/2024

149,931

Audi Grapevine
 Grapevine, TX
 817-354-2834
 audigrapevine.com/



Vehicle serviced

♥ 218 Customer Favorites



Owner 4

Purchased: 2024

Personal Vehicle

| Date | Mileage | Source | Comments |
|------|---------|--------|----------|
|------|---------|--------|----------|

06/08/2024 142,825 Texas
 Motor Vehicle Dept.
 Arlington, TX
 Title #05780445441091154



New owner reported
 - NOT ACTUAL MILEAGE TITLE ISSUED
 - Vehicle color noted as Black



A NAM title is issued when the owner discloses to a DMV mileage fraud, a broken odometer or that the actual mileage of this vehicle is unknown. Mileage reported after this reading is potentially unreliable.

02/12/2026

Texas
 Motor Vehicle Dept.
 Arlington, TX
 Title #26731046063142433



NOT ACTUAL MILEAGE TITLE ISSUED
 - Vehicle color noted as Black

02/24/2026

Damage Report



Damage reported
 - Damage to front

CARFAX HAS THE MOST ACCIDENT & DAMAGE INFORMATION

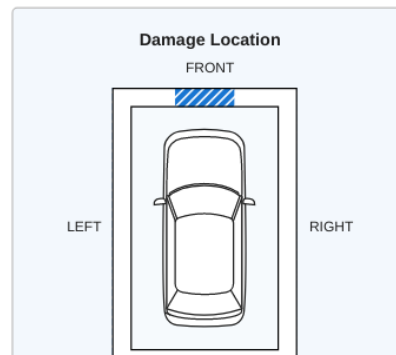



Have Questions? Consumers, please visit our Help Center at www.carfax.com. Dealers or Subscribers, please visit our Help Center at www.carfaxonline.com.

Accident Indicator

CARFAX receives information about accidents in all 50 states, the District of Columbia and Canada.

Not every accident is reported to CARFAX. As details about the accident become available, those additional details are added to the CARFAX Vehicle History Report. CARFAX recommends that you have this vehicle inspected by a qualified mechanic.

- According to the National Safety Council, Injury Facts, 2021 edition, 5% of the 276 million registered vehicles in the U.S. were involved in an accident in 2019. Over 77% of these were considered minor or moderate.
- This CARFAX Vehicle History Report is based only on information supplied to CARFAX and available as of 3/1/26 at 3:49:27 PM (CST). Other information about this vehicle, including problems, may not have been reported to CARFAX. Use this report as one important tool, along with a vehicle inspection and test drive, to make a better decision about your next used car.

Damage Indicator

Damage can be a result of many different types of events. Examples include contact with objects (other cars, trees, traffic signs, road debris, etc), vandalism, or weather-related events. Not every damage event is reported to CARFAX. As details about the damage event become available, those additional details are added to the CARFAX Vehicle History Report. CARFAX recommends that you have this vehicle inspected by a qualified mechanic.

- This CARFAX Vehicle History Report is based only on information supplied to CARFAX and available as of 3/1/26 at 3:49:27 PM (CST). Other information about this vehicle, including problems, may not have been reported to CARFAX. Use this report as one important tool, along with a vehicle inspection and test drive, to make a better decision about your next used car.

Damage Severity

Damage events result in one of the following severity levels:

- Minor: Generally, minor damage is cosmetic (including dents or scratches), may only require reconditioning, and typically does not compromise a vehicle's operation and/or safety.
- Moderate: Moderate damage may affect multiple components of the vehicle and may impair the vehicle's operation and/or safety.
- Severe: Severe damage usually affects multiple components of the vehicle and is likely to compromise the vehicle's operation and/or safety.

CARFAX recommends getting a pre-purchase inspection at a certified collision repair facility.

Federal Odometer Act

The Federal Odometer Act requires a seller to disclose the vehicle's mileage on the title when ownership is transferred. Congress enacted this Act to prohibit odometer tampering and to protect consumers from mileage fraud. Under this act, sellers must disclose any issues with the vehicle's odometer. These disclosures translate into the Exceed Mechanical Limits and Not Actual Mileage titles.

First Owner

When the first owner(s) obtains a title from a Department of Motor Vehicles as proof of ownership.

New Owner Reported

When a vehicle is sold to a new owner, the Title must be transferred to the new owner(s) at a Department of Motor Vehicles.

Not Actual Mileage Title

When the seller certifies, under the Federal Odometer Act, that the odometer reading does not reflect the vehicle's actual mileage. This may occur because the odometer was tampered with, broken, or replaced.

Ownership History

CARFAX defines an owner as an individual or business that possesses and uses a vehicle. Not all title transactions represent changes in ownership. To provide estimated number of owners, CARFAX proprietary technology analyzes all the events in a vehicle history. Estimated ownership is available for vehicles manufactured after 1991 and titled solely in the US including Puerto Rico. Dealers sometimes opt to take ownership of a vehicle and are required to in the following states: Maine, Massachusetts, New Jersey, Ohio, Oklahoma, Pennsylvania and South Dakota. Please consider this as you review a vehicle's estimated ownership history.

Title Issued

A state issues a title to provide a vehicle owner with proof of ownership. Each title has a unique number. Each title or registration record on a CARFAX report does not necessarily indicate a change in ownership. In Canada, a registration and bill of sale are used as proof of ownership.

Follow Us:



CARFAX DEPENDS ON ITS SOURCES FOR THE ACCURACY AND RELIABILITY OF ITS INFORMATION. THEREFORE, NO RESPONSIBILITY IS ASSUMED BY CARFAX OR ITS AGENTS FOR ERRORS OR OMISSIONS IN THIS REPORT. CARFAX FURTHER EXPRESSLY DISCLAIMS ALL WARRANTIES, EXPRESS OR IMPLIED, INCLUDING ANY IMPLIED WARRANTIES OF MERCHANTABILITY OR FITNESS FOR A PARTICULAR PURPOSE.

© 2026 CARFAX, Inc., part of S&P Global. All rights reserved.

3/1/26 3:49:27 PM (CST)

I have reviewed and received a copy of the CARFAX Vehicle History Report for this 2011 AUDI Q5 vehicle (VIN: WA1LFAP6BA096875), which is based on information supplied to CARFAX and available as of 3/1/26 at 4:49 PM (EST).

Customer Signature

Date

Dealer Signature

Date