

CARFAX History-Based Value Report

[Hide](#)

\$18,060

CARFAX Retail Value

Retail
 Wholesale

History events affecting this vehicle's value

- 1-Owner Vehicle
- Service History
- Personal Vehicle
- Total Loss

CARFAX Vehicle History Report™

US \$44.99

2019 AUDI Q7 QUATTRO PREMIUM PLUS 45 TFSI

VIN: WA1LHAF7XKD034291
 4 DOOR WAGON/SPORT UTILITY
 2.0L I4 F DOHC 16V
 GASOLINE
 ALL WHEEL DRIVE

- Total loss vehicle >
- 11 Service history records >
- CARFAX 1-Owner vehicle >
- Personal vehicle >
- Last owned in Texas >
- 65,865 Last reported odometer reading >

CARFAX HAS THE MOST ACCIDENT & DAMAGE INFORMATION



This CARFAX Vehicle History Report is based only on [information](#) supplied to CARFAX and available as of 12/15/25 at 3:11:26 AM (CST). Other information about this vehicle, including problems, may not have been reported to CARFAX. Use this report as one important tool, along with a vehicle inspection and test drive, to make a better decision about your next used car.

CARFAX Accident / Damage History

Not all accidents / issues are reported to CARFAX

Event 1

10/27/2020

Damage reported: minor damage

[View More Details >](#)

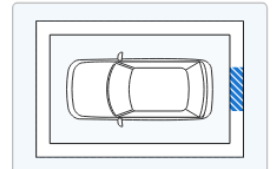
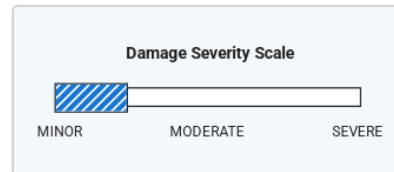

Event 2

07/29/2025

Accident reported: minor damage

[View More Details >](#)

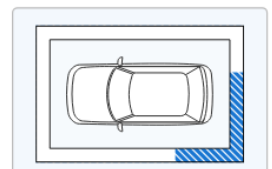
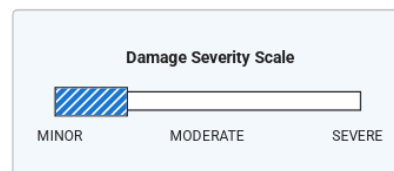

Event 3

11/21/2025

11/21/2025

TOTAL LOSS VEHICLE

[View More Details >](#)

CARFAX Recent Service Highlights

Key services performed in the last 12 months

Service & Comments	Service	Comments	View Details Links
Oil	✓ Oil and filter changed	07/01/2025	View Details >
Tires	✓ Tires rotated	12/16/2024	View Details >



This car has been recently serviced. That's a good thing!

CARFAX Additional History

Not all accidents / issues are reported to CARFAX

Owner 1

Total Loss ⓘ

Total Loss Reported: 11/21/2025.

[Total Loss Reported](#)

Structural Damage ⓘ

CARFAX recommends that you have this vehicle inspected by a collision repair specialist.

✓ No Issues Reported

Airbag Deployment ⓘ

No airbag deployment reported to CARFAX.

✓ No Issues Reported

Odometer Check ⓘ

No indication of an odometer rollback.

✓ No Issues Indicated

Accident / Damage ⓘ

Damage reported: 10/27/2020. Accident reported: 07/29/2025.

[Accident Reported](#)

Manufacturer Recall ⓘ

No open recalls reported to CARFAX.

✓ No Recalls Reported

Basic Warranty ⓘ

[Original warranty](#) estimated to have expired.

Warranty Expired

CARFAX Title History

CARFAX guarantees the information in this section

Owner 1

Damage Brands ⓘ

Salvage | Junk | Rebuilt | Fire | Flood | Hail | Lemon

✓ **Guaranteed**
No Problem

Odometer Brands ⓘ

Not Actual Mileage | Exceeds Mechanical Limits

✓ **Guaranteed**
No Problem



GUARANTEED - None of these title problems were reported by a U.S. state Department of Motor Vehicles (DMV). If you find that any of these title problems were reported by a DMV and not included in this report, you may qualify.

[View Terms](#) | [View Certificate](#)

CARFAX Ownership History

The number of owners is estimated

Owner 1

Year started

2010

Year purchased	2019
Type of owner	Personal
Estimated length of ownership	6 years
Owned in the following states/provinces	Texas
Estimated miles driven per year	10,853/yr
Last reported odometer reading	65,865

CARFAX Detailed History

[Glossary](#)

Owner 1 Personal Vehicle
Purchased: 2019 10,853 mi/yr

Date	Mileage	Source	Comments
Not Reported		NICB	Vehicle manufactured and shipped to original dealer
06/27/2019	10	Audi Dominion San Antonio, TX 210-681-3399 audidominion.com ★ 4.5 / 5.0 1,049 Verified Reviews ✓ ♥ 14,754 Customer Favorites	Vehicle offered for sale
06/27/2019	14	Audi Dominion San Antonio, TX 210-681-3399 audidominion.com/ ★ 4.5 / 5.0 1,049 Verified Reviews ✓ ♥ 14,754 Customer Favorites	Vehicle serviced - Fabric protection applied - Emissions or safety inspection performed - Paint protection applied - Window tint installed - Vehicle washed/detailed
06/29/2019		Texas Inspection Station	Passed safety inspection
10/03/2019	42	Audi Dominion San Antonio, TX 210-681-3399 audidominion.com ★ 4.5 / 5.0 1,049 Verified Reviews ✓ ♥ 14,754 Customer Favorites	Vehicle sold
10/04/2019		Audi Dominion San Antonio, TX 210-681-3399 audidominion.com/ ★ 4.5 / 5.0 1,049 Verified Reviews ✓ ♥ 14,754 Customer Favorites	Vehicle serviced - Vehicle washed/detailed
10/17/2019	50	Audi Dominion San Antonio, TX 210-681-3399 audidominion.com/ ★ 4.5 / 5.0 1,049 Verified Reviews ✓ ♥ 14,754 Customer Favorites	Vehicle serviced
10/29/2019		Texas Motor Vehicle Dept. Boerne, TX	Title issued or updated - First owner reported - Titled or registered as personal vehicle

Motor Vehicle Dept.
Boerne, TX
Title #01541943758250010

- First owner reported
- Titled or registered as personal vehicle
- Loan or lien reported
- Vehicle color noted as Black

08/15/2020 7,814

Audi Dominion
San Antonio, TX
210-681-3399
audidominion.com/



Vehicle serviced

- Maintenance inspection completed
- Oil and filter changed
- Oil pan drain plug replaced

★ 4.5 / 5.0 [1,049 Verified Reviews](#) ✓
♥ 14,754 Customer Favorites

10/27/2020

Damage Report



Damage reported: minor damage ⓘ

- Damage to rear

**CARFAX HAS THE MOST
ACCIDENT & DAMAGE
INFORMATION**

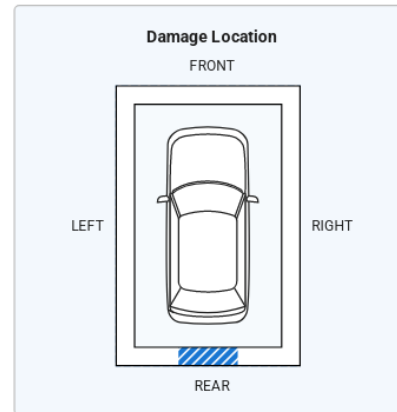
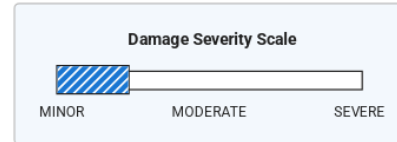

11/25/2020 9,628

Audi Dominion
San Antonio, TX
210-681-3399
audidominion.com/



Vehicle serviced

- Maintenance inspection completed
- Four wheel alignment performed

★ 4.5 / 5.0 [1,049 Verified Reviews](#) ✓
♥ 14,754 Customer Favorites

03/20/2021 12,124

Audi Dominion
San Antonio, TX
210-681-3399
audidominion.com/



Vehicle serviced

- Maintenance inspection completed

★ 4.5 / 5.0 [1,049 Verified Reviews](#) ✓
♥ 14,754 Customer Favorites

09/10/2021

Texas
Inspection Station

Passed safety inspection

09/18/2021 15,100

Audi Dominion
San Antonio, TX
210-681-3399
audidominion.com/



Vehicle serviced

- Maintenance inspection completed
- Oil and filter changed
- Oil pan drain plug replaced
- Vehicle washed/detailed

★ 4.5 / 5.0 [1,049 Verified Reviews](#) ✓
♥ 14,754 Customer Favorites

10/01/2021 15,261

Texas
Inspection Station

Passed safety inspection

10/01/2021

Texas
Motor Vehicle Dept.
Boerne, TX
Title #01541943758250010





Registration issued or renewed

- Loan or lien reported
- Passed safety inspection
- Vehicle color noted as Black

09/30/2022 25,336

Texas
Inspection Station

Passed safety inspection

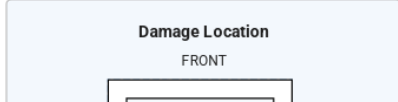
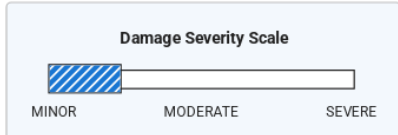

10/01/2022		Texas Motor Vehicle Dept. Boerne, TX Title #01541943758250010		Registration issued or renewed - Loan or lien reported - Passed safety inspection - Vehicle color noted as Black
11/02/2022	26,729	Audi Dominion San Antonio, TX 210-681-3399 audidominion.com/ ★ 4.5 / 5.0 1,049 Verified Reviews ✓ ♥ 14,754 Customer Favorites		Vehicle serviced - Maintenance inspection completed - Oil and filter changed
09/30/2023		Texas Inspection Station		Passed safety inspection
10/01/2023		Texas Motor Vehicle Dept. Boerne, TX Title #01541943758250010		Registration issued or renewed - Loan or lien reported - Passed safety inspection - Vehicle color noted as Black
12/21/2023	36,961	Audi Dominion San Antonio, TX 210-681-3399 audidominion.com/ ★ 4.5 / 5.0 1,049 Verified Reviews ✓ ♥ 14,754 Customer Favorites		Vehicle serviced - Maintenance inspection completed - 40,000 mile service performed - Brakes checked - Brake fluid flushed/changed - Oil and filter changed - Spark plug(s) replaced - Vehicle washed/detailed
09/30/2024	46,553	Texas Inspection Station		Passed safety inspection
10/01/2024		Texas Motor Vehicle Dept. Boerne, TX Title #01541943758250010		Registration issued or renewed - Loan or lien reported - Passed safety inspection - Vehicle color noted as Black
10/25/2024		Texas Motor Vehicle Dept. Boerne, TX Title #28695345587008064		Title issued or updated - Vehicle color noted as Black
12/16/2024	50,045	Audi Dominion San Antonio, TX 210-681-3399 audidominion.com/ ★ 4.5 / 5.0 1,049 Verified Reviews ✓ ♥ 14,754 Customer Favorites		Vehicle serviced - Maintenance inspection completed - Oil and filter changed - Tires rotated - Vehicle washed/detailed
07/01/2025	61,439	Audi Dominion San Antonio, TX 210-681-3399 audidominion.com/ ★ 4.5 / 5.0 1,049 Verified Reviews ✓ ♥ 14,754 Customer Favorites		Vehicle serviced - Maintenance inspection completed - Oil and filter changed

07/29/2025		Damage Report		Accident reported: minor damage ⓘ - Damage to rear - Damage to left rear
------------	--	---------------	---	---

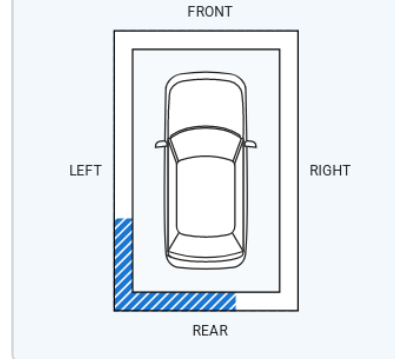

CARFAX HAS THE MOST ACCIDENT & DAMAGE INFORMATION



10/01/2025		Texas Motor Vehicle Dept. Boerne, TX Title #28695345587008064	Registration issued or renewed - Passed safety inspection - Vehicle color noted as Black
11/21/2025		Damage Report	 TOTAL LOSS VEHICLE
			<div style="border: 1px solid blue; padding: 5px;"> <p>There are many reasons an insurance company will declare a vehicle a total loss. Have this vehicle inspected by a qualified technician before you buy. Learn More</p> </div>
11/21/2025	65,865	Texas Motor Vehicle Dept. Austin, TX Title #01130945972250323	Title or registration issued to insurance company - Vehicle color noted as Black
12/15/2025		Audi	Connect Service available with subscription Connect offers services to enhance navigation, infotainment, and peace of mind Learn more

Have Questions? Consumers, please visit our Help Center at www.carfax.com. Dealers or Subscribers, please visit our Help Center at www.carfaxonline.com.

CARFAX Glossary

[Full Glossary](#)

Accident Indicator

CARFAX receives information about accidents in all 50 states, the District of Columbia and Canada.

Not every accident is reported to CARFAX. As details about the accident become available, those additional details are added to the CARFAX Vehicle History Report. CARFAX recommends that you have this vehicle inspected by a qualified mechanic.

- According to the National Safety Council, Injury Facts, 2021 edition, 5% of the 276 million registered vehicles in the U.S. were involved in an accident in 2019. Over 77% of these were considered minor or moderate.
- This CARFAX Vehicle History Report is based only on information supplied to CARFAX and available as of 12/15/25 at 3:11:26 AM (CST). Other information about this vehicle, including problems, may not have been reported to CARFAX. Use this report as one important tool, along with a vehicle inspection and test drive, to make a better decision about your next used car.

Damage Indicator

Damage can be a result of many different types of events. Examples include contact with objects (other cars, trees, traffic signs, road debris, etc), vandalism, or weather-related events. Not every damage event is reported to CARFAX. As details about the damage event become available, those additional details are added to the CARFAX Vehicle History Report. CARFAX recommends that you have this vehicle inspected by a qualified mechanic.

- This CARFAX Vehicle History Report is based only on information supplied to CARFAX and available as of 12/15/25 at 3:11:26 AM (CST). Other information about this vehicle, including problems, may not have been reported to CARFAX. Use this report as one important tool, along with a vehicle inspection and test drive, to make a better decision about your next used car.

Damage Severity

Damage events result in one of the following severity levels:

- Minor: Generally, minor damage is cosmetic (including dents or scratches), may only require reconditioning, and typically does not compromise a vehicle's operation and/or safety.
- Moderate: Moderate damage may affect multiple components of the vehicle and may impair the vehicle's operation and/or safety.
- Severe: Severe damage usually affects multiple components of the vehicle and is likely to compromise the vehicle's operation and/or safety.

CARFAX recommends getting a pre-purchase inspection at a certified collision repair facility.

CARFAX recommends getting a pre-purchase inspection at a certified collision repair facility.

First Owner

When the first owner(s) obtains a title from a Department of Motor Vehicles as proof of ownership.

Ownership History

CARFAX defines an owner as an individual or business that possesses and uses a vehicle. Not all title transactions represent changes in ownership. To provide estimated number of owners, CARFAX proprietary technology analyzes all the events in a vehicle history. Estimated ownership is available for vehicles manufactured after 1991 and titled solely in the US including Puerto Rico. Dealers sometimes opt to take ownership of a vehicle and are required to in the following states: Maine, Massachusetts, New Jersey, Ohio, Oklahoma, Pennsylvania and South Dakota. Please consider this as you review a vehicle's estimated ownership history.

Title Issued

A state issues a title to provide a vehicle owner with proof of ownership. Each title has a unique number. Each title or registration record on a CARFAX report does not necessarily indicate a change in ownership. In Canada, a registration and bill of sale are used as proof of ownership.

Total Loss Vehicle

An insurance or fleet company declares a vehicle a total loss when a claim exceeds approximately 75% of its pre-damage value or if the vehicle is stolen and not recovered. This damage threshold varies by company. These companies typically take possession and obtain the title. Not all total loss vehicles result in a DMV-reported branded title. This may occur when an insurance company's definition of a total loss is different than the state DMV's definition for a branded title or when the owner of the vehicle is a self-insured company, like a fleet or rental company.

Follow Us:  facebook.com/CARFAX  [@CARFAXinc](https://twitter.com/CARFAXinc)  [About CARFAX](#)

CARFAX DEPENDS ON ITS SOURCES FOR THE ACCURACY AND RELIABILITY OF ITS INFORMATION. THEREFORE, NO RESPONSIBILITY IS ASSUMED BY CARFAX OR ITS AGENTS FOR ERRORS OR OMISSIONS IN THIS REPORT. CARFAX FURTHER EXPRESSLY DISCLAIMS ALL WARRANTIES, EXPRESS OR IMPLIED, INCLUDING ANY IMPLIED WARRANTIES OF MERCHANTABILITY OR FITNESS FOR A PARTICULAR PURPOSE.

© 2025 CARFAX, Inc., part of S&P Global. All rights reserved.
12/15/25 3:11:26 AM (CST)

I have reviewed and received a copy of the CARFAX Vehicle History Report for this 2019 AUDI Q7 vehicle (VIN: WA1LHAF7XKD034291), which is based on information supplied to CARFAX and available as of 12/15/25 at 4:11 AM (EST).

Customer Signature

Date

Dealer Signature

Date