

CARFAX History-Based Value Report

[Hide](#)

\$17,060

CARFAX Retail Value

Retail Wholesale

History events affecting this vehicle's value

- Service History
- Personal Vehicle
- Total Loss
- Open Recall

CARFAX Vehicle History Report™

US \$44.99

2019 AUDI A5 SPORTBACK QUATTRO PREMIUM PLUS 45 TFSI

VIN: WAUENCF53KA029708
HATCHBACK 4 DR
2.0L I4 F DOHC 16V
GASOLINE
ALL WHEEL DRIVE

- Total loss vehicle >
- 15 Service history records >
- At least 1 open recall >
- 3 Previous owners >
- Types of owners: Personal lease, Personal >
- 78,614 Last reported odometer reading >

CARFAX HAS THE MOST
ACCIDENT & DAMAGE
INFORMATION



This CARFAX Vehicle History Report is based only on [information](#) supplied to CARFAX and available as of 9/29/25 at 2:34:18 PM (CDT). Other information about this vehicle, including problems, may not have been reported to CARFAX. Use this report as one important tool, along with a vehicle inspection and test drive, to make a better decision about your next used car.

CARFAX Accident / Damage History

Not all accidents / issues are reported to CARFAX

Event 1

12/06/2019

Damage reported: minor damage ⓘ

[View More Details >](#)

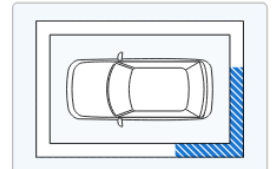
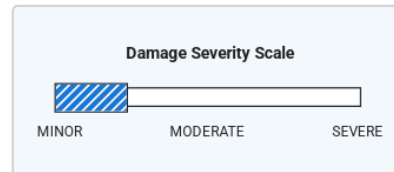

Event 2

03/12/2020

Accident reported: minor damage with another motor vehicle ⓘ

[View More Details >](#)

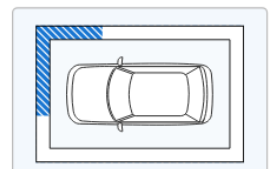
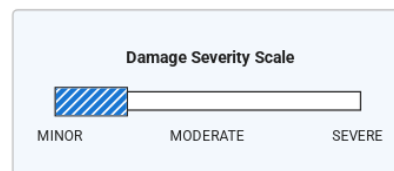

Event 3

06/27/2022

06/27/2022

Damage reported: minor damage ⓘ

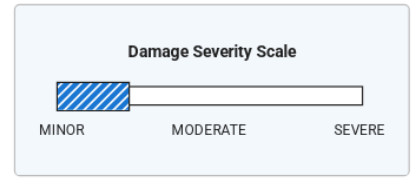

Show More ▾

CARFAX Recent Service Highlights

Key services performed in the last 12 months

Service & Comments	Service	Comments	View Details Links
Oil	✓ Oil and filter changed	10/27/2024	View Details >

This car has been recently serviced. That's a good thing!

CARFAX Additional History

Not all accidents / issues are reported to CARFAX

	Owner 1	Owner 2	Owner 3
Total Loss ⓘ Total Loss Reported: 09/16/2025.	✓ No Issues Reported	✓ No Issues Reported	Total Loss Reported
Structural Damage ⓘ CARFAX recommends that you have this vehicle inspected by a collision repair specialist.	✓ No Issues Reported	✓ No Issues Reported	✓ No Issues Reported
Airbag Deployment ⓘ No airbag deployment reported to CARFAX.	✓ No Issues Reported	✓ No Issues Reported	✓ No Issues Reported
Odometer Check ⓘ No indication of an odometer rollback.	✓ No Issues Indicated	✓ No Issues Indicated	✓ No Issues Indicated
Accident / Damage ⓘ Damage reported: 12/06/2019 and 06/27/2022. Accidents reported: 03/12/2020 and 03/17/2025.	Accident Reported	Damage Reported	Accident Reported
Manufacturer Recall ⓘ At least 1 manufacturer recall requires service. Locate an authorized Audi dealer to obtain more information about this recall.	✓ No Recalls Reported	Recall Reported	No New Recalls Reported
Basic Warranty ⓘ Original warranty estimated to have expired.	Warranty Expired	Warranty Expired	Warranty Expired

CARFAX Title History

CARFAX guarantees the information in this section

	Owner 1	Owner 2	Owner 3
Damage Brands ⓘ Salvage Junk Rebuilt Fire Flood Hail Lemon	✓ Guaranteed No Problem	✓ Guaranteed No Problem	✓ Guaranteed No Problem
Odometer Brands ⓘ Not Actual Mileage Exceeds Mechanical Limits	✓ Guaranteed No Problem	✓ Guaranteed No Problem	✓ Guaranteed No Problem



GUARANTEED - None of these title problems were reported by a U.S. state Department of Motor Vehicles (DMV). If you find that any of these title problems were reported by a DMV and not included in this report, you may qualify.

[View Terms](#) | [View Certificate](#)

CARFAX Ownership History

Owner 1	Owner 2	Owner 3
---------	---------	---------

CARFAX Ownership History
The number of owners is estimated





	Owner 1	Owner 2	Owner 3
Year purchased	2019	2020	2023
Type of owner	Personal lease	Personal	Personal
Estimated length of ownership	6 months	2 yrs. 5 mo.	2 yrs. 4 mo.
Owned in the following states/provinces	New Jersey, New York	New York	Texas, Oklahoma
Estimated miles driven per year	—	8,678/yr	20,117/yr
Last reported odometer reading	6,120	29,961	78,614

CARFAX Detailed History

[Glossary](#)

Owner 1
Purchased: 2019

Personal Lease Vehicle

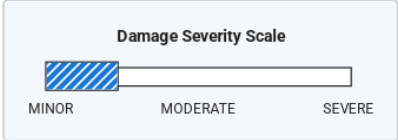
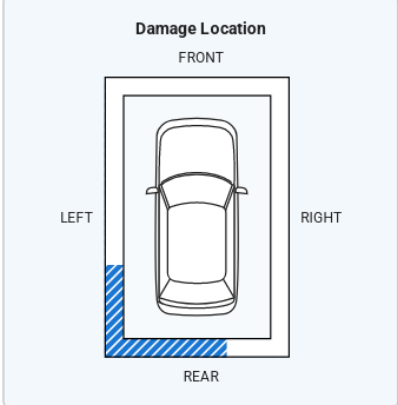
Date	Mileage	Source	Comments
Not Reported		NICB	Vehicle manufactured and shipped to original dealer
07/03/2019	12	Jack Daniels Audi of Paramus Paramus, NJ 201-252-1500 jackdanielsparamusaudi.com/ ★ 4.5 / 5.0 858 Verified Reviews ✓ ❤️ 3,775 Customer Favorites	 Vehicle serviced - Pre-delivery inspection completed
11/11/2019		New Jersey Motor Vehicle Dept. Paramus, NJ Title #GD20193150501	Title issued or updated - Registration issued or renewed - First owner reported - Vehicle color noted as Blue
12/06/2019		Damage Report	 Damage reported: minor damage  - Damage to rear - Damage to left rear
<div style="display: flex; align-items: center;"> <div style="flex: 1;"> <p>CARFAX HAS THE MOST ACCIDENT & DAMAGE INFORMATION</p>  </div> <div style="flex: 2;"> <p>Damage Severity Scale</p>  <p>Damage Location</p>  </div> </div>			

12/13/2019 100 Jack Daniels Audi of Paramus
Paramus, NJ
201-252-1500
jackdanielsparamusaudi.com/
★ 4.5 / 5.0 [858 Verified Reviews](#) ✓

 **Vehicle serviced**

★ 4.5 / 5.0 [858 Verified Reviews](#) ✓
♥ 3,775 Customer Favorites

01/02/2020 1,478

Jack Daniels Audi of Paramus
Paramus, NJ
201-252-1500
jackdanielsparamusaudi.com/



Vehicle serviced

★ 4.5 / 5.0 [858 Verified Reviews](#) ✓
♥ 3,775 Customer Favorites

01/13/2020

Jack Daniels Audi of Paramus
Paramus, NJ
201-252-1500
jackdanielsparamusaudi.com/



Vehicle serviced

- Maintenance inspection completed

★ 4.5 / 5.0 [858 Verified Reviews](#) ✓
♥ 3,775 Customer Favorites

03/12/2020

Damage Report



Accident reported: minor damage with another motor vehicle ⓘ

- Damage to front
- Damage to right front

**CARFAX HAS THE MOST
ACCIDENT & DAMAGE
INFORMATION**

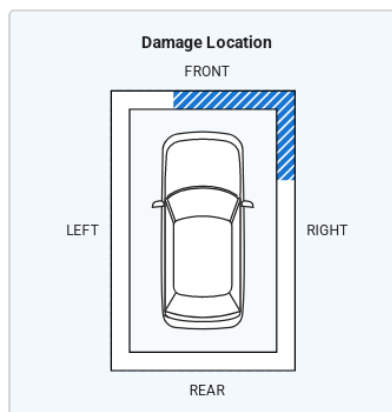
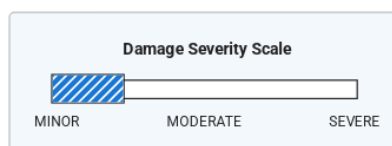

05/05/2020 5,307

Jack Daniels Audi of Paramus
Paramus, NJ
201-252-1500
jackdanielsparamusaudi.com/



Vehicle serviced

- Maintenance inspection completed

★ 4.5 / 5.0 [858 Verified Reviews](#) ✓
♥ 3,775 Customer Favorites

05/17/2020 5,337

Jack Daniels Audi of Paramus
Paramus, NJ

Vehicle offered for sale

★ 4.5 / 5.0 [858 Verified Reviews](#) ✓
♥ 3,775 Customer Favorites

05/21/2020 5,340

Jack Daniels Audi of Paramus
Paramus, NJ
201-252-1500
jackdanielsparamusaudi.com/



Vehicle serviced

- Pre-delivery inspection completed
- 10,000 mile service performed
- Brakes checked
- Wiper(s) replaced

★ 4.5 / 5.0 [858 Verified Reviews](#) ✓
♥ 3,775 Customer Favorites



Looks like this dealer serviced the car in order to prepare it for sale. That's a good thing!

06/03/2020

Audi Certified Dealer
Paramus, NJ

Sold as an Audi Certified pre-owned vehicle

[Visit the website of - Audi](#)

[Visit the website of - Audi Certified Pre-Owned Program](#)

06/22/2020		New York Motor Vehicle Dept. Larchmont, NY	Registration issued or renewed - Titled or registered as personal lease vehicle - Passed safety inspection
06/30/2020	6,120	New York Inspection Station	Passed safety inspection - Emissions inspection performed





Owner 2 Purchased: 2020	Personal Vehicle 8,678 mi/yr
-----------------------------------	---------------------------------

Date	Mileage	Source	Comments
07/07/2020		New York Motor Vehicle Dept. Larchmont, NY	Title issued or updated - New owner reported - Loan or lien reported
03/04/2021		New York Motor Vehicle Dept. Larchmont, NY	Registration issued or renewed - Titled or registered as personal vehicle - Passed safety inspection
07/13/2021	17,130	Giacomo Service II Larchmont, NY 914-834-8006 giacomoautorepair.com/ ★ 5.0 / 5.0 20 Verified Reviews ✓ ❤️ 1 Customer Favorite	Vehicle serviced - Emissions or safety inspection performed
07/14/2021		Giacomo Service Station I Larchmont, NY 914-834-1258	Vehicle serviced - Emissions or safety inspection performed
07/14/2021		New York Inspection Station	Passed safety inspection - Passed emissions inspection
09/22/2021	18,516	Audi Queens Flushing, NY 929-297-0700 audiqueens.com ★ 4.6 / 5.0 185 Verified Reviews ✓ ❤️ 14 Customer Favorites	Vehicle serviced - Maintenance inspection completed - 20,000 mile service performed - Anti-theft/keyless remote battery replaced - Body lubricated - Brakes checked - Brake fluid flushed/changed - Cabin air filter replaced/cleaned - Cooling system checked - CV boot(s) checked - Drivability/performance checked - Fluids checked - Fuel injection system flushed/serviced - Fuel system cleaned/serviced - Headlights adjusted - Horns checked - Instrument cluster checked - Lights checked - Maintenance reminder reset - Oil and filter changed - Paint sealant/protection checked - Seatbelts checked - Steering/suspension checked - Sunroof checked - Tire condition and pressure checked - Undercoating/rustproofing inspected - Wipers/washers checked
11/23/2021		Audi	Manufacturer Compliance Recall issued - NHTSA #21V874 - Recall #74E3 PASSENGER OCCUPANT DETECTION SYSTEM (PODS) - Status: Remedy Available





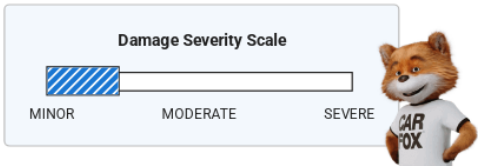



- Status: Remedy Available

Locate an authorized [Audi dealer](#) to obtain more information about this recall

[+ Learn more about this recall](#)

06/27/2022		Damage Report	 Damage reported: minor damage 
<div data-bbox="847 286 1326 450"></div>			
10/06/2022	27,412	New York Inspection Station	Passed safety inspection - Passed emissions inspection
01/01/2023	29,898	Audi New Rochelle New Rochelle, NY 914-779-2020 audinewrochelle.com/ ★ 4.8 / 5.0 273 Verified Reviews  ♥ 167 Customer Favorites	Vehicle offered for sale
01/02/2023	29,961	Auto Auction	Vehicle sold - Listed as a dealer vehicle

 Owner 3 Purchased: 2023	Personal Vehicle 20,117 mi/yr
--	----------------------------------

Date	Mileage	Source	Comments
04/20/2023	30,111	Texas Motor Vehicle Dept. Denton, TX Title #06130945026103903	Title issued or updated - New owner reported - Loan or lien reported - Vehicle color noted as Blue
08/15/2023	43,652	Anything Automotive Denton, TX 940-383-0600 https://facebook.com/anythingautomotivetexas/ ★ 5.0 / 5.0 65 Verified Reviews  ♥ 5 Customer Favorites	 Vehicle serviced - Brakes checked - Cabin air filter checked - Cabin air filter replaced/cleaned - Oil and filter changed - Transmission fluid changed
10/23/2023	48,676	Anything Automotive Denton, TX 940-383-0600 https://facebook.com/anythingautomotivetexas/ ★ 5.0 / 5.0 65 Verified Reviews  ♥ 5 Customer Favorites	 Vehicle serviced - Oil and filter changed
12/13/2023	51,879	Anything Automotive Denton, TX 940-383-0600 https://facebook.com/anythingautomotivetexas/ ★ 5.0 / 5.0 65 Verified Reviews  ♥ 5 Customer Favorites	 Vehicle serviced - Engine mount(s) replaced - Spark plug(s) replaced
03/26/2024	58,917	European Service Center Dallas, TX 469-369-0743 europeanservicecenter.com/ ★ 4.9 / 5.0 43 Verified Reviews  ♥ 4 Customer Favorites	 Vehicle serviced - Brakes checked - Engine oil/fluid leak checked - Exhaust system checked - Fluids checked - Oil and filter changed - Steering/suspension checked

★ 4.9 / 5.0 43 Verified Reviews ✓
♥ 4 Customer Favorites

- Fluids checked
- Oil and filter changed
- Steering/suspension checked
- Tire condition and pressure checked

05/13/2024 61,751

Brakes Plus
The Colony, TX
469-850-4201
<https://brakesplus.com>

★ 4.8 / 5.0 173 Verified Reviews ✓
♥ 5 Customer Favorites



- Vehicle serviced**
- Brake fluid flushed/changed
 - Front brakes serviced
 - Emissions inspection performed
 - Rear brakes serviced/adjusted
 - Safety inspection performed

05/13/2024

Texas
Inspection Station
Denton, TX

Passed emissions inspection

10/27/2024

70,558

Valvoline Instant Oil Change
Lewisville, TX
972-791-8912
vioc.com

★ 4.6 / 5.0 132 Verified Reviews ✓
♥ 1 Customer Favorite



- Vehicle serviced**
- Oil and filter changed

03/17/2025

Damage Report



Accident reported: minor damage ⓘ

- Damage to front
- Damage to undercarriage
- Damage to rear
- Damage to right rear

CARFAX HAS THE MOST ACCIDENT & DAMAGE INFORMATION

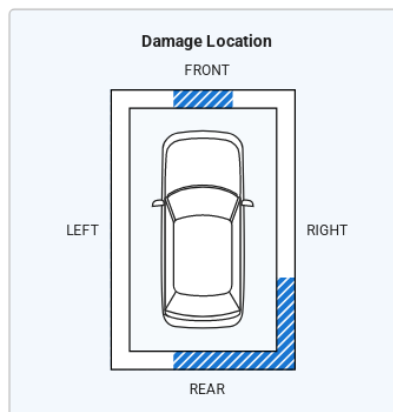
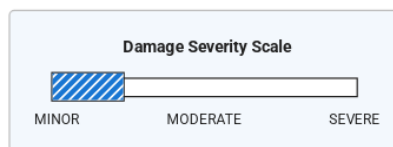

05/28/2025

Texas
Motor Vehicle Dept.
Denton, TX
Title #28695345802008709

Title issued or updated
- Loan or lien released
- Vehicle color noted as Blue

09/16/2025

Damage Report



TOTAL LOSS VEHICLE



There are many reasons an insurance company will declare a vehicle a total loss. Have this vehicle inspected by a qualified technician before you buy. [Learn More](#)

09/16/2025

78,614

Oklahoma
Motor Vehicle Dept.
Livingston, LA
Title #810016745663

Title or registration issued to insurance company

09/29/2025

Audi

Connect Service available with subscription

Connect offers services to enhance navigation, infotainment, and peace of mind

[Learn more](#)

Have Questions? Consumers, please visit our Help Center at www.carfax.com. Dealers or Subscribers, please visit our Help Center at www.carfaxonline.com.

Accident Indicator

CARFAX receives information about accidents in all 50 states, the District of Columbia and Canada.

Not every accident is reported to CARFAX. As details about the accident become available, those additional details are added to the CARFAX Vehicle History Report. CARFAX recommends that you have this vehicle inspected by a qualified mechanic.

- According to the National Safety Council, Injury Facts, 2021 edition, 5% of the 276 million registered vehicles in the U.S. were involved in an accident in 2019. Over 77% of these were considered minor or moderate.
- This CARFAX Vehicle History Report is based only on information supplied to CARFAX and available as of 9/29/25 at 2:34:18 PM (CDT). Other information about this vehicle, including problems, may not have been reported to CARFAX. Use this report as one important tool, along with a vehicle inspection and test drive, to make a better decision about your next used car.

Damage Indicator

Damage can be a result of many different types of events. Examples include contact with objects (other cars, trees, traffic signs, road debris, etc), vandalism, or weather-related events. Not every damage event is reported to CARFAX. As details about the damage event become available, those additional details are added to the CARFAX Vehicle History Report. CARFAX recommends that you have this vehicle inspected by a qualified mechanic.

- This CARFAX Vehicle History Report is based only on information supplied to CARFAX and available as of 9/29/25 at 2:34:18 PM (CDT). Other information about this vehicle, including problems, may not have been reported to CARFAX. Use this report as one important tool, along with a vehicle inspection and test drive, to make a better decision about your next used car.

Damage Severity

Damage events result in one of the following severity levels:

- Minor: Generally, minor damage is cosmetic (including dents or scratches), may only require reconditioning, and typically does not compromise a vehicle's operation and/or safety.
- Moderate: Moderate damage may affect multiple components of the vehicle and may impair the vehicle's operation and/or safety.
- Severe: Severe damage usually affects multiple components of the vehicle and is likely to compromise the vehicle's operation and/or safety.

CARFAX recommends getting a pre-purchase inspection at a certified collision repair facility.

First Owner

When the first owner(s) obtains a title from a Department of Motor Vehicles as proof of ownership.

Manufacturer Recall

Automobile manufacturers issue recall notices to inform vehicle owners of a safety defect or failure to meet minimum federal safety or emissions standards. Manufacturer recalls are repaired at no cost to the customer.

New Owner Reported

When a vehicle is sold to a new owner, the Title must be transferred to the new owner(s) at a Department of Motor Vehicles.

Ownership History



CARFAX defines an owner as an individual or business that possesses and uses a vehicle. Not all title transactions represent changes in ownership. To provide estimated number of owners, CARFAX proprietary technology analyzes all the events in a vehicle history. Estimated ownership is available for vehicles manufactured after 1991 and titled solely in the US including Puerto Rico. Dealers sometimes opt to take ownership of a vehicle and are required to in the following states: Maine, Massachusetts, New Jersey, Ohio, Oklahoma, Pennsylvania and South Dakota. Please consider this as you review a vehicle's estimated ownership history.

Title Issued

A state issues a title to provide a vehicle owner with proof of ownership. Each title has a unique number. Each title or registration record on a CARFAX report does not necessarily indicate a change in ownership. In Canada, a registration and bill of sale are used as proof of ownership.

Total Loss Vehicle

An insurance or fleet company declares a vehicle a total loss when a claim exceeds approximately 75% of its pre-damage value or if the vehicle is stolen and not recovered. This damage threshold varies by company. These companies typically take possession and obtain the title. Not all total loss vehicles result in a DMV-reported branded title. This may occur when an insurance company's definition of a total loss is different than the state DMV's definition for a branded title or when the owner of the vehicle is a self-insured company, like a fleet or rental company.

Follow Us:  facebook.com/CARFAX  [@CARFAXinc](https://twitter.com/CARFAXinc)  [About CARFAX](#)

CARFAX DEPENDS ON ITS SOURCES FOR THE ACCURACY AND RELIABILITY OF ITS INFORMATION. THEREFORE, NO RESPONSIBILITY IS ASSUMED BY CARFAX OR ITS AGENTS FOR ERRORS OR OMISSIONS IN THIS REPORT. CARFAX FURTHER EXPRESSLY DISCLAIMS ALL WARRANTIES, EXPRESS OR IMPLIED, INCLUDING ANY IMPLIED WARRANTIES OF MERCHANTABILITY OR FITNESS FOR A PARTICULAR PURPOSE.

I have reviewed and received a copy of the CARFAX Vehicle History Report for this 2019 AUDI A5 SPORTBACK vehicle (VIN: WAUENCF53KA029708), which is based on information supplied to CARFAX and available as of 9/29/25 at 3:34 PM (EDT).

Customer Signature

Date

Dealer Signature

Date