

2018 BMW I3 Base W/ Range Extender

70,422 mi | VIN: WBY7Z4C56JVD95553

Vehicle Details

CARFAX HAS THE MOST ACCIDENT & DAMAGE INFORMATION



BRANDED TITLE

Salvage

CARFAX VALUE \$7,520

Update Trim & Options

15 Service history records

2 Previous owners

Types of owners: Personal lease, Personal

Last owned in Pennsylvania

32 Detailed records available

This CARFAX Vehicle History Report is based only on information supplied to CARFAX and available as of 4/15/26 at 5:27:38 AM (CDT). Other information about this vehicle, including problems, may not have been reported to CARFAX. Use this report as one important tool, along with a vehicle inspection and test drive, to make a better decision about your next used car.

CARFAX Accident / Damage History

Not all accidents / issues are reported to CARFAX

Event 1

01/26/2019

Accident reported: minor damage with another motor vehicle

View More Details

Damage Severity Scale



Minor

Moderate

Severe

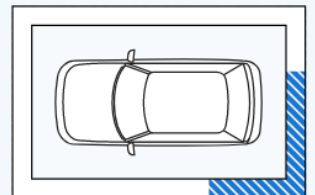

Event 2

02/03/2026

TOTAL LOSS VEHICLE

- Accident reported
- Vehicle declared a total loss by an insurance company
- Vehicle damaged in multiple places

[View More Details >](#)

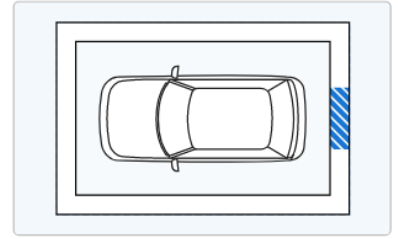

Event 3

02/05/2026

Damage reported: minor damage ⓘ

[View More Details >](#)

Damage Severity Scale

Minor Moderate Severe

CARFAX History-Based Value Report

\$7,520

CARFAX Retail Value

History events affecting this vehicle's value

- ↑ ⚙️ Service History
- ↑ 🏠 Personal Vehicle
- ↓ ⚠️ Salvage Brand

CARFAX Additional History

Not all accidents / issues are reported to CARFAX



	👤 Owner 1	👤 Owner 2
Total Loss ⓘ Total Loss Reported: 02/03/2026.	<input checked="" type="checkbox"/>	Total Loss Reported
Structural Damage ⓘ CARFAX recommends that you have this vehicle inspected by a collision repair specialist.	<input checked="" type="checkbox"/>	<input checked="" type="checkbox"/>
Airbag Deployment ⓘ No airbag deployment reported to CARFAX.	<input checked="" type="checkbox"/>	<input checked="" type="checkbox"/>
Odometer Check ⓘ No indication of an odometer rollback.	<input checked="" type="checkbox"/>	<input checked="" type="checkbox"/>
Accident / Damage ⓘ DMV title problems reported. Accidents reported: 01/26/2019 and 02/03/2026	Accident Reported	Severe Damage

Accident / Damage ⓘ DMV title problems reported. Accidents reported: 01/26/2019 and 02/03/2026. Damage reported: 02/05/2026.	Accident Reported	Severe Damage
Manufacturer Recall ⓘ No open recalls reported to CARFAX.	No Recalls Reported	No Recalls Reported
Basic Warranty ⓘ Original manufacturer warranty likely voided by manufacturer.	✓	Warranty Voided

CARFAX Title History	Owner 1	Owner 2
Damage Brands ⓘ Salvage Junk Rebuilt Fire Flood Hail Lemon	No Problem	Alert! Problem Found
Odometer Brands ⓘ Not Actual Mileage Exceeds Mechanical Limits	No Problem	No Problem
 ALERT! - Severe problems were reported by a state Department of Motor Vehicles (DMV). This vehicle does not qualify for the CARFAX Buyback Guarantee.		

CARFAX Ownership History <small>The number of owners is estimated</small>	Owner 1	Owner 2
Year purchased	2018	2021
Type of owner	Personal lease	Personal
Estimated length of ownership	3 yrs. 1 mo.	4 yrs. 9 mo.
Owned in the following states/provinces	New York, Pennsylvania	Pennsylvania
Estimated miles driven per year	8,691/yr	9,023/yr
Last reported odometer reading	26,764	70,422

CARFAX Detailed History [Glossary](#)

 Owner 1 Purchased: 2018		Personal Lease Vehicle 8,691 mi/yr	
Date	Mileage	Source	Comments
03/06/2018	5	Rallye BMW Westbury, NY 516-393-0000 rallyebmw.com  17,566 Customer Favorites	Vehicle offered for sale
03/07/2018	6	New York Inspection Station	Passed safety inspection -Emissions inspection performed
03/08/2018		Rallye BMW Westbury, NY 516-393-0000 rallyebmw.com  17,566 Customer Favorites	Vehicle serviced -Pre-delivery inspection completed -Brakes checked -Safety inspection performed -Vehicle washed/detailed

♥ 17,566 Customer Favorites

- Vehicle washed/detailed

03/23/2018

10



Rallye BMW
Westbury, NY
516-393-0000
rallyebmw.com

♥ 17,566 Customer Favorites

Vehicle serviced

- Pre-delivery inspection completed
- Floor mats installed
- Vehicle washed/detailed

04/02/2018

New York
Motor Vehicle Dept.
Manhasset, NY

Registration issued or renewed

- Titled or registered as personal lease vehicle
- Passed safety inspection

04/16/2018

New York
Motor Vehicle Dept.
Hilliard, OH

Title issued or updated

- First owner reported
- Titled or registered as personal lease vehicle



Two states? Vehicle leasing companies often title a car in one state but register it to be driven in another.

01/26/2019

Damage Report

Accident reported: minor damage with another motor vehicle ⓘ

- Damage to left rear
- Damage to rear

CARFAX HAS THE MOST ACCIDENT & DAMAGE INFORMATION

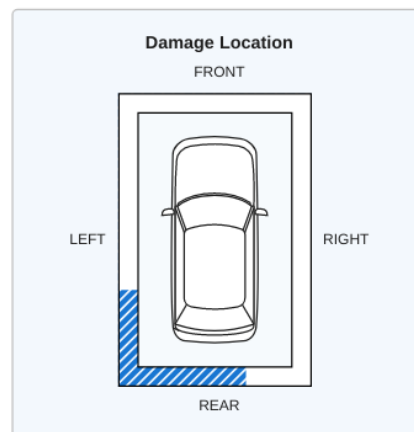
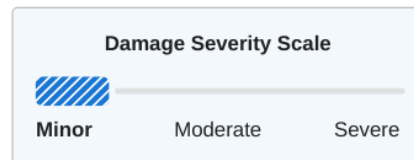

03/27/2019

9,345



Rallye BMW
Westbury, NY
516-393-0000
rallyebmw.com

♥ 17,566 Customer Favorites

Vehicle serviced

- Battery charged
- Computer(s) checked
- Computer reprogrammed

03/30/2019

9,363

New York
Inspection Station

Passed safety inspection

- Emissions inspection performed

04/03/2019



Rallye Motors
Roslyn, NY
516-625-1600
rallyemotors.com/

♥ 18,588 Customer Favorites

Vehicle serviced

04/30/2019

New York
Motor Vehicle Dept.
Manhasset, NY

Registration issued or renewed

- Titled or registered as personal lease vehicle
- Passed safety inspection

05/02/2019

10,396







Rallye BMW
Westbury, NY
516-393-0000
rallyebmw.com

♥ 17,566 Customer Favorites



Vehicle serviced

- Recommended maintenance performed
- Four wheel alignment performed
- Oil and filter changed

♥ 17,566 Customer Favorites

10/03/2019 	14,886	Rallye BMW Westbury, NY 516-393-0000 rallyebmw.com ♥ 17,566 Customer Favorites	Vehicle serviced -Maintenance inspection completed -Recommended maintenance performed -Brake fluid flushed/changed -Fluids checked
01/21/2020 	17,783	Rallye BMW Westbury, NY 516-393-0000 rallyebmw.com ♥ 17,566 Customer Favorites	Vehicle serviced -Maintenance inspection completed -Recommended maintenance performed
08/07/2020	22,226	New York Inspection Station	Passed safety inspection -Passed emissions inspection
08/10/2020 	22,232	Rallye BMW Westbury, NY 516-393-0000 rallyebmw.com ♥ 17,566 Customer Favorites	Vehicle serviced -Recommended maintenance performed -Cabin air filter replaced/cleaned -Four wheel alignment performed -Front brake rotor(s) resurfaced -Oil and filter changed -Tire(s) replaced
04/26/2021	26,594	Pennsylvania Motor Vehicle Dept. Conshohocken, PA Title #8322688801 CO	Title issued or updated -Dealer took title of this vehicle while it was in inventory
04/28/2021 	26,723	BMW of Fort Washington Fort Washington, PA 215-643-3322 bmwoffortwashington.com/ ♥ 1,326 Customer Favorites	Vehicle serviced -Battery charged
04/30/2021	26,764	Inspection Station	Passed emissions inspection
05/18/2021 		Rallye BMW Westbury, NY 516-393-0000 rallyebmw.com ♥ 17,566 Customer Favorites	Vehicle serviced

 Owner 2 Purchased: 2021	Personal Vehicle 9,023 mi/yr
--	---------------------------------

Date	Mileage	Source	Comments
05/24/2021	26,811	Pennsylvania Motor Vehicle Dept.	Vehicle purchase reported
06/08/2021		Pennsylvania Motor Vehicle Dept. Pottstown, PA Title #8322688802 RO	Title issued or updated -New owner reported -Loan or lien reported
06/30/2021 	28,427	BMW of Brooklyn Brooklyn, NY 718-759-5940 bmwofbrooklyn.com ♥ 157 Customer Favorites	Vehicle serviced -Electrical system checked -Fluids checked -Tire condition and pressure checked -Tire(s) replaced
11/20/2021 	34,139	BMW of Devon Devon, PA 610-687-9350 bmwofdevon.com ♥ 1,938 Customer Favorites	Vehicle serviced -Maintenance inspection completed -Wheels checked

♥ 1,938 Customer Favorites

12/17/2021

Pennsylvania
Motor Vehicle Dept.
Pottstown, PA
Title #8322688802 RO

Title issued or updated

-Registration updated when owner moved the vehicle to a new location

02/07/2022



Meyers Automotive
Pottstown, PA
610-323-6842
<https://meyersautomotivepa.com/>

Vehicle serviced

-Battery/charging system checked
-Battery replaced
-Four wheel alignment performed
-Front strut(s) replaced
-Strut(s) replaced
-Tire condition and pressure checked
-Tire(s) replaced
-Two tires balanced
-Two tires mounted

04/29/2024



58,160

Orange County BMW
Harriman, NY
845-782-4269
orangecountybmw.com/
♥ 632 Customer Favorites

Vehicle serviced

-Maintenance inspection completed
-Battery/charging system checked
-Transmission checked

12/18/2024



58,164

Orange County BMW
Harriman, NY
845-782-4269
orangecountybmw.com/
♥ 632 Customer Favorites

Vehicle serviced

-Maintenance inspection completed
-Battery/charging system checked
-Battery replaced
-Control arm(s) replaced
-Lower control arm(s) replaced
-One tire balanced
-One tire mounted
-Tire condition and pressure checked
-Tire(s) balanced
-Tire(s) mounted
-Transmission checked

02/03/2026



Damage Report

TOTAL LOSS VEHICLE

-Accident reported
-Vehicle declared a total loss by an insurance company
-Damage to rear
-Vehicle damaged in multiple places

CARFAX HAS THE MOST ACCIDENT & DAMAGE INFORMATION

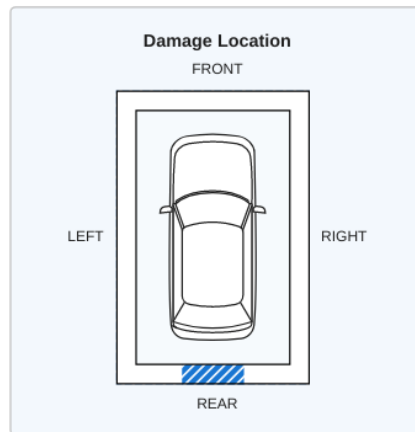

There are many reasons an insurance company will declare a vehicle a total loss. Have this vehicle inspected by a qualified technician before you buy. [Learn More](#)

02/05/2026

Damage Report

Damage reported: minor damage ⓘ

-Damage to rear
-Damage to right rear

Damage Severity Scale



Minor

Moderate

Severe



CARFAX HAS THE MOST ACCIDENT & DAMAGE INFORMATION



Minor Moderate Severe

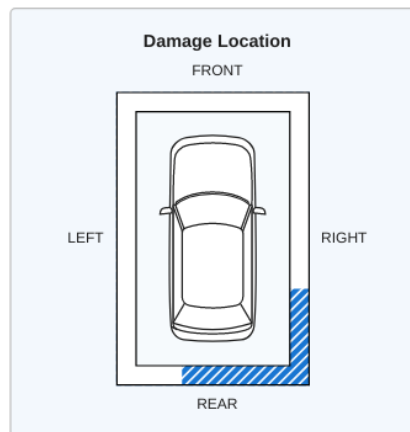

03/23/2026		Pennsylvania Motor Vehicle Dept.	Title or registration issued to insurance company
03/23/2026	70,422	Pennsylvania Motor Vehicle Dept. Camp Hill, PA Title #832268802 GE	SALVAGE TITLE/CERTIFICATE ISSUED

Have Questions? Consumers, please visit our Help Center at www.carfax.com. Dealers or Subscribers, please visit our Help Center at www.carfaxonline.com.

Accident Indicator

CARFAX receives information about accidents in all 50 states, the District of Columbia and Canada.

Not every accident is reported to CARFAX. As details about the accident become available, those additional details are added to the CARFAX Vehicle History Report. CARFAX recommends that you have this vehicle inspected by a qualified mechanic.

- According to the National Safety Council, Injury Facts, 2021 edition, 5% of the 276 million registered vehicles in the U.S. were involved in an accident in 2019. Over 77% of these were considered minor or moderate.
- This CARFAX Vehicle History Report is based only on information supplied to CARFAX and available as of 4/15/26 at 5:27:38 AM (CDT). Other information about this vehicle, including problems, may not have been reported to CARFAX. Use this report as one important tool, along with a vehicle inspection and test drive, to make a better decision about your next used car.

Damage Indicator

Damage can be a result of many different types of events. Examples include contact with objects (other cars, trees, traffic signs, road debris, etc), vandalism, or weather-related events. Not every damage event is reported to CARFAX. As details about the damage event become available, those additional details are added to the CARFAX Vehicle History Report. CARFAX recommends that you have this vehicle inspected by a qualified mechanic.

- This CARFAX Vehicle History Report is based only on information supplied to CARFAX and available as of 4/15/26 at 5:27:38 AM (CDT). Other information about this vehicle, including problems, may not have been reported to CARFAX. Use this report as one important tool, along with a vehicle inspection and test drive, to make a better decision about your next used car.

Damage Severity

Damage events result in one of the following severity levels:

- Minor: Generally, minor damage is cosmetic (including dents or scratches), may only require reconditioning, and typically does not compromise a vehicle's operation and/or safety.
- Moderate: Moderate damage may affect multiple components of the vehicle and may impair the vehicle's operation and/or safety.
- Severe: Severe damage usually affects multiple components of the vehicle and is likely to compromise the vehicle's operation and/or safety.

CARFAX recommends getting a pre-purchase inspection at a certified collision repair facility.

First Owner

When the first owner(s) obtains a title from a Department of Motor Vehicles as proof of ownership.

New Owner Reported

When a vehicle is sold to a new owner, the Title must be transferred to the new owner(s) at a Department of Motor Vehicles.

Ownership History

CARFAX defines an owner as an individual or business that possesses and uses a vehicle. Not all title transactions represent changes in ownership. To provide estimated number of owners, CARFAX proprietary technology analyzes all the events in a vehicle history. Estimated ownership is available for vehicles

CARFAX defines an owner as an individual or business that possesses and uses a vehicle. Not all title transactions represent changes in ownership. To provide estimated number of owners, CARFAX proprietary technology analyzes all the events in a vehicle history. Estimated ownership is available for vehicles manufactured after 1991 and titled solely in the US including Puerto Rico. Dealers sometimes opt to take ownership of a vehicle and are required to in the following states: Maine, Massachusetts, New Jersey, Ohio, Oklahoma, Pennsylvania and South Dakota. Please consider this as you review a vehicle's estimated ownership history.

Salvage Title

A Salvage Title is issued on a vehicle damaged to the extent that the cost of repairing the vehicle exceeds approximately 75% of its pre-damage value. This damage threshold may vary by state. Some states treat Junk titles the same as Salvage but the majority use this title to indicate that a vehicle is not road worthy and cannot be titled again in that state. The following eleven states also use Salvage titles to identify stolen vehicles - AZ, FL, GA, IL, MD, MN, NJ, NM, NY, OK and OR.

Title Issued

A state issues a title to provide a vehicle owner with proof of ownership. Each title has a unique number. Each title or registration record on a CARFAX report does not necessarily indicate a change in ownership. In Canada, a registration and bill of sale are used as proof of ownership.

Total Loss Vehicle

An insurance or fleet company declares a vehicle a total loss when a claim exceeds approximately 75% of its pre-damage value or if the vehicle is stolen and not recovered. This damage threshold varies by company. These companies typically take possession and obtain the title. Not all total loss vehicles result in a DMV-reported branded title. This may occur when an insurance company's definition of a total loss is different than the state DMV's definition for a branded title or when the owner of the vehicle is a self-insured company, like a fleet or rental company.

[Full Glossary](#)

Follow
Us:



facebook.com/CARFAX



[@CARFAXinc](https://twitter.com/CARFAXinc)



[About CARFAX](#)

CARFAX DEPENDS ON ITS SOURCES FOR THE ACCURACY AND RELIABILITY OF ITS INFORMATION. THEREFORE, NO RESPONSIBILITY IS ASSUMED BY CARFAX OR ITS AGENTS FOR ERRORS OR OMISSIONS IN THIS REPORT. CARFAX FURTHER EXPRESSLY DISCLAIMS ALL WARRANTIES, EXPRESS OR IMPLIED, INCLUDING ANY IMPLIED WARRANTIES OF MERCHANTABILITY OR FITNESS FOR A PARTICULAR PURPOSE.

© 2026 CARFAX, Inc., part of S&P Global. All rights reserved.
4/15/26 5:27:38 AM (CDT)

I have reviewed and received a copy of the CARFAX Vehicle History Report for this 2018 BMW I3 vehicle (VIN: WBY7Z4C56JVD95553), which is based on information supplied to CARFAX and available as of 4/15/26 at 6:27 AM (EDT).

Customer Signature

Date

Dealer Signature

Date