

2018 Volvo V60 T5 Dynamic

74,237 mi | VIN: YV140MEL5J2384966

[Vehicle Details](#) ▾

CARFAX HAS THE MOST ACCIDENT & DAMAGE INFORMATION



BRANDED TITLE



Salvage

CARFAX VALUE \$13,260

[Update Trim & Options](#)



24 Service history records



3 Previous owners



Types of owners: Personal lease, Personal



Last owned in California



40 Detailed records available

This CARFAX Vehicle History Report is based only on [information](#) supplied to CARFAX and available as of 3/29/26 at 10:08:41 AM (CDT). Other information about this vehicle, including problems, may not have been reported to CARFAX. Use this report as one important tool, along with a vehicle inspection and test drive, to make a better decision about your next used car.

CARFAX Accident / Damage History

Not all accidents / issues are reported to CARFAX

Event 1

02/11/2020

Damage reported: minor damage ⓘ

[View More Details](#) >

Damage Severity Scale



Minor

Moderate

Severe

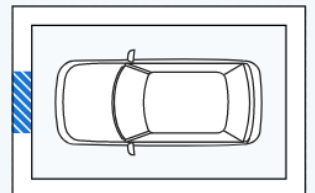

Event 2

02/04/2026

Accident reported: minor damage 

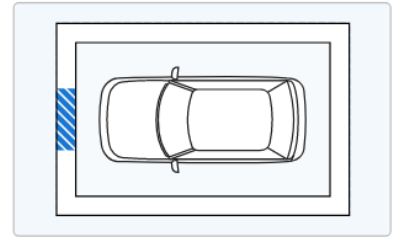
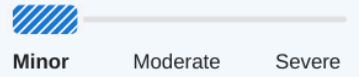

[View More Details >](#)

Damage Severity Scale



CARFAX Recent Service Highlights

Key services performed in the last 12 months









Service	Comments	Date	
 Oil	 Oil and filter changed	08/29/2025	View Details >
 <div style="border: 1px solid #ccc; padding: 5px; display: inline-block;"> This car has been recently serviced. That's a good thing! </div>			

CARFAX History-Based Value Report

\$13,260



















CARFAX Retail Value

History events affecting this vehicle's value

-   Service History
-   Personal Vehicle
-   Prior Certified Pre-Owned
-   Salvage Brand

CARFAX Additional History

Not all accidents / issues are reported to CARFAX

	 Owner 1	 Owner 2	 Owner 3
Total Loss  No total loss reported to CARFAX.			
Structural Damage  CARFAX recommends that you have this vehicle inspected by a collision repair specialist.			
Airbag Deployment  No airbag deployment reported to CARFAX.			
Odometer Check  No indication of an odometer rollback.			

No indication of an odometer rollback.

Accident / Damage ⓘ DMV title problems reported. Damage reported: 02/11/2020. Accident reported: 02/04/2026.	Damage Reported	No New Issues Reported	Severe Damage
Manufacturer Recall ⓘ No open recalls reported to CARFAX.	No Recalls Reported	No Recalls Reported	No Recalls Reported
Basic Warranty ⓘ Original manufacturer warranty likely voided by manufacturer.	✓	✓	Warranty Voided





















CARFAX Title History	Owner 1	Owner 2	Owner 3
Damage Brands ⓘ Salvage Junk Rebuilt Fire Flood Hail Lemon	No Problem	No Problem	Alert! Problem Found
Odometer Brands ⓘ Not Actual Mileage Exceeds Mechanical Limits	No Problem	No Problem	No Problem

ALERT! - Severe problems were reported by a state Department of Motor Vehicles (DMV). This vehicle does not qualify for the CARFAX Buyback Guarantee.

CARFAX Ownership History <small>The number of owners is estimated</small>	Owner 1	Owner 2	Owner 3
Year purchased	2018	2021	2021
Type of owner	Personal lease	Personal	Personal
Estimated length of ownership	2 yrs. 2 mo.	9 months	4 yrs. 3 mo.
Owned in the following states/provinces	California	California	California
Estimated miles driven per year	22,489/yr	---	2,854/yr
Last reported odometer reading	49,999	63,286	74,237

CARFAX Detailed History [Glossary](#)

Owner 1 Purchased: 2018		Personal Lease Vehicle 22,489 mi/yr	
Date	Mileage	Source	Comments
10/07/2017		Volvo Cars of North America, LLC	Vehicle manufactured
11/27/2017		Volvo Motors	Vehicle shipped to original dealer in San Luis Obispo, CA
11/30/2017	5	Smith Volvo San Luis Obispo, CA 805-543-0832 smithvolvo.com 1,153 Customer Favorites	Vehicle offered for sale

12/01/2017 	10	Smith Volvo San Luis Obispo, CA 805-543-0832 smithvolvo.com  1,153 Customer Favorites	Vehicle serviced -Computer(s) checked
08/20/2018 		Smith Volvo San Luis Obispo, CA 805-543-0832 smithvolvo.com  1,153 Customer Favorites	Vehicle serviced -Computer(s) checked -Engine/powertrain computer/module reprogrammed -Radio/sound system repaired
08/31/2018 	155	Smith Volvo San Luis Obispo, CA 805-543-0832 smithvolvo.com  1,153 Customer Favorites	Vehicle serviced -Computer(s) checked -Engine/powertrain computer/module reprogrammed -Radio/sound system repaired
11/26/2018 	333	Smith Volvo San Luis Obispo, CA 805-543-0832 smithvolvo.com  1,153 Customer Favorites	Vehicle serviced -Computer(s) checked -Engine/powertrain computer/module reprogrammed -Radio/sound system repaired
11/29/2018	399	California Motor Vehicle Dept. Paso Robles, CA	Title issued or updated -First owner reported -Titled or registered as personal lease vehicle -Loan or lien reported
02/05/2019		California Motor Vehicle Dept. Paso Robles, CA	Title issued or updated -Loan or lien reported
06/05/2019 	10,199	Smith Volvo San Luis Obispo, CA 805-543-0832 smithvolvo.com  1,153 Customer Favorites	Vehicle serviced -10,000 mile service performed -Tire condition and pressure checked
08/26/2019 	16,446	Niello Volvo of Sacramento Sacramento, CA 916-488-2400 volvo.niello.com/index.htm  4,675 Customer Favorites	Vehicle serviced -Maintenance inspection completed -Tire condition and pressure checked
10/04/2019 	19,892	Smith Volvo San Luis Obispo, CA 805-543-0832 smithvolvo.com  1,153 Customer Favorites	Vehicle serviced -Maintenance inspection completed -20,000 mile service performed -Tire condition and pressure checked
10/16/2019 	20,272	Smith Volvo San Luis Obispo, CA 805-543-0832 smithvolvo.com  1,153 Customer Favorites	Vehicle serviced -Electrical system checked
11/22/2019 	23,558	Smith Volvo San Luis Obispo, CA 805-543-0832 smithvolvo.com  1,153 Customer Favorites	Vehicle serviced -Computer(s) checked -Exhaust manifold gasket replaced
02/05/2020 	29,531	Smith Volvo San Luis Obispo, CA 805-543-0832 smithvolvo.com  1,153 Customer Favorites	Vehicle serviced -30,000 mile service performed

02/11/2020

Damage Report

Damage reported: minor damage ⓘ

-Damage to front

CARFAX HAS THE MOST ACCIDENT & DAMAGE INFORMATION

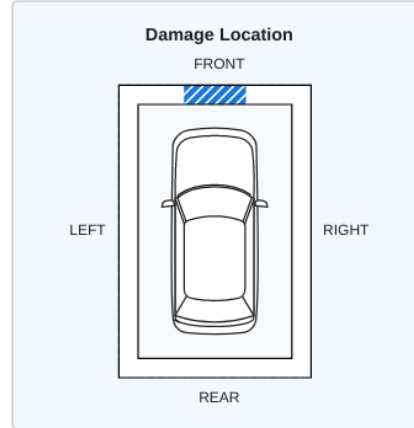
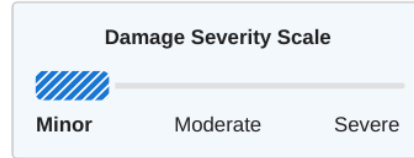

07/30/2020

40,761

Smith Volvo
San Luis Obispo, CA
805-543-0832
smithvolvo.com

Vehicle serviced



♥ 1,153 Customer Favorites

01/06/2021

49,526

Smith Volvo
San Luis Obispo, CA
805-543-0832
smithvolvo.com

Vehicle serviced



-5,000 mile service performed
-Oil and filter changed

♥ 1,153 Customer Favorites

02/10/2021

49,991

Smith Volvo
San Luis Obispo, CA
805-543-0832
smithvolvo.com

Vehicle serviced



-Brakes checked
-Dipstick tube replaced
-Engine checked
-Intake manifold gasket(s) replaced

♥ 1,153 Customer Favorites

02/11/2021

Volvo Certified Retailer
San Luis Obispo, CA

Sold as a Volvo Certified Pre-Owned vehicle



02/11/2021

49,999

Vehicle Manufacturer

Lease vehicle returned to dealer











Owner 2







Purchased: 2021

Personal Vehicle

Date	Mileage	Source	Comments
03/12/2021	50,002	California Motor Vehicle Dept. Atascadero, CA	Title issued or updated -New owner reported -Loan or lien reported
04/09/2021	55,229	American West Tire Pro's Atascadero, CA 805-466-5990 americanwesttire.com ♥ 68 Customer Favorites	Vehicle serviced -Oil and filter changed -Tire condition and pressure checked -Tires rotated

07/27/2021 	60,287	Smith Volvo San Luis Obispo, CA 805-543-0832 smithvolvo.com  1,153 Customer Favorites	Vehicle serviced -Oil and filter changed
10/13/2021 	63,090	Sunset Honda San Luis Obispo, CA 805-544-9500 sunsethonda.com  6,960 Customer Favorites	Vehicle serviced
10/25/2021 	63,161	Smith Volvo San Luis Obispo, CA 805-543-0832 smithvolvo.com  1,153 Customer Favorites	Vehicle serviced -Power steering checked
10/25/2021		California Motor Vehicle Dept. Atascadero, CA	Title issued or updated -Loan or lien reported
11/02/2021 		Wrona's Quality Auto Repair San Luis Obispo, CA 805-543-3180 wronas.com/  26 Customer Favorites	Vehicle serviced -Maintenance inspection completed -Brakes checked -Drivability/performance checked -Oil and filter changed -Rear brake pads replaced -Rear brake rotor(s) replaced -Safety inspection performed -Tire condition and pressure checked
11/23/2021	63,286	Online Listing	Vehicle offered for sale

 Owner 3 Purchased: 2021	Personal Vehicle 2,854 mi/yr
---	---------------------------------

Date	Mileage	Source	Comments
12/21/2021	63,703	California Motor Vehicle Dept. San Luis Obispo, CA	Odometer reading reported
01/13/2022		California Motor Vehicle Dept. San Luis Obispo, CA	Title issued or updated -New owner reported
11/15/2022 	65,605	Smith Volvo San Luis Obispo, CA 805-543-0832 smithvolvo.com  1,153 Customer Favorites	Vehicle serviced -60,000 mile service performed -Air filter replaced -Cabin air filter replaced/cleaned -Fluids checked -Oil and filter changed -Power steering checked -Spark plug(s) replaced -Tires rotated
12/01/2022 	65,738	Smith Volvo San Luis Obispo, CA 805-543-0832 smithvolvo.com  1,153 Customer Favorites	Vehicle serviced
10/31/2023 	69,083	Wrona's Quality Auto Repair San Luis Obispo, CA 805-543-3180 wronas.com/  26 Customer Favorites	Vehicle serviced -Maintenance inspection completed -Drain plug gasket replaced -Front wiper blades/refills replaced -Lights checked -Oil and filter changed

wronas.com/
♥ 26 Customer Favorites

- Front wiper blades/reinfs replaced
- Lights checked
- Oil and filter changed
- Tire condition and pressure checked
- Tires rotated
- Wiper(s) replaced

12/01/2023 69,444
🔧

Smith Volvo
San Luis Obispo, CA
805-543-0832
smithvolvo.com
♥ 1,153 Customer Favorites

Vehicle serviced

11/14/2024 72,717
🔧

Wrona's Quality Auto Repair
San Luis Obispo, CA
805-543-3180
wronas.com/
♥ 26 Customer Favorites

- Vehicle serviced**
- Maintenance inspection completed
 - Maintenance reminder reset
 - Oil and filter changed
 - Tire condition and pressure checked
 - Tires rotated

08/29/2025 74,237
🔧

Morin Brothers Automotive
San Luis Obispo, CA
805-541-2407
morinbros.com/slo/
♥ 1,462 Customer Favorites

- Vehicle serviced**
- Maintenance inspection completed
 - Brakes checked
 - Fluids checked
 - Oil and filter changed

02/04/2026

Damage Report

Accident reported: minor damage ⓘ
-Damage to front

CARFAX HAS THE MOST ACCIDENT & DAMAGE INFORMATION

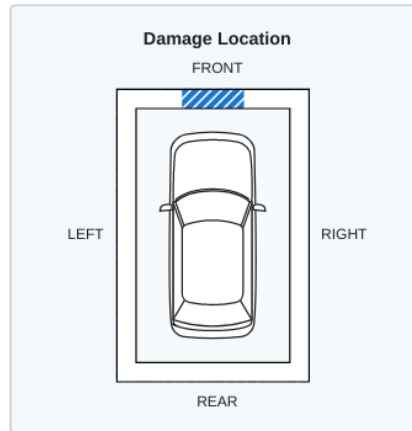
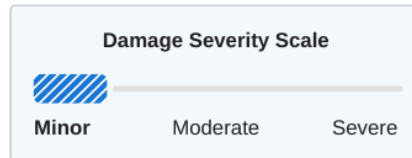

03/13/2026

California
Motor Vehicle Dept.
San Luis Obispo, CA

Title issued or updated
-Duplicate title issued

03/25/2026

Damage Report

SALVAGE TITLE/CERTIFICATE ISSUED



Have Questions? Consumers, please visit our Help Center at www.carfax.com. Dealers or Subscribers, please visit our Help Center at www.carfaxonline.com.

Accident Indicator

CARFAX receives information about accidents in all 50 states, the District of Columbia and Canada.

Not every accident is reported to CARFAX. As details about the accident become available, those additional details are added to the CARFAX Vehicle History Report. CARFAX recommends that you have this vehicle inspected by a qualified mechanic.

- According to the National Safety Council. Injury Facts. 2021 edition. 5% of the 276 million registered vehicles in the U.S. were involved in an

Report. CARFAX recommends that you have this vehicle inspected by a qualified mechanic.

- According to the National Safety Council, Injury Facts, 2021 edition, 5% of the 276 million registered vehicles in the U.S. were involved in an accident in 2019. Over 77% of these were considered minor or moderate.
- This CARFAX Vehicle History Report is based only on information supplied to CARFAX and available as of 3/29/26 at 10:08:41 AM (CDT). Other information about this vehicle, including problems, may not have been reported to CARFAX. Use this report as one important tool, along with a vehicle inspection and test drive, to make a better decision about your next used car.

Damage Indicator

Damage can be a result of many different types of events. Examples include contact with objects (other cars, trees, traffic signs, road debris, etc), vandalism, or weather-related events. Not every damage event is reported to CARFAX. As details about the damage event become available, those additional details are added to the CARFAX Vehicle History Report. CARFAX recommends that you have this vehicle inspected by a qualified mechanic.

- This CARFAX Vehicle History Report is based only on information supplied to CARFAX and available as of 3/29/26 at 10:08:41 AM (CDT). Other information about this vehicle, including problems, may not have been reported to CARFAX. Use this report as one important tool, along with a vehicle inspection and test drive, to make a better decision about your next used car.

Damage Severity

Damage events result in one of the following severity levels:

- Minor: Generally, minor damage is cosmetic (including dents or scratches), may only require reconditioning, and typically does not compromise a vehicle's operation and/or safety.
- Moderate: Moderate damage may affect multiple components of the vehicle and may impair the vehicle's operation and/or safety.
- Severe: Severe damage usually affects multiple components of the vehicle and is likely to compromise the vehicle's operation and/or safety.

CARFAX recommends getting a pre-purchase inspection at a certified collision repair facility.

First Owner

When the first owner(s) obtains a title from a Department of Motor Vehicles as proof of ownership.

New Owner Reported

When a vehicle is sold to a new owner, the Title must be transferred to the new owner(s) at a Department of Motor Vehicles.

Ownership History

CARFAX defines an owner as an individual or business that possesses and uses a vehicle. Not all title transactions represent changes in ownership. To provide estimated number of owners, CARFAX proprietary technology analyzes all the events in a vehicle history. Estimated ownership is available for vehicles manufactured after 1991 and titled solely in the US including Puerto Rico. Dealers sometimes opt to take ownership of a vehicle and are required to in the following states: Maine, Massachusetts, New Jersey, Ohio, Oklahoma, Pennsylvania and South Dakota. Please consider this as you review a vehicle's estimated ownership history.

Salvage Title

A Salvage Title is issued on a vehicle damaged to the extent that the cost of repairing the vehicle exceeds approximately 75% of its pre-damage value. This damage threshold may vary by state. Some states treat Junk titles the same as Salvage but the majority use this title to indicate that a vehicle is not road worthy and cannot be titled again in that state. The following eleven states also use Salvage titles to identify stolen vehicles - AZ, FL, GA, IL, MD, MN, NJ, NM, NY, OK and OR.

Title Issued

A state issues a title to provide a vehicle owner with proof of ownership. Each title has a unique number. Each title or registration record on a CARFAX report does not necessarily indicate a change in ownership. In Canada, a registration and bill of sale are used as proof of ownership.

[Full Glossary](#)

Follow Us:



facebook.com/CARFAX



[@CARFAXinc](https://twitter.com/CARFAXinc)



[About CARFAX](#)

CARFAX DEPENDS ON ITS SOURCES FOR THE ACCURACY AND RELIABILITY OF ITS INFORMATION. THEREFORE, NO RESPONSIBILITY IS ASSUMED BY CARFAX OR ITS AGENTS FOR ERRORS OR OMISSIONS IN THIS REPORT. CARFAX FURTHER EXPRESSLY DISCLAIMS ALL WARRANTIES, EXPRESS OR IMPLIED, INCLUDING ANY IMPLIED WARRANTIES OF MERCHANTABILITY OR FITNESS FOR A PARTICULAR PURPOSE.

© 2026 CARFAX, Inc., part of S&P Global. All rights reserved.
3/29/26 10:08:41 AM (CDT)

I have reviewed and received a copy of the CARFAX Vehicle History Report for this 2018 VOLVO V60 vehicle (VIN: YV140MEL5J2384966), which is based on information supplied to CARFAX and available as of 3/29/26 at 11:08 AM (EDT).

Customer Signature

Date

Dealer Signature

Date